

CABLOFIL STEEL WIRE CABLE TRAY PRODUCT TECHNICAL GUIDE



Global strength built on local knowledge

Legrand is the global specialist in electrical and digital building infrastructures. Innovation is the driving force behind its development. With an increasing investment in research and development (circa 5% of sales) and more than 4,000 active patents, the Legrand Group is focused on maintaining a high rate of new product launches that present innovative solutions to the market.

CORPORATE SOCIAL RESPONSIBILITY

Legrand's 2014-2018 CSR roadmap is a natural extension to the governance and sustainable development approach in which the company has been engaged for many years. The CSR roadmap firmly reasserts Legrand's commitment to sustainable development.

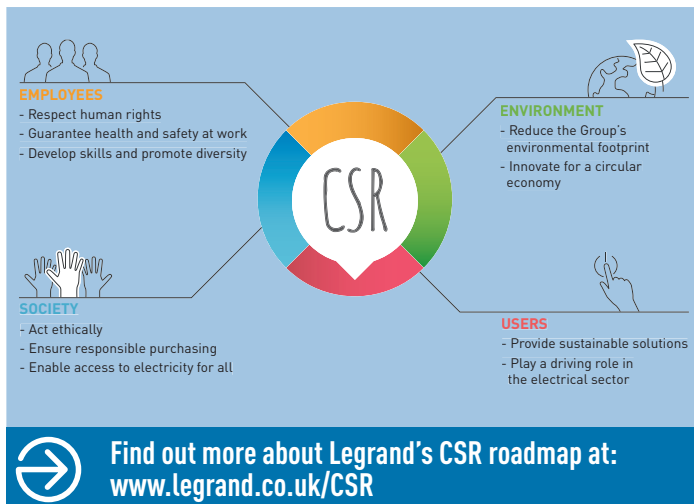

BUILDING SERVICES



INFRASTRUCTURE

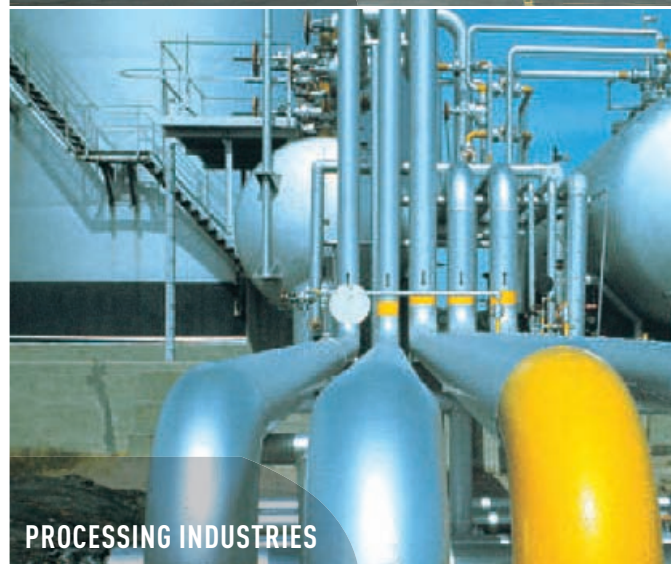

PROCESSING INDUSTRIES



HEAVY INDUSTRIES

INTRODUCTION

Legrand... the cable management expert	2
Cablofil... tried and trusted	3
Cablofil range overview	4
Innovations and specialist solutions	6 - 7

PRODUCT SELECTION

Straight lengths	11 - 15
Dividers and covers	16 - 17
Couplers and fixing kits	18 - 19
Wall mounting	20 - 24
Ceiling mounting	25 - 27
Floor / beam / other mounting	28 - 35

TECHNICAL SPECIFICATIONS

Straight lengths	38 - 45
Dividers and covers	46 - 47
Couplers and fixing kits	48 - 51
Wall mounting	52 - 65
Ceiling mounting	66 - 77
Floor / beam / other mounting	78 - 93

INSTALLATION GUIDE

How to cut steel wire cable tray	96 - 97
Creating radius bends	98 - 103
Fabricating other fittings	104 - 111

DESIGN NOTES

Selecting the right finish	114 - 115
Finishes	116 - 117
Installation of services	118 - 125
Fire resistance and protection	126 - 127

Legrand

the cable
management
expert

Complete cable management solutions

Using its global strength and market leading position, Legrand has developed a complete range of cable management solutions, including:

- **Swifts cable ladder**
- **Swifts cable tray**
- **Salamandre distribution trunking and lighting trunking**
- **Cablofil steel wire cable tray**
- **Floor systems**
- **Perimeter systems**

Specification data for engineering software systems

As part of its ongoing commitment to customer support, Legrand's cable management ranges have been integrated into a number of plant design modelling systems.



Find out more about Legrand's 3D modelling capabilities at: www.legrand3d.co.uk



SWIFTS
CABLE LADDER



SWIFTS
CABLE TRAY

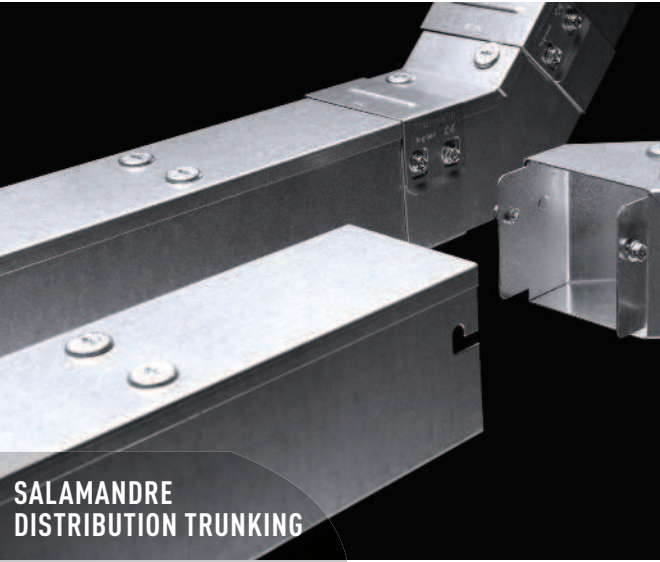

SALAMANDRE
DISTRIBUTION TRUNKING

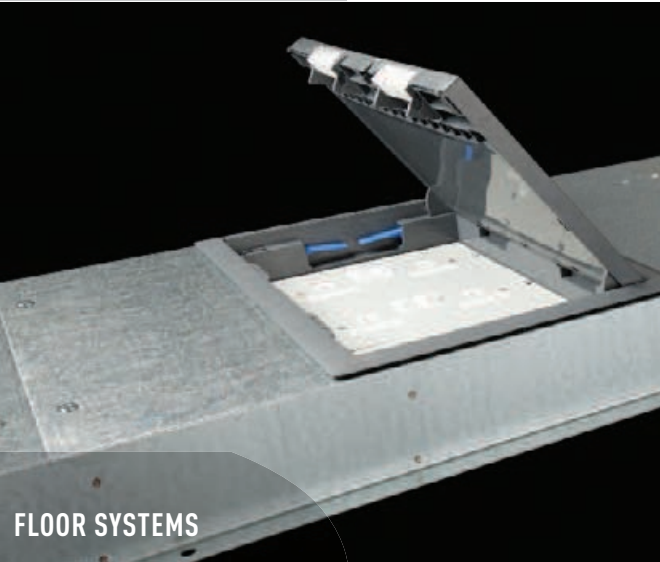

FLOOR SYSTEMS



CABLOFIL STEEL
WIRE CABLE TRAY

Cablofil... trusted for installations large and small

Cablofil steel wire cable tray has been tried and tested in installations of all sizes throughout the UK and beyond, from light duty requirements in small commercial buildings through to extra heavy duty installations in refineries and heavy industry applications such as shipbuilding.



One team. One product portfolio... endless possibilities

As part of Legrand UK's cable management business unit, Cablofil products and systems are supported by a team of experts who live and breathe cable management.

With in-depth knowledge, a vast combined level of experience and a complete cable management product offering at their disposal, our team is able to provide customers with support and advice at any stage of their project, from design through to installation and beyond.



Legrand's market leading Cablofil steel wire cable tray provides a robust, versatile cable management solution for installations of almost any size

- Fast, simple installation
- Easily reconfigured
- Slot and tab boltless system





Designed to be easy to install and configure on site, Cablofil is the UK market leader in steel wire cable tray... an established and popular choice in cable management installations.

CABLOFIL...

the leader in steel wire cable tray

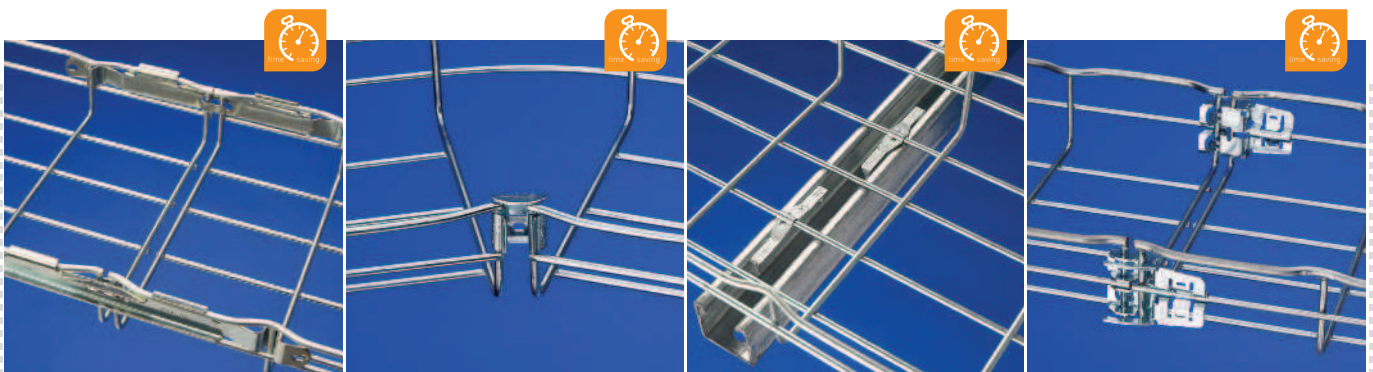

Fast, simple, reliable installations

Cablofil steel wire cable tray is supplied in straight lengths from which sophisticated installations can be created without the need for additional fittings.

Simply cut and shape lengths to form bends, tees, crosspieces etc and secure quickly and easily using a range of 'slot and tab' fixings that do not require nuts and bolts.

- Vast range of supports for wall, ceiling and floor mounting
- Save on installation time with Cablofil's fast fix brackets
- Eradicate the need for nuts and bolts with Cablofil's 'slot and tab' boltless system
- Straight lengths available with pre-fitted couplers for rapid connection
- Natural ventilation provides greater cable efficiency
- Available in several finishes to suit different installation requirements

INNOVATIONS

for easy installations



Fasclic Auto...

The new Fasclic Auto range of 54 mm deep steel wire cable tray is supplied complete with pre-fitted couplers for quick and easy connection of straight lengths. Lengths simply clip together without the need for additional fasteners.



Faslock Auto...

The simple answer to fabricating fittings on site. Create radius bends and reducers in minutes with Faslock Auto. No additional fasteners (or fuss) required.



Specialist solutions

EZ+... increased life expectancy in demanding environments

Potentially corrosive environments such as tunnels, airports and energy production facilities call for tough products that can stand the test of time. Cablofil's latest innovation in surface treatment, EZ+, has been proven to live up to the challenge.

EZ+ is an additional organic finish applied over standard electrozinc plated steel wire cable trays, offering a durable surface treatment for temporary external installations during the construction phase.

In addition to Cablofil's unique rounded wires and T-welded safety edges, the EZ+ coating provides a smooth, consistent surface which further reduces the risk of damage to both the cables and the installer.



EZ-Path[®] ...

EZ-Path is a mechanical device that provides fully compliant fire stopping for power and data cable management pathways.

It's easy to fit and/or retrofit and does not require a specialist fire contractor for system maintenance or upgrades.

Pre-fitted with the optimum amount of intumescent material to stop fire and smoke whether it's filled with cables or completely empty, EZ-Path is the perfect partner to Cablofil steel wire cable tray, Swifts cable ladder and Swifts perforated cable tray.

Find out more about EZ-Path at www.legrand.co.uk

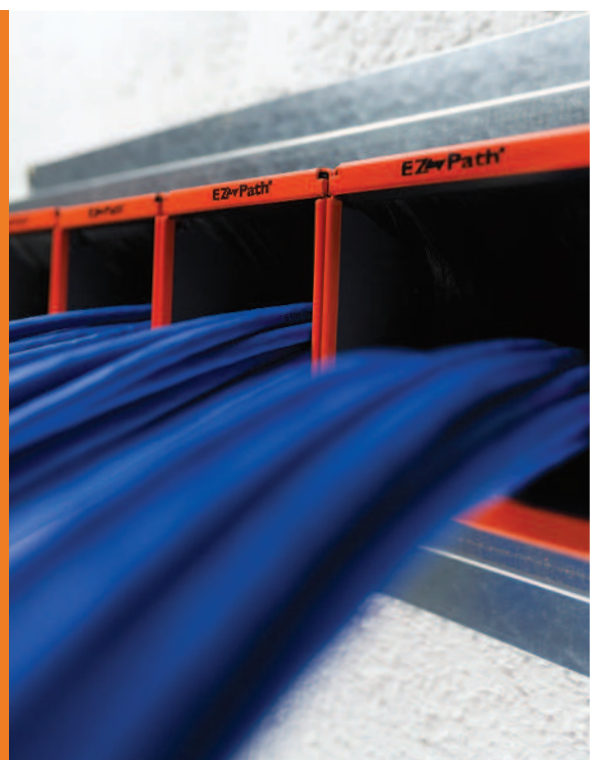



product selection

PRODUCT SELECTION

STRAIGHT LENGTHS / DIVIDERS / COVERS

30 mm deep tray (CF30) / 54 mm deep tray (CF54)	11
FASCLIC AUTO (FCFA54) / FASCLIC (FCF54)	12
80 mm (CF80) / 105 mm (CF105) / 150 mm (CF150) deep tray	13
G-tray (CFG) / underfloor tray (UF30)	14
Mini tray (TXF35) / flexible tray (G-MINI)	15
Straight length dividers (COT) / bend dividers (COTFIL)	16
Covers (CVN / CP) / cover clips (F01/02/03)	17

COUPLERS AND FIXING KITS

Length to length couplers (EDRN / AUTOCLIC)	18
Joint strips (ED275 / ED1100)	18
Connectors (FASLOCK AUTO / FASSTRUT 41)	18
Base couplers (CEFAS / R15/25/35)	18
Fixing kits and components	19

WALL MOUNTING

Base and side wire mounting (UC50 / CAT30 / CAT40 / CM50 / CM50XL)	20
Cantilever arms (CSN / CSNC / CG / CB / CU / CLN / CC21S)	21 - 23
Stand-off brackets (R15/25/35/55)	23
Fast fix support rails (RCSN) / mounting rails (EDF / RE41SP)	24

CEILING MOUNTING

Central hangers (SF50/100 / SL50 / CEQ / UC50 / SAS / CE40 / CM50XL / SCF / UCS)	25 - 26
Trapeze hangers (AS / RCSN / EDF)	26 - 27
Profile mounting (CSNC)	26
Pendant mounting (EDF / PFREDF / RE41SP / PFR41S)	27

FLOOR / BEAM / OTHER MOUNTING

Floor mounting (CM50XL / RCSN / R15/25/35/55 / FTX / UC50 / UFC)	28 - 29
Beam mounting (CLMFAS / CLMU / EF)	29
Take-off plates (SBDN / SBD / EXSBD)	30
Universal mounting plates (CM50 / CM50XL / CAT40 / CM50XXL / CM50WL)	31
Luminaire supports (SL50/100)	32
Multifix base plates (MFM / MFPOLYA)	32
Cabling accessories (FAS ROLLER / DEV100 / CLIP / PA)	33
Earthing (BLF / GRIFEQUIP / GRIFEQUIP 2)	34
Fixings / fasteners / ancillary items	35

Cablofil®
key to finishes and symbols

■ Key to finishes

Symbol	Description
GS	Pre-galvanised
EZ	Electrogalvanising after manufacture
EZ+	Organically coated electrogalvanised after manufacture
GC	Hot dip galvanised after manufacture
DC	Geomet®
304L	Stainless steel 304 L
316L	Stainless steel 316 L
Z+	Continuous galvanisation before manufacture

For detailed information related to finishes, refer to p. 116-117

■ Recommended finishes for different environments

○ Recommended ◆ Possible	GS	EZ	EZ+	GC	DC	304L	316L
Internal installation, normal environment	○	○					
External installation, urban environment	◆	◆	◆	○	○		
Temporary external installation during construction phase	◆	◆	○				
Chemical industries, nitrate explosives, photography, decoration				◆	◆		○
Marine, harsh, sulphurous (weak concentration) environments				◆	◆		○
Acid or alkaline environments		◆		◆	◆	○	◆
Food production environment					○	○	
Halogen environment						◆	○

Typical atmospheric environments in relation to suitability of finishes

■ Colour code identification



The surface treatment can be identified by a colour coded clip
Each colour corresponds with a particular finish, i.e. yellow clip = EZ

■ Key to symbols

Symbol	Description
	Fixing without nuts and bolts
	Fixing with nuts and bolts
	Fast assembling
	Patented fast assembling system (FAS)
	Patented
	Patented safety edge
P1500	Supports at 1.5 m span
P2000	Supports at 2.0 m span
W	Width
L	Length
H↑	Height
	Practical safety load in daN
	Coupling

straight lengths – CF30

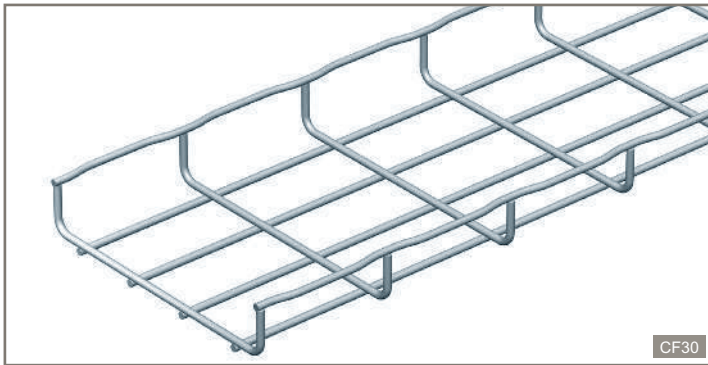

straight lengths – CF54

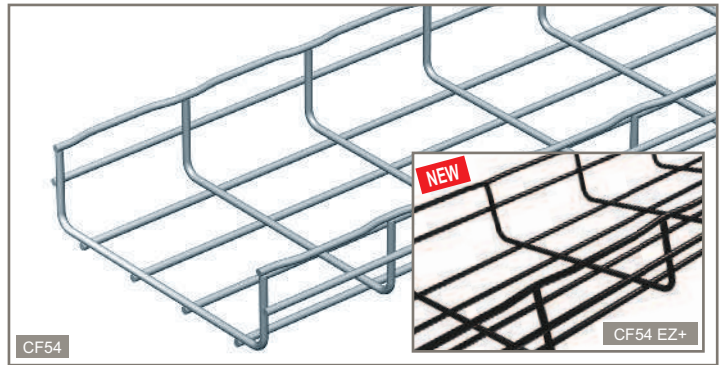

Loading graphs p. 38
Dimensions and technical information p. 38

NOTE : please use Cat. No. when placing your order

Pack	Cat. Nos.		CF30 – straight lengths (3 m)	
	EZ	GC	↓↑ 30 mm ↔ 50 mm → 600 mm ↔ 3 m	
				Width (mm)
1	CM000011	CM000013	CF30/50*	50
1	CM000021	CM000023	CF30/100	100
1	CM000031	CM000033	CF30/150	150
1	CM000041	CM000043	CF30/200	200
1	CM000051	CM000053	CF30/300	300
1	CM000801	–	CF30/400	400
1	CM000831	–	CF30/450	450
1	CM000811	–	CF30/500	500
1	CM000851	–	CF30/600	600

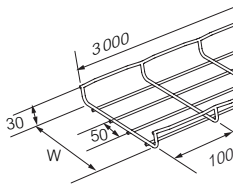

Loading graphs p. 39
Dimensions and technical information p. 39

NOTE : please use Cat. No. when placing your order

Pack	Cat. Nos.		CF54 – straight lengths (3 m)	
	EZ	GC	↓↑ 54 mm ↔ 50 mm → 600 mm ↔ 3 m	
				Width (mm)
1	CM000061	CM000063	CF54/50	50
1	CM000071	CM000073	CF54/100	100
1	CM000081	CM000083	CF54/150	150
1	CM000091	CM000093	CF54/200	200
1	CM000101	CM000103	CF54/300	300
1	CM000201	CM000203	CF54/400	400
1	CM000251	CM000253	CF54/450	450
1	CM000301	CM000303	CF54/500	500
1	CM000401	CM000403	CF54/600	600

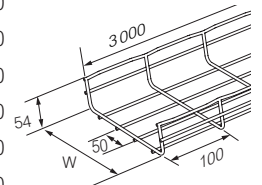

		CF 30 stainless steel – straight lengths (3 m)	
	304L	316L	↓↑ 30 mm ↔ 50 mm → 300 mm ↔ 3 m
			Width (mm)
1	CM000018	CM000014	CF30/50*
1	CM000028	CM000024	CF30/100
1	CM000038	CM000034	CF30/150
1	CM000048	CM000044	CF30/200
1	CM000058	CM000054	CF30/300



		CF54 stainless steel – straight lengths (3 m)	
	304L	316L	↓↑ 54 mm ↔ 50 mm → 600 mm ↔ 3 m
			Width (mm)
1	CM000068	CM000064	CF54/50
1	CM000078	CM000074	CF54/100
1	CM000088	CM000084	CF54/150
1	CM000098	CM000094	CF54/200
1	CM000108	CM000104	CF54/300
1	CM000208	CM000204	CF54/400
1	CM000258	CM000254	CF54/450
1	CM000308	CM000304	CF54/500
1	CM000408	CM000404	CF54/600

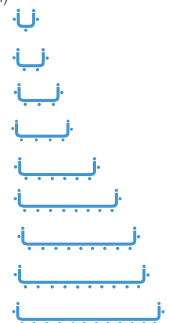

1 : = No safety edge

		CF54 EZ+ – straight lengths (3 m)	
	NEW	EZ+	↓↑ 54 mm ↔ 50 mm → 600 mm ↔ 3 m
			Colour : black
			Width (mm)
1	CM000062	CF54/50	50
1	CM000072	CF54/100	100
1	CM000082	CF54/150	150
1	CM000092	CF54/200	200
1	CM000102	CF54/300	300
1	CM000202	CF54/400	400
1	CM000252	CF54/450	450
1	CM000302	CF54/500	500
1	CM000402	CF54/600	600

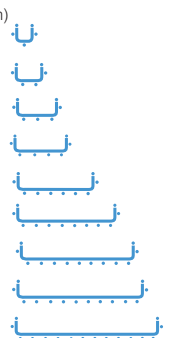

Key :			
EZ	Electrogalvanising after manufacture	304L	Stainless steel 304L
EZ+	Organically coated electrogalvanised after manufacture	316L	Stainless steel 316L
GC	Hot dip galvanised after manufacture		

For detailed information related to finishes, refer to p. 116-117

All dimensions (mm) are nominal

NEW

straight lengths – FCFA54 (FASCLIC AUTO)

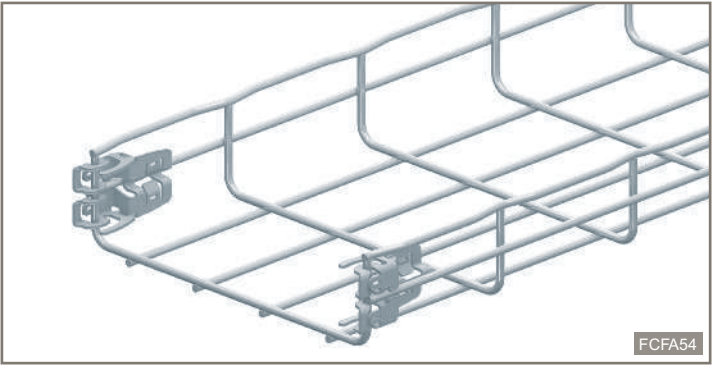

FCFA54

straight lengths – FCF54 (FASCLIC)

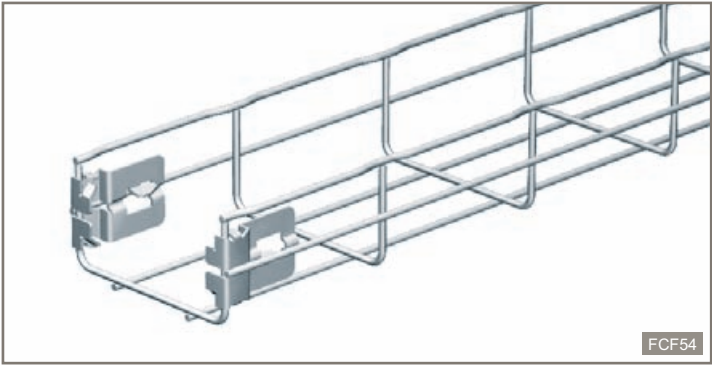

FCF54

Loading graphs **p. 40**
Dimensions and technical information **p. 40**

NOTE : please use Cat. No. when placing your order

Pack	Cat. Nos.		FCFA54 – straight lengths (3 m)	
	EZ	GC	⬆️⬆️ 54 mm ⬆️⬆️ 50 mm → 600 mm ⬆️⬆️ 3 m	
				Width (mm)
1	CM082061	-	FCFA54/50	50
1	CM082071	-	FCFA54/100	100
1	CM082081	-	FCFA54/150	150
1	CM082091	-	FCFA54/200	200
1	CM082101	-	FCFA54/300	300
1	CM082201	-	FCFA54/400	400
1	CM082251	-	FCFA54/450	450
1	CM082301	-	FCFA54/500	500
1	CM082401	-	FCFA54/600	600

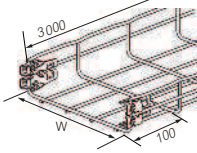

Loading graphs **p. 41**
Dimensions and technical information **p. 41**

NOTE : please use Cat. No. when placing your order

Pack	Cat. Nos.		FCF54 stainless steel – straight lengths (3 m)	
	304L	316L	⬆️⬆️ 54 mm ⬆️⬆️ 50 mm → 300 mm ⬆️⬆️ 3 m	
				Width (mm)
1	CM081068	CM081064	FCF54/50	50
1	CM081078	CM081074	FCF54/100	100
1	CM081088	CM081084	FCF54/150	150
1	CM081098	CM081094	FCF54/200	200
1	-	CM081104	FCF54/300	300

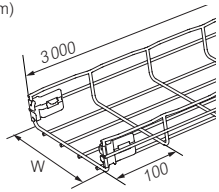

Key :

- Electrogalvanising after manufacture
- Stainless steel 304L
- Stainless steel 316L

For detailed information related to finishes, refer to **p. 116-117**

All dimensions (mm) are nominal

straight lengths – CF105

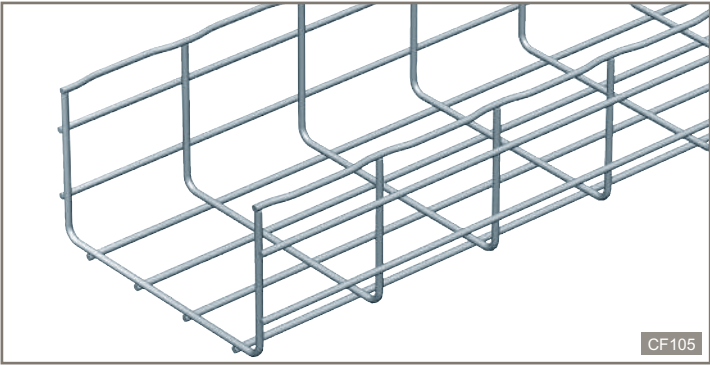

straight lengths – CF80 - CF150

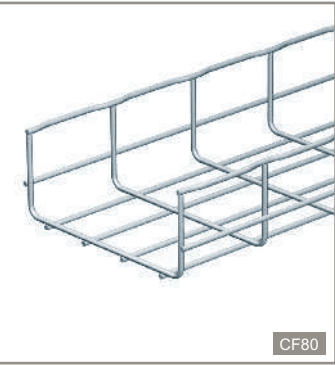

Loading graphs p. 42
Dimensions and technical information p. 42

NOTE : please use Cat. No. when placing your order

Loading graphs p. 43
Dimensions and technical information p. 43

NOTE : please use Cat. No. when placing your order

Pack	Cat. Nos.		CF105 – straight lengths (3 m)	
	EZ	GC	$\downarrow \uparrow$ 105 mm	$\leftarrow \rightarrow$ 100 mm \rightarrow 600 mm \rightleftarrows 3 m
			Width (mm)	
1	CM000891	CM000893	CF105/100	100
1	CM000901	CM000903	CF105/150	150
1	CM000911	CM000913	CF105/200	200
1	CM000921	CM000923	CF105/300	300
1	CM000931	CM000933	CF105/400	400
1	CM001931	CM001933	CF105/450	450
1	CM000941	CM000943	CF105/500	500
1	CM001031	CM001033	CF105/600	600

Pack	Cat. Nos.		CF80 – straight lengths (3 m)	
	EZ	GC	$\downarrow \uparrow$ 80 mm	$\leftarrow \rightarrow$ 100 mm \rightarrow 500 mm \rightleftarrows 3 m
			Width (mm)	
1	CM800101	CM800103	CF80/100	100
1	CM800201	CM800203	CF80/200	200
1	CM800301	CM800303	CF80/300	300
1	CM800401	CM800403	CF80/400	400
1	CM800501	CM800503	CF80/500	500

Pack	Cat. Nos.		CF105 stainless steel – straight lengths (3 m)	
	304L	316L	$\downarrow \uparrow$ 105 mm	$\leftarrow \rightarrow$ 100 mm \rightarrow 600 mm \rightleftarrows 3 m
			Width (mm)	
1	CM000898	CM000894	CF105/100	100
1	CM000908	CM000904	CF105/150	150
1	CM000918	CM000914	CF105/200	200
1	CM000928	CM000924	CF105/300	300
1	CM000938	CM000934	CF105/400	400
1	CM001938	CM001934	CF105/450	450
1	CM000948	CM000944	CF105/500	500
1	CM001038	CM001034	CF105/600	600

Pack	Cat. Nos.		CF150 – straight lengths (3 m)	
	EZ	GC	$\downarrow \uparrow$ 150 mm	$\leftarrow \rightarrow$ 200 mm \rightarrow 500 mm \rightleftarrows 3 m
			Width (mm)	
1	CM000951	CM000953	CF150/200	200
1	CM000961	CM000963	CF150/300	300
1	CM000971	CM000973	CF150/400	400
1	CM001011	CM001013	CF150/450	450
1	CM001021	CM001023	CF150/500	500

Key :

- Electrogalvanising after manufacture
- Stainless steel 304L
- Hot dip galvanised after manufacture
- Stainless steel 316L

For detailed information related to finishes, refer to p. 116-117

All dimensions (mm) are nominal

straight lengths – CFG

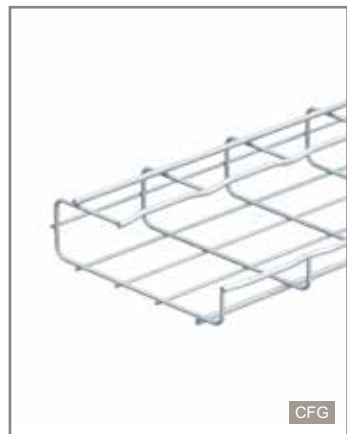

CFG

Dimensions and technical information **p. 44**

NOTE : please use Cat. No. when placing your order

Pack	Cat. Nos.		CFG – straight lengths (3 m)		
	EZ	GC	Height (mm)	Width (mm)	
1	CM003221	CM003223	50	100	
1	CM003231	CM003233	50	150	
1	CM003241	CM003243	50	200	

straight lengths – UF30
for underfloor, light duty applications

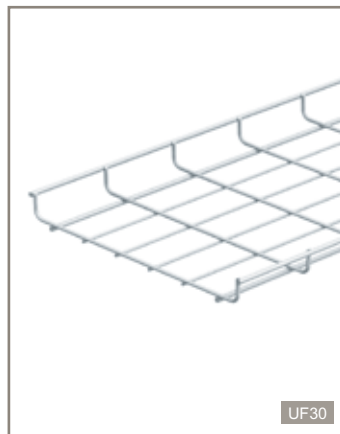

UF30

Dimensions and technical information **p. 44**

NOTE : please use Cat. No. when placing your order

Pack	Cat. Nos.		UF30 – straight lengths (3 m)		
	EZ	GC	Height (mm)	Width (mm)	
1	CM430161	–	30	300	
1	CM430181	–	30	400	
1	CM430201	–	30	500	

Key :

- EZ** Electrogalvanising after manufacture
- GC** Hot dip galvanised after manufacture

For detailed information related to finishes, refer to **p. 116-117**

All dimensions (mm) are nominal

mini steel wire cable tray – TXF35

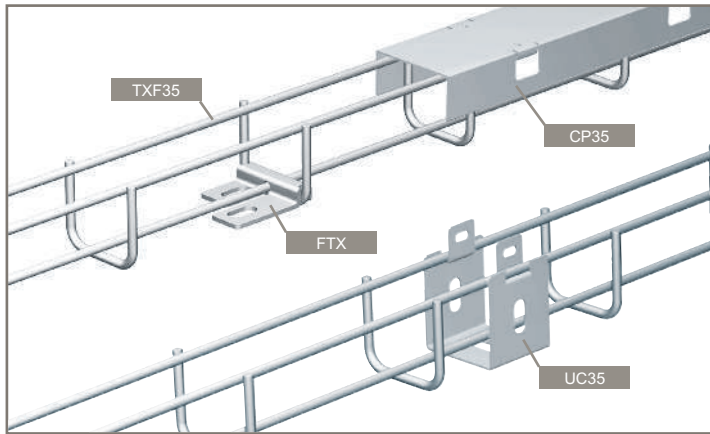

Dimensions and technical information p. 45

NOTE : please use Cat. No. when placing your order

Pack	Cat. Nos.		
1	EZ CM755001	GC CM755003	304L CM755008
1		316L CM755004	

TXF35 – straight lengths (3 m)

Pack	Cat. Nos.		
1	GS CM755100	GC CM755103	316L CM755104

CP35 – covers

Pack	Cat. Nos.		
1	GS CM586160	GC CM586163	316L CM586164

UC35 – base fixing plates

Pack	Cat. Nos.		
1	GS CM586180	DC CM586183	316L CM586184

FTX – base fixing plates

flexible steel wire cable tray – G-MINI

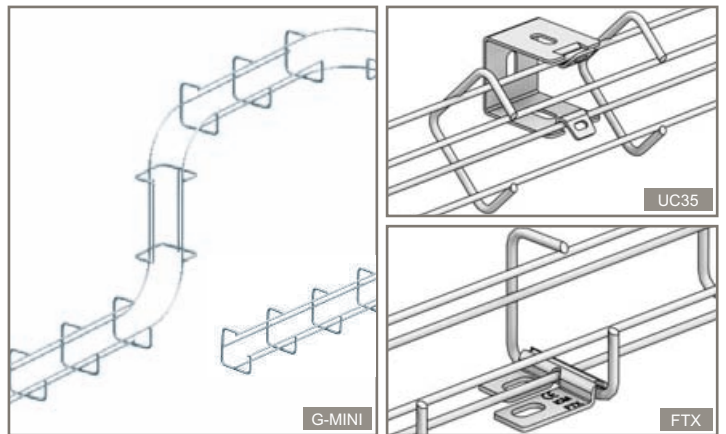

Dimensions and technical information p. 45

NOTE : please use Cat. No. when placing your order

Pack	Cat. Nos.		
1	EZ CM430111	GC -	316L CM430114

G-MINI – straight lengths (3 m)

Pack	Cat. Nos.		
1	GS CM586160	GC CM586163	316L CM586164

UC35 – base fixing plates

Pack	Cat. Nos.		
1	GS CM586180	DC CM586183	316L CM586184

FTX – base fixing plates

Key :	EZ Electrogalvanising after manufacture	GS Pre-galvanised	GC Hot dip galvanised after manufacture	304L Stainless steel 304L	316L Stainless steel 316L
	For detailed information related to finishes, refer to p. 116-117				

All dimensions (mm) are nominal

straight length dividers – COT / COT J



COT/COTJ

Dimensions and technical information **p. 46**

NOTE : please use Cat. No. when placing your order

Pack	Cat. Nos.			COT – dividers (3 m)	
				$\downarrow \uparrow 30 \rightarrow 105 \text{ mm}$ $\leftarrow \rightarrow 100 \rightarrow 600 \text{ mm}$	
	GS	GC	316L		
1	CM923010	CM923013	CM923014	For tray depth 30 mm (CF30) COT30	H mm 24
1	CM923020	CM923023	CM923024	For tray depth 54 mm (CF54) COT50	48
1	CM923030	CM923033	–	For tray depth 80 mm (CF80) COT75	72
1	CM923040	CM923043	CM923044	For tray depth 105 mm (CF105) COT100	96

Pack	Cat. Nos.			COT J – divider connectors	
				$\downarrow \uparrow 30 \rightarrow 105 \text{ mm}$ $\leftarrow \rightarrow 100 \rightarrow 600 \text{ mm}$	
	GS	GC	316L		
1	CM923050	–	CM923054		

bend dividers – COTFIL

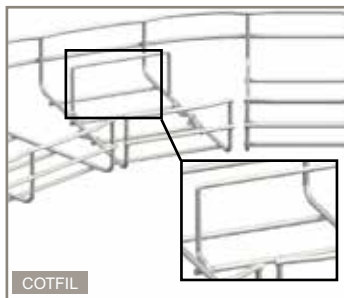

COTFIL

Dimensions and technical information **p. 46**

NOTE : please use Cat. No. when placing your order

Pack	Cat. Nos.			COTFIL – bend dividers	
				$\downarrow \uparrow 30 \rightarrow 105 \text{ mm}$ $\leftarrow \rightarrow 100 \rightarrow 600 \text{ mm}$	
	EZ	GC	304L		
1	CM586711	–	CM586718	For tray depth 30 mm (CF30) COTFIL30	H mm 24
1	CM586721	–	CM586728	For tray depth 54 mm (CF54) COTFIL50	44
1	CM586731	–	CM586738	For tray depth 80 mm (CF80) COTFIL75	71
1	CM586741	–	CM586748	For tray depth 105 mm (CF105) COTFIL100	94

Key :	EZ Electrogalvanising after manufacture	304L Stainless steel 304L
	GS Pre-galvanised	316L Stainless steel 316L
	GC Hot dip galvanised after manufacture	For detailed information related to finishes, refer to p. 116-117

All dimensions (mm) are nominal

covers and clips – CVN - CP - F01 - F02 - F03

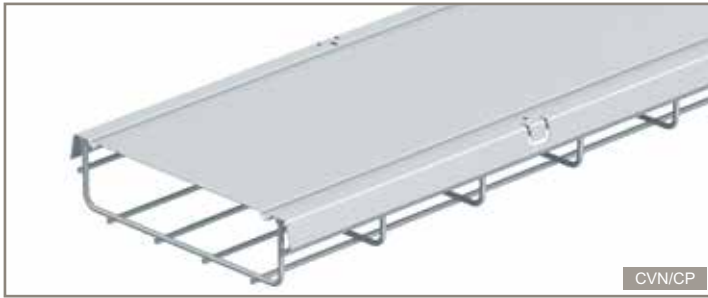

CVN/CP



F01

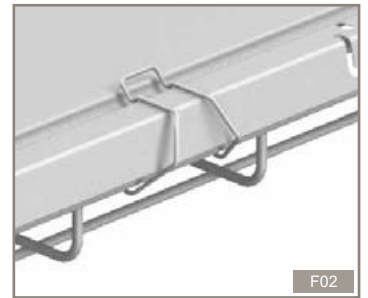

F02

Dimensions and technical information p. 47

NOTE : please use Cat. No. when placing your order

NOTE : please use Cat. No. when placing your order

Pack	Cat. Nos.		CVN – covers	
			$\downarrow \uparrow 30 \rightarrow 105 \text{ mm}$ $\leftarrow \rightarrow 50 \rightarrow 600 \text{ mm}$ $\rightleftarrows 1 \text{ m}$	Supplied in packs of 3 x 1 m lengths
	GS	GC	Width (mm)	
1	CM629050	CM629053	CVN50	50
1	CM629100	CM629103	CVN100	100
1	CM629150	CM629153	CVN150	150
1	CM629200	CM629203	CVN200	200
1	CM629300	CM629303	CVN300	300
1	CM629400	CM629403	CVN400	400
1	CM629450	CM629453	CVN450	450
1	CM629500	CM629503	CVN500	500
1	CM629600	CM629603	CVN600	600

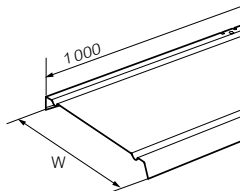

Pack	Cat. Nos.		CP stainless steel – covers	
			$\downarrow \uparrow 30 \rightarrow 105 \text{ mm}$ $\leftarrow \rightarrow 50 \rightarrow 600 \text{ mm}$ $\rightleftarrows 2 \text{ m}$	Supplied in packs of 1 x 2 m lengths
	304L	316L	Width (mm)	
1	-	CM646014	CP50	50
1	-	CM646024	CP100	100
1	-	CM646034	CP150	150
1	-	CM646044	CP200	200
1	-	CM646054	CP300	300
1	-	CM646064	CP400	400
1	-	CM646094	CP450	450
1	-	CM646074	CP500	500
1	-	CM646084	CP600	600

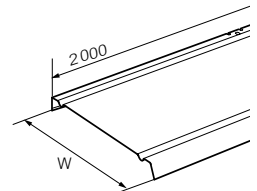

Pack	Cat. Nos.		CVN stainless steel – covers	
			$\downarrow \uparrow 30 \rightarrow 105 \text{ mm}$ $\leftarrow \rightarrow 50 \rightarrow 200 \text{ mm}$ $\rightleftarrows 1 \text{ m}$	Supplied in packs of 3 x 1 m lengths
	304L	316L	Width (mm)	
1	CM629058	CM629054	CVN50	50
1	CM629108	CM629104	CVN100	100
1	-	CM629154	CVN150	150
1	-	CM629204	CVN200	200

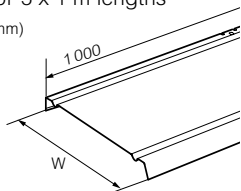

Pack	Cat. Nos.		F01 – cover clip	
	GS	316L	For 30 mm tray (CF30)	
25	CM646220	CM646224		



Pack	Cat. Nos.		F02 – cover clip	
	GS	316L	For 54 mm tray (CF54) and 105 mm tray (CF105)	
25	CM646200	CM646204		



Pack	Cat. Nos.		CP – covers	
			$\downarrow \uparrow 30 \rightarrow 105 \text{ mm}$ $\leftarrow \rightarrow 50 \rightarrow 600 \text{ mm}$ $\rightleftarrows 2 \text{ m}$	Supplied in packs of 1 x 2 m lengths
	GS	GC	Width (mm)	
1	CM646010	CM646013	CP50	50
1	CM646020	CM646023	CP100	100
1	CM646030	CM646033	CP150	150
1	CM646040	CM646043	CP200	200
1	CM646050	CM646053	CP300	300
1	CM646060	CM646063	CP400	400
1	CM646090	CM646093	CP450	450
1	CM646070	CM646073	CP500	500
1	CM646080	CM646083	CP600	600

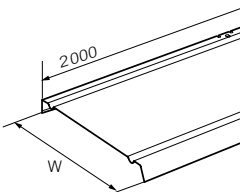

Pack	Cat. Nos.		F03 – cover clip	
	GS	316L	For 80 mm tray (CF80)	
25	CM646210	-		



Key :	GS Pre-galvanised	304L Stainless steel 304L
	GC Hot dip galvanised after manufacture	316L Stainless steel 316L

For detailed information related to finishes, refer to p. 116-117

All dimensions (mm) are nominal

couplers and connectors – EDRN - AUTOCLIC - ED275/1100 - FASLOCK AUTO - CEFAS - R15/25/35

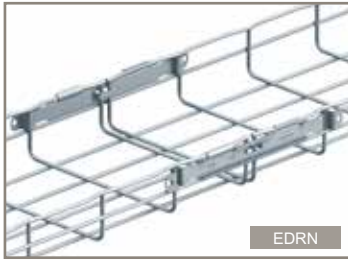

EDRN

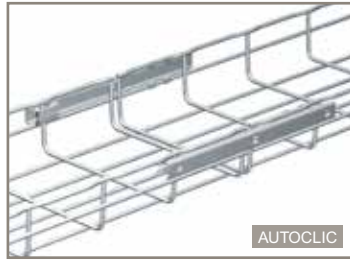

AUTOCLIC

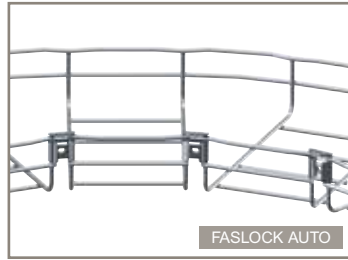

FASLOCK AUTO



CEFAS

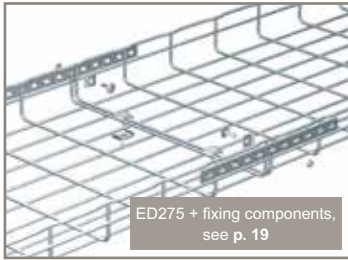

ED275 + fixing components, see p. 19



R15/25/35 – wall mounting

 Dimensions and technical information p. 48-51

NOTE : please use Cat. No. when placing your order

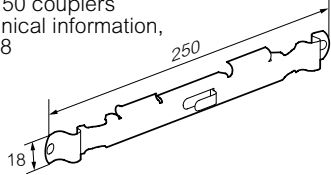
Pack	Cat. Nos.	EDRN – couplers				
50	<table border="0"> <tr> <td>EZ</td> <td>DC</td> </tr> <tr> <td>CM558241</td> <td>CM558247</td> </tr> </table>	EZ	DC	CM558241	CM558247	<p>↕ 30 → 150 mm ↔ 50 → 600 mm Supplied with one fixing tool in each pack of 50 couplers For technical information, see p. 48</p> 
EZ	DC					
CM558241	CM558247					
50	<table border="0"> <tr> <td>304L</td> <td>316L</td> </tr> <tr> <td>-</td> <td>CM558244</td> </tr> </table>	304L	316L	-	CM558244	
304L	316L					
-	CM558244					

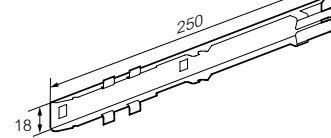
Pack	Cat. Nos.	AUTOCLIC – couplers				
50	<table border="0"> <tr> <td>GS</td> <td>GC</td> </tr> <tr> <td>CM558280</td> <td>CM558283</td> </tr> </table>	GS	GC	CM558280	CM558283	<p>↕ 54 / 105 mm ↔ 50 → 600 mm Rapid fit with screwdriver (not included) For technical information, see p. 48</p> 
GS	GC					
CM558280	CM558283					
50	<table border="0"> <tr> <td>304L</td> <td>316L</td> </tr> <tr> <td>CM558288</td> <td>CM558284</td> </tr> </table>	304L	316L	CM558288	CM558284	
304L	316L					
CM558288	CM558284					

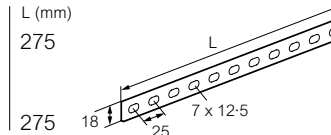
Pack	Cat. Nos.	ED275 – joint strips							
50	<table border="0"> <tr> <td>EZ</td> <td>GC</td> </tr> <tr> <td>CM558221</td> <td>CM558223</td> </tr> </table>	EZ	GC	CM558221	CM558223	<p>↕ 54 / 105 / 150 mm ↔ 50 → 600 mm For technical information, see p. 49</p> <table border="0"> <tr> <td>ED275</td> <td>L (mm)</td> <td>275</td> </tr> </table> 	ED275	L (mm)	275
EZ	GC								
CM558221	CM558223								
ED275	L (mm)	275							
1	<table border="0"> <tr> <td>304L</td> <td>316L</td> </tr> <tr> <td>CM558228</td> <td>CM558224</td> </tr> </table>	304L	316L	CM558228	CM558224	<table border="0"> <tr> <td>ED275</td> <td>L (mm)</td> <td>275</td> </tr> </table>	ED275	L (mm)	275
304L	316L								
CM558228	CM558224								
ED275	L (mm)	275							

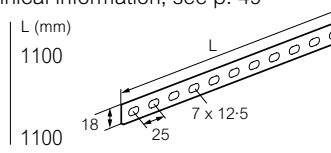
Pack	Cat. Nos.	ED1100 – joint strips							
1	<table border="0"> <tr> <td>EZ</td> <td>GC</td> </tr> <tr> <td>CM558201</td> <td>CM558203</td> </tr> </table>	EZ	GC	CM558201	CM558203	<p>↕ 54 / 105 / 150 mm ↔ 50 → 600 mm For technical information, see p. 49</p> <table border="0"> <tr> <td>ED1100</td> <td>L (mm)</td> <td>1100</td> </tr> </table> 	ED1100	L (mm)	1100
EZ	GC								
CM558201	CM558203								
ED1100	L (mm)	1100							
1	<table border="0"> <tr> <td>304L</td> <td>316L</td> </tr> <tr> <td>-</td> <td>CM558204</td> </tr> </table>	304L	316L	-	CM558204	<table border="0"> <tr> <td>ED1100</td> <td>L (mm)</td> <td>1100</td> </tr> </table>	ED1100	L (mm)	1100
304L	316L								
-	CM558204								
ED1100	L (mm)	1100							

Key :	EZ Electrogalvanising after manufacture	DC Geomet
	GS Pre-galvanised	304L Stainless steel 304L
	GC Hot dip galvanised after manufacture	316L Stainless steel 316L
	Z+ Continuous galvanisation before manufacture	For detailed information related to finishes, refer to p. 116-117

NOTE : please use Cat. No. when placing your order

Pack	Cat. Nos.	FASLOCK AUTO – connectors				
25	<table border="0"> <tr> <td>EZ</td> <td>DC</td> </tr> <tr> <td>CM558340</td> <td>CM558347</td> </tr> </table>	EZ	DC	CM558340	CM558347	<p>↕ 30 → 150 mm ↔ 100 → 600 mm For technical information, see p. 49</p> <p>FASLOCK S ↔ 100 → 200 mm</p>
EZ	DC					
CM558340	CM558347					
25	<table border="0"> <tr> <td>CM558320</td> <td>CM558327</td> </tr> </table>	CM558320	CM558327	FASLOCK XL ↔ 300 → 600 mm		
CM558320	CM558327					
25	<table border="0"> <tr> <td>304L</td> <td>316L</td> </tr> <tr> <td>-</td> <td>CM558344</td> </tr> </table>	304L	316L	-	CM558344	FASLOCK S ↔ 100 → 200 mm
304L	316L					
-	CM558344					
25	<table border="0"> <tr> <td>-</td> <td>CM558324</td> </tr> </table>	-	CM558324	FASLOCK XL ↔ 300 → 600 mm		
-	CM558324					

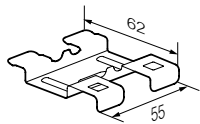

Pack	Cat. Nos.	CEFAS – base couplers				
50	<table border="0"> <tr> <td>GS</td> <td>DC</td> </tr> <tr> <td>CM558410</td> <td>CM558417</td> </tr> </table>	GS	DC	CM558410	CM558417	<p>↕ 30 → 150 mm ↔ 100 → 600 mm For technical information, see p. 50</p> 
GS	DC					
CM558410	CM558417					
50	<table border="0"> <tr> <td>304L</td> <td>316L</td> </tr> <tr> <td>-</td> <td>CM558414</td> </tr> </table>	304L	316L	-	CM558414	
304L	316L					
-	CM558414					

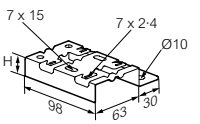
Pack	Cat. Nos.	R15 / R25 / R35 – stand-off brackets																								
1	<table border="0"> <tr> <td>GS</td> <td>Z+</td> </tr> <tr> <td>CM586170</td> <td>CM586173</td> </tr> </table>	GS	Z+	CM586170	CM586173	<p>↕ 30 → 105 mm ↔ 100 → 600 mm For technical information, see p. 50</p> <table border="0"> <tr> <td>R15/100</td> <td>H (mm)</td> <td>15</td> <td>daN</td> <td>100</td> </tr> <tr> <td>R15/300</td> <td>H (mm)</td> <td>15</td> <td>100</td> <td></td> </tr> <tr> <td>R25</td> <td>H (mm)</td> <td>25</td> <td>100</td> <td></td> </tr> <tr> <td>R35</td> <td>H (mm)</td> <td>35</td> <td>100</td> <td></td> </tr> </table> 	R15/100	H (mm)	15	daN	100	R15/300	H (mm)	15	100		R25	H (mm)	25	100		R35	H (mm)	35	100	
GS	Z+																									
CM586170	CM586173																									
R15/100	H (mm)	15	daN	100																						
R15/300	H (mm)	15	100																							
R25	H (mm)	25	100																							
R35	H (mm)	35	100																							
1	<table border="0"> <tr> <td>304L</td> <td>316L</td> </tr> <tr> <td>-</td> <td>CM586174</td> </tr> </table>	304L	316L	-	CM586174	<table border="0"> <tr> <td>R15/100</td> <td>H (mm)</td> <td>15</td> <td>100</td> </tr> </table>	R15/100	H (mm)	15	100																
304L	316L																									
-	CM586174																									
R15/100	H (mm)	15	100																							

All dimensions (mm) are nominal

**channel strut clips – FASTRUT 41 / CE40
fixing components – CE25/CE30**

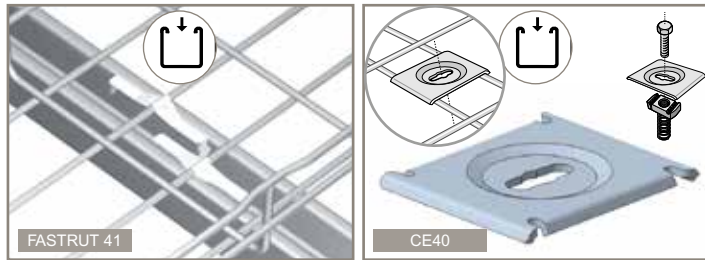

fixing kits – KITS

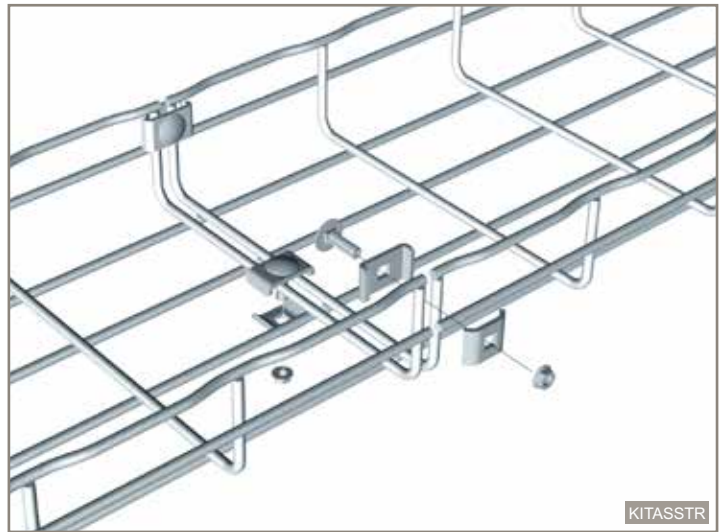

Dimensions and technical information p. 48-51

NOTE : please use Cat. No. when placing your order

Pack	Cat. Nos.	FASTRUT 41 – channel strut clip								
50	<table border="1"> <tr> <td>DC</td> <td>316L</td> </tr> <tr> <td>CM599007</td> <td>CM599004</td> </tr> </table>	DC	316L	CM599007	CM599004	⤴ 30 / 54 / 105 mm ⤵ 100 → 600 mm Use to secure steel wire cable tray to channel section or channel type cantilever arms For technical information, see p. 51				
DC	316L									
CM599007	CM599004									
		CE40 – hold down clamps								
		⤴ 30 → 150mm ⤵ 100 → 600 mm For technical information, see p. 69								
25	<table border="1"> <tr> <td>EZ</td> <td>DC</td> </tr> <tr> <td>CM558051</td> <td>CM558053</td> </tr> <tr> <td>304L</td> <td>316L</td> </tr> <tr> <td>CM558058</td> <td>CM558054</td> </tr> </table>	EZ	DC	CM558051	CM558053	304L	316L	CM558058	CM558054	100
EZ	DC									
CM558051	CM558053									
304L	316L									
CM558058	CM558054									

Pack	Cat. Nos.	CE25 / CE30 – fixing components				
100	<table border="1"> <tr> <td>EZ</td> <td>DC</td> </tr> <tr> <td>CM801011</td> <td>CM801017</td> </tr> </table>	EZ	DC	CM801011	CM801017	BTRCC 6 x 20
EZ	DC					
CM801011	CM801017					
50	<table border="1"> <tr> <td>CM558011</td> <td>CM558013</td> </tr> </table>	CM558011	CM558013	CE25 		
CM558011	CM558013					
50	<table border="1"> <tr> <td>CM558041</td> <td>CM558043</td> </tr> </table>	CM558041	CM558043	CE30 		
CM558041	CM558043					

Pack	Cat. Nos.	CE25 / CE30 stainless steel – fixing components				
100	<table border="1"> <tr> <td>304L</td> <td>316L</td> </tr> <tr> <td>CM801018</td> <td>CM801014</td> </tr> </table>	304L	316L	CM801018	CM801014	BTRCC 6 x 20
304L	316L					
CM801018	CM801014					
50	<table border="1"> <tr> <td>CM558018</td> <td>CM558014</td> </tr> </table>	CM558018	CM558014	CE25 		
CM558018	CM558014					
50	<table border="1"> <tr> <td>CM558048</td> <td>CM558044</td> </tr> </table>	CM558048	CM558044	CE30 		
CM558048	CM558044					

Dimensions and technical information p. 51

NOTE : please use Cat. No. when placing your order

Pack	Cat. Nos.	KITS – fixing kits				
50	<table border="1"> <tr> <td>EZ</td> <td>DC</td> </tr> <tr> <td>CM558081</td> <td>CM558087</td> </tr> </table>	EZ	DC	CM558081	CM558087	⤴ 30 → 150 mm ⤵ 50 → 600 mm KITASSTR CE25+CE30+BTRCC 6 x 20 Kits comprise large clamp plate, small clamp plate, M6 nut and M6 x 20 coach bolt
EZ	DC					
CM558081	CM558087					
50	<table border="1"> <tr> <td>EZ</td> <td>DC</td> </tr> <tr> <td>CM558071</td> <td>CM558077</td> </tr> </table>	EZ	DC	CM558071	CM558077	KITASSVS CE25VS+CE30ES Kits comprise large clamp plate with integrated bolt and small clamp plate with integrated bolt
EZ	DC					
CM558071	CM558077					
50	<table border="1"> <tr> <td>EZ</td> <td>DC</td> </tr> <tr> <td>CM558091</td> <td>-</td> </tr> </table>	EZ	DC	CM558091	-	KITFIXTR CE25+BTRCC 6 X 20 Kits comprise small clamp plate, M6 nut and M6 x 20 coach bolt
EZ	DC					
CM558091	-					
50	<table border="1"> <tr> <td>EZ</td> <td>DC</td> </tr> <tr> <td>CM558061</td> <td>-</td> </tr> </table>	EZ	DC	CM558061	-	KITFIXVS CE25VS+EEC6 Kits comprise small clamp plate with M6 nut and integrated bolt
EZ	DC					
CM558061	-					

Pack	Cat. Nos.	KITS – stainless steel fixing kits				
50	<table border="1"> <tr> <td>304L</td> <td>316L</td> </tr> <tr> <td>-</td> <td>CM558954</td> </tr> </table>	304L	316L	-	CM558954	⤴ 30 → 150 mm ⤵ 50 → 600 mm KITINOX stainless steel CE25VS+CE30+EEC6 Kits comprise large clamp plate, small clamp plate with integrated bolt and M6 nut
304L	316L					
-	CM558954					
100	<table border="1"> <tr> <td>304L</td> <td>316L</td> </tr> <tr> <td>-</td> <td>CM558084</td> </tr> </table>	304L	316L	-	CM558084	KITASSTR stainless steel CE25+CE30+BTRCC 6 x 20 Kits comprise large clamp plate, small clamp plate, M6 nut and M6 x 20 coach bolt
304L	316L					
-	CM558084					

Key :	EZ Electrogalvanising after manufacture	304L Stainless steel 304L
	GC Hot dip galvanised after manufacture	316L Stainless steel 316L
	DC Geomet	For detailed information related to finishes, refer to p. 116-117

All dimensions (mm) are nominal

wall mounting – UC50 - CAT30 - CAT40 - CM50 - CM50XL

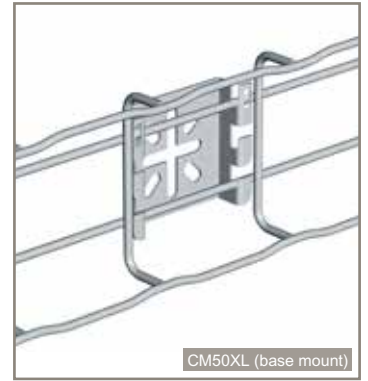
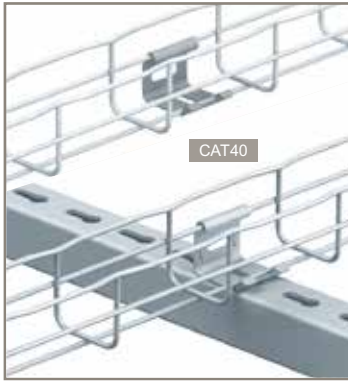
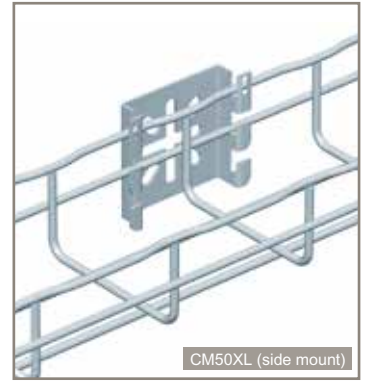
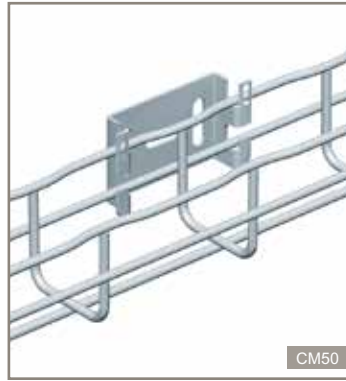
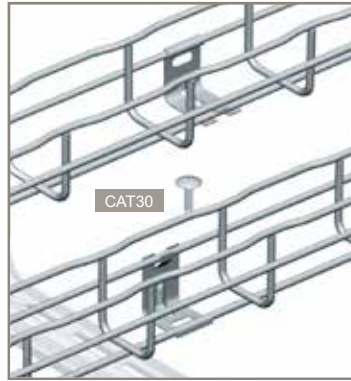

Dimensions and technical information p. 52-55

NOTE : please use Cat. No. when placing your order

Pack	Cat. Nos.	UC50 – support cradles						
		$\updownarrow 30 \rightarrow 54 \text{ mm}$ $\leftrightarrow 50 \text{ mm}$ For technical information, see p. 52 						
1	<table border="0"> <tr> <td> GS</td> <td> GC</td> </tr> <tr> <td>CM586040</td> <td>CM586043</td> </tr> <tr> <td> 304L</td> <td> 316L</td> </tr> </table>	GS	GC	CM586040	CM586043	304L	316L	12
GS	GC							
CM586040	CM586043							
304L	316L							
1	<table border="0"> <tr> <td> 304L</td> <td> 316L</td> </tr> <tr> <td>CM586048</td> <td>CM586044</td> </tr> </table>	304L	316L	CM586048	CM586044	12		
304L	316L							
CM586048	CM586044							

NOTE : please use Cat. No. when placing your order

Pack	Cat. Nos.	CM50 – universal mounting plates (small)						
		$\updownarrow 54 \text{ mm}$ $\leftrightarrow 50 \text{ mm}$ For technical information, see p. 55 						
1	<table border="0"> <tr> <td> GS</td> <td> GC</td> </tr> <tr> <td>CM586060</td> <td>CM586063</td> </tr> <tr> <td> 304L</td> <td> 316L</td> </tr> </table>	GS	GC	CM586060	CM586063	304L	316L	
GS	GC							
CM586060	CM586063							
304L	316L							
1	<table border="0"> <tr> <td> 304L</td> <td> 316L</td> </tr> <tr> <td>CM586068</td> <td>CM586064</td> </tr> </table>	304L	316L	CM586068	CM586064			
304L	316L							
CM586068	CM586064							

Pack	Cat. Nos.	CAT30 – cantilever arm fixing plates						
		$\updownarrow 30 \rightarrow 54 \text{ mm}$ $\leftrightarrow 50 \text{ mm}$ For technical information, see p. 53 						
1	<table border="0"> <tr> <td> GS</td> <td> DC</td> </tr> <tr> <td>CM586050</td> <td>CM586057</td> </tr> <tr> <td> 304L</td> <td> 316L</td> </tr> </table>	GS	DC	CM586050	CM586057	304L	316L	20
GS	DC							
CM586050	CM586057							
304L	316L							
1	<table border="0"> <tr> <td> 304L</td> <td> 316L</td> </tr> <tr> <td>CM586058</td> <td>CM586054</td> </tr> </table>	304L	316L	CM586058	CM586054	20		
304L	316L							
CM586058	CM586054							

Pack	Cat. Nos.	CM50XL – universal mounting plates (large)						
		$\updownarrow 54 \rightarrow 80 \text{ mm}$ $\leftrightarrow 50 \rightarrow 100 \text{ mm}$ (side wire mounting) $\updownarrow 30 \rightarrow 105 \text{ mm}$ $\leftrightarrow 100 \rightarrow 600 \text{ mm}$ (base wire mounting) For technical information, see p. 55 						
1	<table border="0"> <tr> <td> GS</td> <td> GC</td> </tr> <tr> <td>CM586130</td> <td>CM586133</td> </tr> <tr> <td> 304L</td> <td> 316L</td> </tr> </table>	GS	GC	CM586130	CM586133	304L	316L	
GS	GC							
CM586130	CM586133							
304L	316L							
1	<table border="0"> <tr> <td> 304L</td> <td> 316L</td> </tr> <tr> <td>CM586138</td> <td>CM586134</td> </tr> </table>	304L	316L	CM586138	CM586134			
304L	316L							
CM586138	CM586134							

Pack	Cat. Nos.	CAT40 – channel fixing plates						
		$\updownarrow 30 \rightarrow 54 \text{ mm}$ $\leftrightarrow 50 \text{ mm}$ For technical information, see p. 54 						
1	<table border="0"> <tr> <td> GS</td> <td> DC</td> </tr> <tr> <td>CM586190</td> <td>CM586197</td> </tr> <tr> <td> 304L</td> <td> 316L</td> </tr> </table>	GS	DC	CM586190	CM586197	304L	316L	20
GS	DC							
CM586190	CM586197							
304L	316L							
1	<table border="0"> <tr> <td> 304L</td> <td> 316L</td> </tr> <tr> <td>-</td> <td>CM586194</td> </tr> </table>	304L	316L	-	CM586194	20		
304L	316L							
-	CM586194							

Key :

Pre-galvanised	Stainless steel 304L
Hot dip galvanised after manufacture	Stainless steel 316L
Geomet	

For detailed information related to finishes, refer to p. 116-117

All dimensions (mm) are nominal

wall mounting – CSN - CSNC

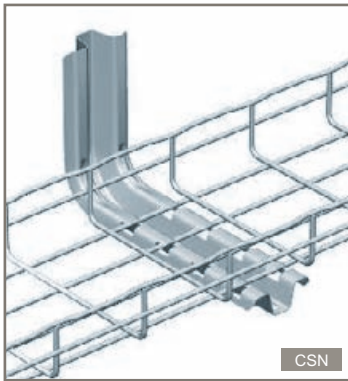

CSN

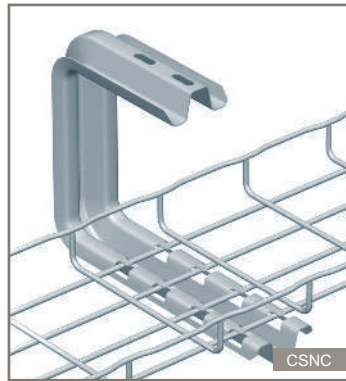

CSNC

Dimensions and technical information p. 56-57

NOTE : please use Cat. No. when placing your order

Pack	Cat. Nos.		CSN – profile cantilever arms		
			\downarrow 30 → 54 mm	\leftarrow 100 → 450 mm	For technical information, see p. 56
	GS	GC	L	\downarrow F	
			mm	daN	
1	CM556100	CM556103	CSN100	178	30
1	CM556110	CM556113	CSN150	228	110
1	CM556120	CM556123	CSN200	278	85
1	CM556130	CM556133	CSN300	378	73
1	CM556140	CM556143	CSN400	478	56
1	CM556150	CM556153	CSN450	528	50
	304L	316L			
1	CM556108	CM556104	CSN100	178	30
1	CM556118	CM556114	CSN150	228	110
1	CM556128	CM556124	CSN200	278	85
1	CM556138	CM556134	CSN300	378	73

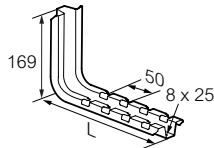

NOTE : please use Cat. No. when placing your order

Pack	Cat. Nos.		CSNC – profile roof cantilever arms			
			\downarrow 30 → 54 mm	\leftarrow 100 → 450 mm	For technical information, see p. 57	
	GS	GC	L1	L2	\downarrow F	
			mm	mm	daN	
1	CM556300	CM556303	CSNC100	170	178	120
1	CM556310	CM556313	CSNC150	170	228	100
1	CM556320	CM556323	CSNC200	170	278	80
1	CM556330	CM556333	CSNC300	288	378	70
1	CM556340	CM556343	CSNC400	288	478	48
1	CM556350	CM556353	CSNC450	288	528	44
	304L	316L				
1	-	CM556304	CSNC100	170	178	120
1	-	CM556314	CSNC150	170	228	100
1	-	CM556324	CSNC200	170	278	80

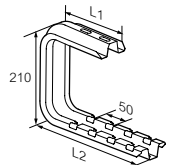

EPVCSN – end caps

Pack	Cat. Nos.	
1	PVC CM559605	For use with CSN and CSNC cantilever arms



Key :	GS Pre-galvanised	304L Stainless steel 304L
	GC Hot dip galvanised after manufacture	316L Stainless steel 316L

For detailed information related to finishes, refer to p. 116-117

All dimensions (mm) are nominal

wall mounting – CB - CU



Dimensions and technical information **p. 58-61**

NOTE : please use Cat. No. when placing your order

Pack	Cat. Nos.		
	NEW		
	GS	GC	316L
1	CM350800	CM350803	CM350804
1	CM350810	CM350813	CM350814
1	CM350820	CM350823	CM350824
1	CM350830	CM350833	CM350834
1	CM350840	CM350843	CM350844
1	CM350850	CM350853	CM350854

CB – compact cantilever arms for universal mounting

⬇️ 30 → 150 mm ⬅️ 50 → 400 mm

For technical information, including safe working load, see p. 58-59

	L mm	H mm	For tray widths mm
CB50	81	71	50
CB100	131	71	100
CB150	181	75	150
CB200/ 250	231	75	200/ 250
CB300	335	88	300
CB400	435	102	400

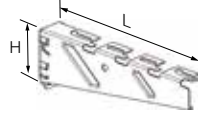

NOTE : please use Cat. No. when placing your order

Pack	Cat. Nos.		
	GS	GC	316L
1	CM557460	CM557463	CM557464
1	CM557470	CM557473	CM557474

CU – cantilever arms for universal mounting

⬇️ 30 → 150 mm ⬅️ 500 → 600 mm

For technical information, see p. 60-61

	L mm	H mm	daN	daN	For tray widths mm
CU500	557	138	220	160	500
CU600	657	138	200	145	600

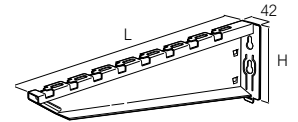

Key :

GS Pre-galvanised	316L Stainless steel 316L
GC Hot dip galvanised after manufacture	

For detailed information related to finishes, refer to **p. 116-117**

All dimensions (mm) are nominal

wall mounting – CLN - CC21S - R15/25/35 - R55 - FV1

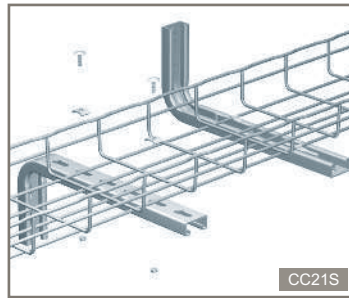
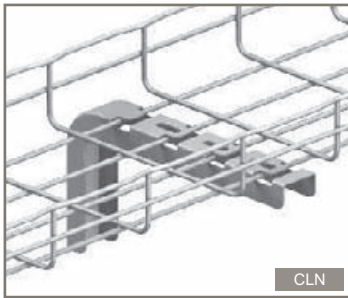

Dimensions and technical information p. 62-64

NOTE : please use Cat. No. when placing your order

Pack	Cat. Nos.		CLN – cantilever arms			
			$\downarrow \uparrow 30 \rightarrow 54 \text{ mm}$	$\leftarrow \rightarrow 100 \rightarrow 300 \text{ mm}$	For technical information, see p. 62	
	GS	GC	L	H	$\downarrow F$	
	mm	mm	mm	mm	daN	
1	CM556200	CM556203	CLN100	100	125	95
1	CM556210	CM556213	CLN150	150	125	70
1	CM556220	CM556223	CLN200	200	125	40
1	CM556230	CM556233	CLN300	300	125	25

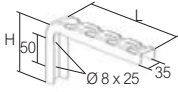

Pack	Cat. Nos.		CC21S – cantilever arms			
			$\downarrow \uparrow 30 \rightarrow 105 \text{ mm}$	$\leftarrow \rightarrow 100 \rightarrow 400 \text{ mm}$	For technical information, see p. 62	
	GS	316L	L	$\downarrow F$		
	mm	mm	mm	daN		
1	CM557860	CM557864	CC21S 150	150	135	
1	CM557870	CM557874	CC21S 200	200	108	
1	CM557880	CM557884	CC21S 300	300	80	
1	CM557890	CM557894	CC21S 400	400	92	

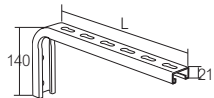

NOTE : please use Cat. No. when placing your order

Pack	Cat. Nos.			R15 / R25 / R35 – stand-off brackets		
				$\downarrow \uparrow 30 \rightarrow 105 \text{ mm}$	$\leftarrow \rightarrow 100 \rightarrow 600 \text{ mm}$	For technical information, see p. 63
	GS	Z+	316L	H	$\downarrow F$	
	mm	mm	mm	daN		
1	CM586170	CM586173	CM586174	R15/100	15	100
1	CM586610	CM586617	-	R15/300	15	100
1	CM586640	CM586647	-	R25	25	100
1	CM586650	CM586657	-	R35	35	50

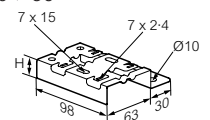

Pack	Cat. Nos.			R55 – stand-off brackets		
				$\downarrow \uparrow 30 \rightarrow 105 \text{ mm}$	$\leftarrow \rightarrow 100 \rightarrow 600 \text{ mm}$	For technical information, see p. 63
	GS	Z+	316L	H	$\downarrow F$	
	mm	mm	mm	daN		
1	CM586080	CM586083	CM586084	55	45	

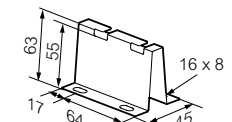

Pack	Cat. Nos.			FV1 – mounting brackets		
				$\downarrow \uparrow 30 \rightarrow 105 \text{ mm}$	$\leftarrow \rightarrow 100 \rightarrow 600 \text{ mm}$	For technical information, see p. 64
	GS	DC	316L	$\downarrow F$		
	mm	mm	mm	daN		
1	CM586070	CM586073	CM586074	100		

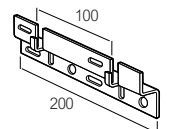

Key :	GS Pre-galvanised	316L Stainless steel 316L
	GC Hot dip galvanised after manufacture	DC Geomet
	Z+ Continuous galvanisation before manufacture	For detailed information related to finishes, refer to p. 116-117

All dimensions (mm) are nominal

wall mounting – RCSN - EDF - RE41SP - INTERFAS - CA



RCSN – wall mounting – vertical



RCSN – wall mounting – horizontal

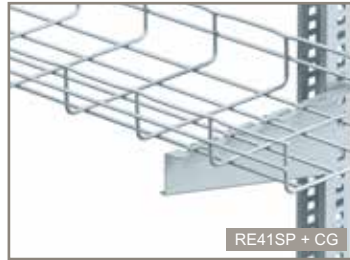

RE41SP + CG



INTERFAS + CSN, see p. 21



CG + EDF

Dimensions and technical information p. 56, 58-61, 65

NOTE : please use Cat. No. when placing your order

Pack	Cat. Nos.		RCSN – fast fix support rails		
			$\downarrow \uparrow 30 \rightarrow 105 \text{ mm}$	$\leftarrow \rightarrow 100 \rightarrow 600 \text{ mm}$	For technical information, see p. 65
	GS	GC	L	F	
			mm	daN	
1	CM013150	CM013153	RCSN150	150	100
1	CM013200	CM013203	RCSN200	200	100
1	CM013300	CM013303	RCSN300	300	100
1	CM013400	CM013403	RCSN400	400	100
1	CM013500	CM013503	RCSN500	500	100
1	CM013550	CM013553	RCSN550	550	100
1	CM013600	CM013603	RCSN600	600	100
1	CM013010	CM013013	RCSN1000	1000	100
1	CM013020	CM013023	RCSN2000	2000	100
1	CM013030	CM013033	RCSN3000	3000	100
	304L	316L			
1	–	CM013154	RCSN150	150	100
1	–	CM013204	RCSN200	200	100
1	–	CM013304	RCSN300	300	100
1	–	CM013404	RCSN400	400	100
1	–	CM013504	RCSN500	500	100
1	–	–	RCSN550	550	100
1	–	CM013604	RCSN600	600	100
1	–	CM013014	RCSN1000	1000	100
1	CM013028	CM013024	RCSN2000	2000	100
1	CM013038	CM013034	RCSN3000	3000	100

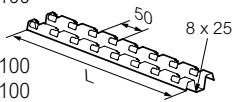

Pack	Cat. Nos.		RE41SP – pendants / mounting rails (heavy duty)		
			$\downarrow \uparrow 30 \rightarrow 150 \text{ mm}$	$\leftarrow \rightarrow 100 \rightarrow 600 \text{ mm}$	For technical information, see p. 60-61
	GS		L		
			mm	mm	
1	CM595750	RE41SP500	500	2	
1	CM595780	RE41SP800	800	2	
1	CM595790	RE41SP1000	1000	2	
1	CM595700	RE41SP3000	3000	2	

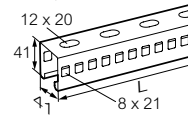

Pack	Cat. Nos.			INTERFAS – adaptor plates		
						Used for connecting CSN profile cantilever arms to channel length. For technical information, see p. 56
	GS	DC	316L			
1	CM557800	CM557803	–			

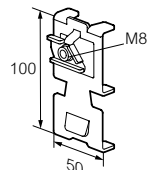

Pack	Cat. Nos.		EDF – pendants / mounting rails		
			$\downarrow \uparrow 30 \rightarrow 150 \text{ mm}$	$\leftarrow \rightarrow 100 \rightarrow 600 \text{ mm}$	For technical information, see p. 60-61
	GS	GC	L		
			mm		
1	CM557610	CM557613	EDF600	600	
1	CM561090	CM561093	EDF1000	1000	
1	CM561010	CM561013	EDF2000	2000	
1	CM561020	CM561023	EDF3000	3000	
	304L	316L			
1	CM561018	CM561014	EDF2000	2000	

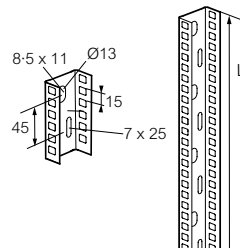

Key :	EZ Electrogalvanising after manufacture	304L Stainless steel 304L
	GS Pre-galvanised	316L Stainless steel 316L
	GC Hot dip galvanised after manufacture	
	DC Geomet	

For detailed information related to finishes, refer to p. 116-117

All dimensions (mm) are nominal

ceiling mounting – SF50 - SF100 - SL50 - CEQ - UC50 - SAS - CE40 - CM50XL

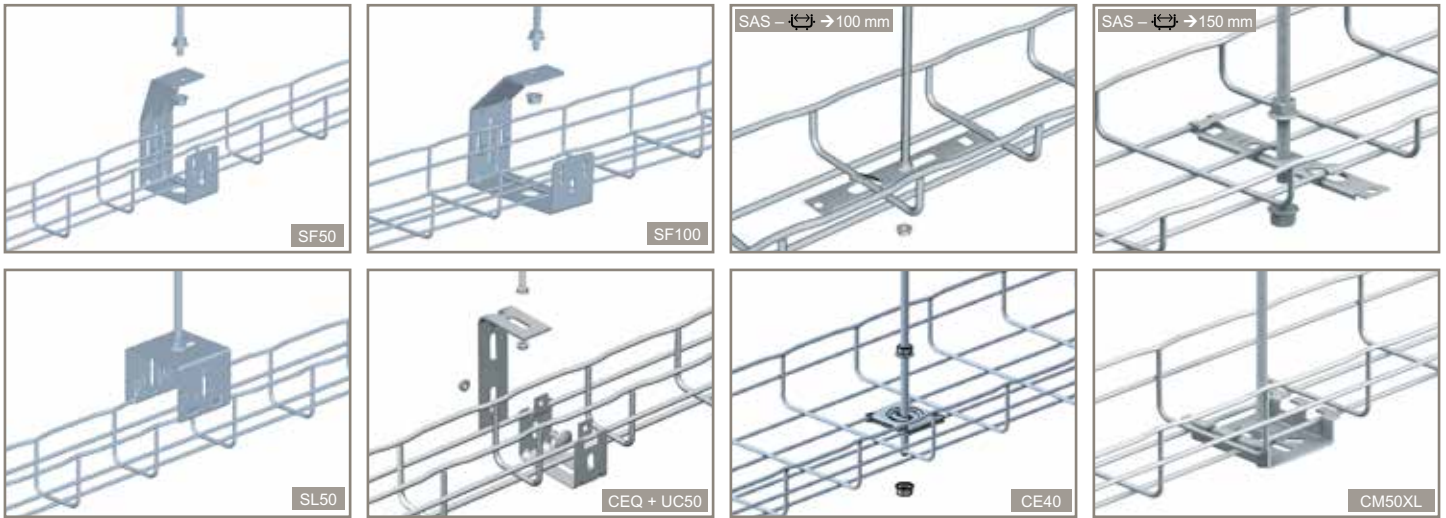

Dimensions and technical information p. 66-69

NOTE : please use Cat. No. when placing your order

Pack	Cat. Nos.		SF50 - SF100 – central hangers		
	GS	GC	$\updownarrow 30 \rightarrow 54$ mm $\curvearrowright 50 \rightarrow 100$ mm		
			For technical information, see p. 66		
1	CM586140	CM586143	SF50	30	73
1	CM586100	CM586103	SF100	26	134
	304L	316L			
1	-	CM586144	SF50	30	73
1	-	CM586104	SF100	26	134

Pack	Cat. Nos.	SL50 – multifix base plate			
	GS	$\updownarrow 30 \rightarrow 54$ mm $\curvearrowright 50$ mm			
			For technical information, see p. 66		
1	CM585180	H	\downarrow	$\varnothing 7 \times 25$	
		mm	daN		
		56	150		

Pack	Cat. Nos.		CEQ – central hanger brackets		
	GS	GC	$\updownarrow 30 \rightarrow 54$ mm $\curvearrowright 50$ mm		
			For technical information, see p. 67		
1	CM557300	CM557303	\downarrow		
	304L	316L	daN		
1	-	CM557304	12		

Pack	Cat. Nos.		UC50 – support cradles		
	GS	GC	$\updownarrow 30 \rightarrow 54$ mm $\curvearrowright 50$ mm		
			For technical information, see p. 67		
1	CM586040	CM586043	\downarrow		
	304L	316L	daN		
1	CM586048	CM586044	12		

NOTE : please use Cat. No. when placing your order

Pack	Cat. Nos.		SAS – suspension hangers		
	EZ	DC	$\updownarrow 30 \rightarrow 54$ mm $\curvearrowright 100 \rightarrow 150$ mm		
			For technical information, see p. 68		
1	CM586031	CM586037	\downarrow		
			daN		
			60		

Pack	Cat. Nos.		CE40 – hold down clamps		
	EZ	DC	$\updownarrow 30 \rightarrow 54$ mm $\curvearrowright 100 \rightarrow 200$ mm		
			For technical information, see p. 69		
25	CM558051	CM558053	\downarrow		
	304L	316L	daN		
25	CM558058	CM558054	100		

Pack	Cat. Nos.		CM50XL – universal mounting plates (large)		
	GS	GC	$\updownarrow 30 \rightarrow 54$ mm $\curvearrowright 100 \rightarrow 200$ mm		
			For technical information, see p. 69		
1	CM586130	CM586133	100		
	304L	316L	\downarrow		
1	CM586138	CM586134	daN		
			100		

Key :	EZ Electrogalvanising after manufacture	304L Stainless steel 304L
	GS Pre-galvanised	316L Stainless steel 316L
	GC Hot dip galvanised after manufacture	
	DC Geomet	

For detailed information related to finishes, refer to p. 116-117

All dimensions (mm) are nominal

ceiling mounting – RCSN - EDF - PFREDF - RE41SP - PFR41S

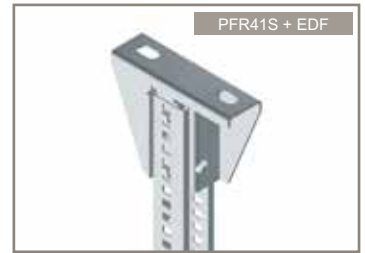
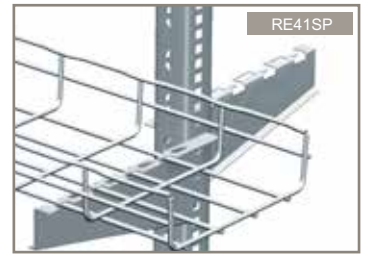
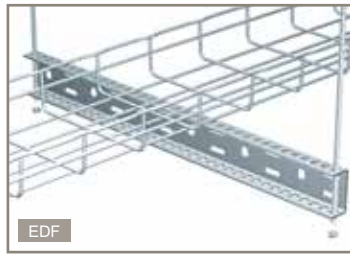

Dimensions and technical information p. 71, 74-77

NOTE : please use Cat. No. when placing your order

Pack	Cat. Nos.		RCSN – fast fix support rails	
			$\downarrow \uparrow 30 \rightarrow 105 \text{ mm}$	$\leftarrow \rightarrow 100 \rightarrow 600 \text{ mm}$
			For trapeze mounting, add 100 mm to width of tray to order correct size support rail - e.g. for 100 mm tray order RCSN200 (Cat. Nos. CM013200 / 03 / 04) For technical information, see p. 71, 74	
	GS	GC		L mm
1	CM013150	CM013153	RCSN150	150
1	CM013200	CM013203	RCSN200	200
1	CM013300	CM013303	RCSN300	300
1	CM013400	CM013403	RCSN400	400
1	CM013500	CM013503	RCSN500	500
1	CM013550	CM013553	RCSN550	550
1	CM013600	CM013603	RCSN600	600
1	CM013010	CM013013	RCSN1000	1000
1	CM013020	CM013023	RCSN2000	2000
1	CM013030	CM013033	RCSN3000	3000
	304L	316L		
1	-	CM013154	RCSN150	150
1	-	CM013204	RCSN200	200
1	-	CM013304	RCSN300	300
1	-	CM013404	RCSN400	400
1	-	CM013504	RCSN500	500
1	-	-	RCSN550	550
1	-	CM013604	RCSN600	600
1	-	CM013014	RCSN1000	1000
1	CM013028	CM013024	RCSN2000	2000
1	CM013038	CM013034	RCSN3000	3000

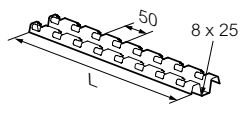

NOTE : please use Cat. No. when placing your order

Pack	Cat. Nos.		PFREDF – pendant mounting plates	
			$\downarrow \uparrow 30 \rightarrow 105 \text{ mm}$	$\leftarrow \rightarrow 100 \rightarrow 600 \text{ mm}$
			For technical information see p. 76	
	GS	GC		daN.m
1	CM561080	-		18
	304L	316L		
1	-	CM561084		18

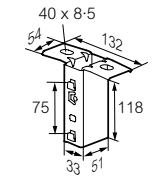

Pack	Cat. Nos.		RE41SP – pendants / mounting rails (heavy duty)	
			$\downarrow \uparrow 30 \rightarrow 105 \text{ mm}$	$\leftarrow \rightarrow 100 \rightarrow 600 \text{ mm}$
			For technical information see p. 77	
	GS			L mm
1	CM595750	RE41SP500	500	2
1	CM595780	RE41SP800	800	2
1	CM595790	RE41SP1000	1000	2
1	CM595700	RE41SP3000	3000	2

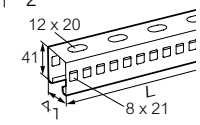

Pack	Cat. Nos.		EDF – profile pendants / mounting rails	
			$\downarrow \uparrow 30 \rightarrow 105 \text{ mm}$	$\leftarrow \rightarrow 100 \rightarrow 600 \text{ mm}$
			For technical information see p. 75-76	
	GS	GC		L mm
1	CM561010	CM561013	EDF2000	2000
	304L	316L		
1	CM561018	CM561014	EDF2000	2000

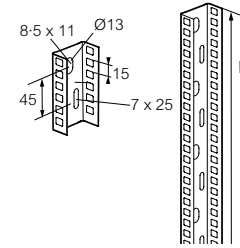

Pack	Cat. Nos.		PFR41S – pendant mounting plate (heavy duty)	
			$\downarrow \uparrow 30 \rightarrow 105 \text{ mm}$	$\leftarrow \rightarrow 100 \rightarrow 600 \text{ mm}$
			For technical information see p. 77	
	GS			daN
1	CM595380			45

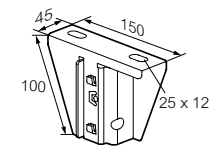

Key :

- GS** Pre-galvanised
- 304L** Stainless steel 304L
- GC** Hot dip galvanised after manufacture
- 316L** Stainless steel 316L

For detailed information related to finishes, refer to **p. 116-117**

All dimensions (mm) are nominal

floor mounting – CM50XL - RCSN - R15/25/35 - R55

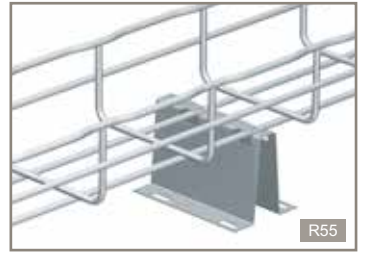
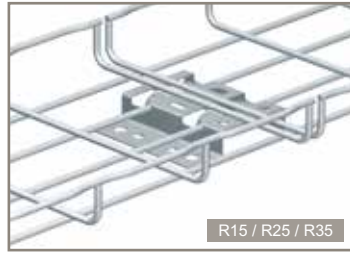
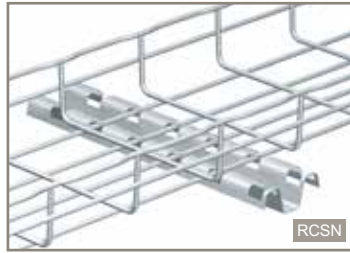
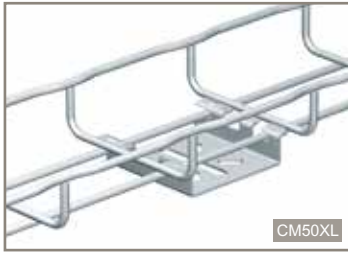

Dimensions and technical information **p. 78-79, 82-83**

NOTE : please use Cat. No. when placing your order

Pack	Cat. Nos.		CM50XL – universal mounting plates (large)	
			$\downarrow \uparrow$ 30 → 150 mm \curvearrowright 100 → 600 mm For technical information, see p. 78	
1	CM586130	CM586133		
1	CM586138	CM586134		

NOTE : please use Cat. No. when placing your order

Pack	Cat. Nos.			R15 / R25 / R35 – stand-off brackets	
				$\downarrow \uparrow$ 30 → 105 mm \curvearrowright 100 → 600 mm For technical information, see p. 79	
1	CM586170	CM586173	CM586174	R15/100	15
1	CM586610	CM586617	-	R15/300	15
1	CM586640	CM586647	-	R25	25
1	CM586650	CM586657	-	R35	35

		RCSN – fast fix support rails		
		$\downarrow \uparrow$ 30 → 150 mm \curvearrowright 100 → 600 mm For technical information, see p. 78, 82-83		
				L mm
1	CM013150	CM013153	RCSN150	150
1	CM013200	CM013203	RCSN200	200
1	CM013300	CM013303	RCSN300	300
1	CM013400	CM013403	RCSN400	400
1	CM013500	CM013503	RCSN500	500
1	CM013550	CM013553	RCSN550	550
1	CM013600	CM013603	RCSN600	600
1	CM013010	CM013013	RCSN1000	1000
1	CM013020	CM013023	RCSN2000	2000
1	CM013030	CM013033	RCSN3000	3000
1	-	CM013154	RCSN150	150
1	-	CM013204	RCSN200	200
1	-	CM013304	RCSN300	300
1	-	CM013404	RCSN400	400
1	-	CM013504	RCSN500	500
1	-	-	RCSN550	550
1	-	CM013604	RCSN600	600
1	-	CM013014	RCSN1000	1000
1	CM013028	CM013024	RCSN2000	2000
1	CM013038	CM013034	RCSN3000	3000

		R55 – stand-off brackets			
		$\downarrow \uparrow$ 30 → 150 mm \curvearrowright 100 → 600 mm For technical information, see p. 79			
				H mm	
1	CM586080	CM586083	CM586084	55	

Key :	Pre-galvanised	Stainless steel 304L
	Hot dip galvanised after manufacture	Stainless steel 316L
	Continuous galvanisation before manufacture	For detailed information related to finishes, refer to p. 116-117

All dimensions (mm) are nominal

floor mounting – FTX – UC50 – UFC

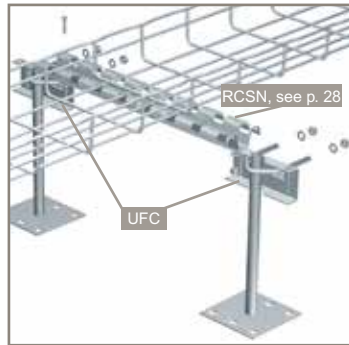
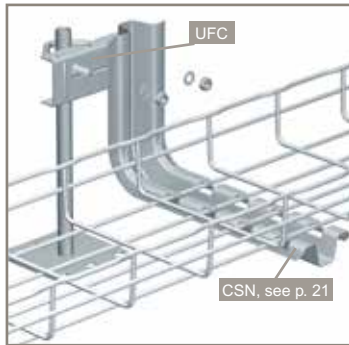
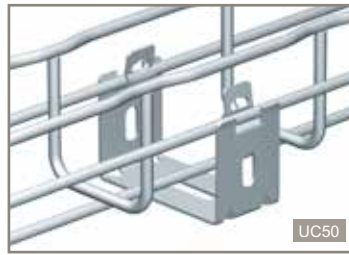

beam mounting - CLMFAS – CLMU – EF

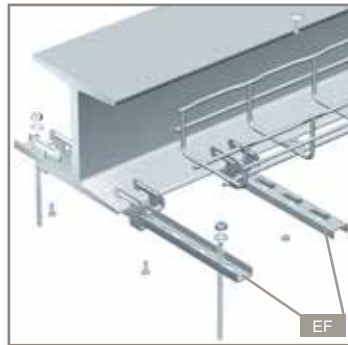
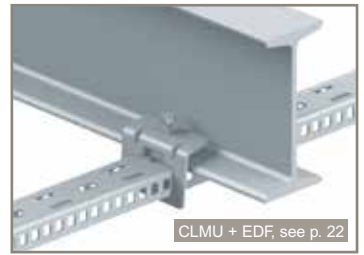

Dimensions and technical information **p. 80-85**

NOTE : please use Cat. No. when placing your order

Pack	Cat. Nos.	FTX – base fixing plates						
1	<table border="1"> <tr> <td>GS</td> <td>DC</td> <td>316L</td> </tr> <tr> <td>CM586180</td> <td>CM586183</td> <td>CM586184</td> </tr> </table>	GS	DC	316L	CM586180	CM586183	CM586184	<p>⏏ 30 / 54 / 105 mm ⏏ 35 → 600 mm</p> <p>For technical information see p. 80</p>
GS	DC	316L						
CM586180	CM586183	CM586184						

Pack	Cat. Nos.	UC50 – support cradles				
1	<table border="1"> <tr> <td>GS</td> <td>GC</td> </tr> <tr> <td>CM586040</td> <td>CM586043</td> </tr> </table>	GS	GC	CM586040	CM586043	<p>⏏ 30 → 54 mm ⏏ 50 mm</p> <p>For technical information see p. 80</p>
GS	GC					
CM586040	CM586043					
1	<table border="1"> <tr> <td>304L</td> <td>316L</td> </tr> <tr> <td>CM586048</td> <td>CM586044</td> </tr> </table>	304L	316L	CM586048	CM586044	<p>⏏ 12</p>
304L	316L					
CM586048	CM586044					

Pack	Cat. Nos.	UFC – clamp unit		
1	<table border="1"> <tr> <td>GS</td> </tr> <tr> <td>CM559220</td> </tr> </table>	GS	CM559220	<p>⏏ 30 → 105 mm ⏏ 100 → 600 mm</p> <p>For technical information see p. 81-82</p>
GS				
CM559220				

Dimensions and technical information **p. 83-85**

NOTE : please use Cat. No. when placing your order

Pack	Cat. Nos.	Beam clamps															
1	<table border="1"> <tr> <td>GS</td> <td>Z+</td> <td>316L</td> </tr> <tr> <td>CM559280</td> <td>CM559287</td> <td>CM559284</td> </tr> </table>	GS	Z+	316L	CM559280	CM559287	CM559284	<p>CLMFAS – beam clamps</p> <p>⏏ 30 → 105 mm ⏏ 50 → 600 mm</p> <p>For technical information see p. 83</p> <p>⏏ daN.m</p> <p>18</p>									
GS	Z+	316L															
CM559280	CM559287	CM559284															
1	<table border="1"> <tr> <td>GS</td> <td>Z+</td> <td>316L</td> </tr> <tr> <td>CM559090</td> <td>CM559097</td> <td>–</td> </tr> </table>	GS	Z+	316L	CM559090	CM559097	–	<p>CLMU – beam clamps</p> <p>⏏ 30 → 105 mm ⏏ 50 → 600 mm</p> <p>For technical information see p. 84</p> <p>⏏ daN.m</p> <p>15</p>									
GS	Z+	316L															
CM559090	CM559097	–															
1	<table border="1"> <tr> <td>EZ</td> </tr> <tr> <td>CM559201</td> </tr> <tr> <td>CM559211</td> </tr> </table>	EZ	CM559201	CM559211	<p>EF – adjustable beam clamps</p> <p>⏏ 30 → 54 mm ⏏ 100 → 300 mm</p> <p>For technical information see p. 85</p> <table border="1"> <thead> <tr> <th>L</th> <th>H</th> <th>⏏ daN.m</th> </tr> <tr> <th>mm</th> <th>mm</th> <th></th> </tr> </thead> <tbody> <tr> <td>400</td> <td>1→11</td> <td>3-5</td> </tr> <tr> <td>600</td> <td>1→15</td> <td>5-5</td> </tr> </tbody> </table>	L	H	⏏ daN.m	mm	mm		400	1→11	3-5	600	1→15	5-5
EZ																	
CM559201																	
CM559211																	
L	H	⏏ daN.m															
mm	mm																
400	1→11	3-5															
600	1→15	5-5															

Key :	
EZ	Electrogalvanising after manufacture
GS	Pre-galvanised
GC	Hot dip galvanised after manufacture
DC	Geomet
304L	Stainless steel 304L
316L	Stainless steel 316L
Z+	Continuous galvanisation before manufacture

For detailed information related to finishes, refer to **p. 116-117**

All dimensions (mm) are nominal

other mounting - take-off plates - SBDN – SBD – EXSBD

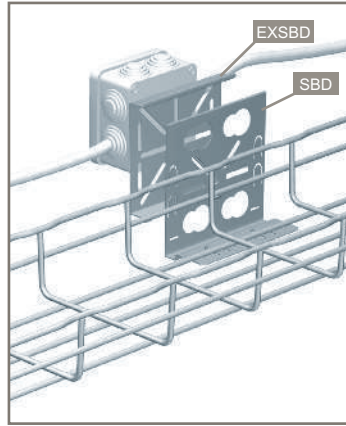
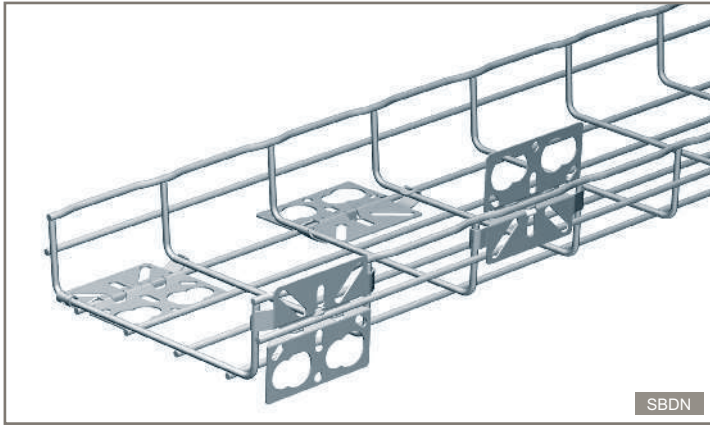

Dimensions and technical information p. 86

NOTE : please use Cat. No. when placing your order

Pack	Cat. Nos.	Take-off plates
1	<div style="display: flex; justify-content: space-around; align-items: center;"> <div style="text-align: center;"> <p>CM585410</p> </div> <div style="text-align: center;"> <p>CM585417</p> </div> </div>	<p>SBDN – universal conduit take-off plates ↳ 30 → 150 mm ↳ 50 → 600 mm For technical information see p. 86</p>

NOTE : please use Cat. No. when placing your order

Pack	Cat. Nos.	Take-off plates (continued)
1	<div style="display: flex; justify-content: space-around; align-items: center;"> <div style="text-align: center;"> <p>CM585110</p> </div> <div style="text-align: center;"> <p>CM585114</p> </div> </div>	<p>SBD – conduit take-off plate ↳ 30 → 150 mm ↳ 50 → 600 mm To be used with conduit take-off plate – EXSBD For technical information, see p. 86</p>
1	<div style="display: flex; justify-content: space-around; align-items: center;"> <div style="text-align: center;"> <p>CM585130</p> </div> <div style="text-align: center;"> <p>-</p> </div> </div>	<p>EXSBD – switch box take-off plate - side ↳ 30 → 150 mm ↳ 50 → 600 mm To be used with switch box take-off plate – SBD For technical information, see p. 86</p>

Key :	Pre-galvanised	Stainless steel 316L
	Continuous galvanisation before manufacture	For detailed information related to finishes, refer to p. 116-117

All dimensions (mm) are nominal

other mounting - universal mounting plates - CM50 – CM50XL – CAT40 – CM50XXL – CM50WL

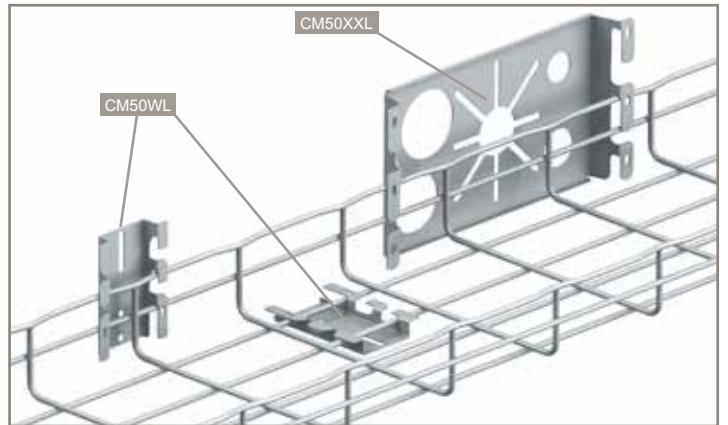
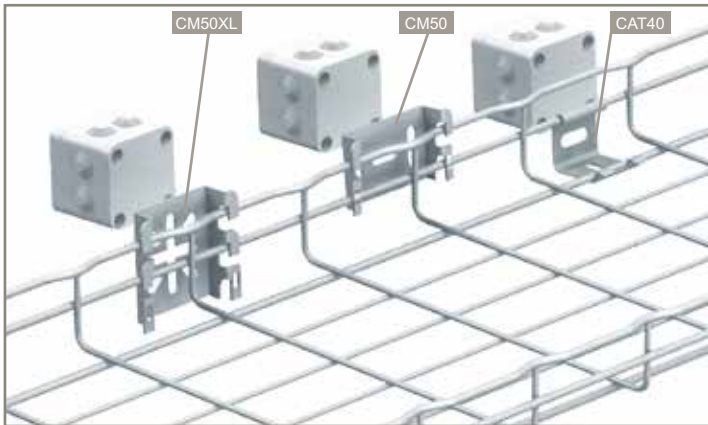

 Dimensions and technical information p. 87-88

NOTE : please use Cat. No. when placing your order

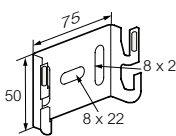
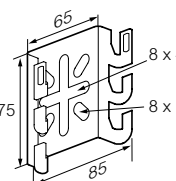
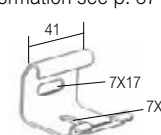
Pack	Cat. Nos.	Universal mounting plates								
1	<table border="0"> <tr> <td>GS</td> <td>GC</td> </tr> <tr> <td>CM586060</td> <td>CM586063</td> </tr> <tr> <td>304L</td> <td>316L</td> </tr> <tr> <td>CM586068</td> <td>CM586064</td> </tr> </table>	GS	GC	CM586060	CM586063	304L	316L	CM586068	CM586064	CM50 – universal mounting plates (small) ⤴ 30 / 54 / 105 mm ⤵ 50 → 600 mm For technical information see p. 87 
GS	GC									
CM586060	CM586063									
304L	316L									
CM586068	CM586064									
1	<table border="0"> <tr> <td>GS</td> <td>GC</td> </tr> <tr> <td>CM586130</td> <td>CM586133</td> </tr> <tr> <td>304L</td> <td>316L</td> </tr> <tr> <td>CM586138</td> <td>CM586134</td> </tr> </table>	GS	GC	CM586130	CM586133	304L	316L	CM586138	CM586134	CM50XL – universal mounting plates (large) ⤴ 30 / 54 / 105 mm ⤵ 50 → 600 mm For technical information see p. 87 
GS	GC									
CM586130	CM586133									
304L	316L									
CM586138	CM586134									
1	<table border="0"> <tr> <td>GS</td> <td>DC</td> <td>316L</td> </tr> <tr> <td>CM586190</td> <td>CM586197</td> <td>CM586194</td> </tr> </table>	GS	DC	316L	CM586190	CM586197	CM586194	CAT40 – universal mounting plates ⤴ 30 / 54 / 105 mm ⤵ 50 → 600 mm For technical information see p. 87 		
GS	DC	316L								
CM586190	CM586197	CM586194								

NOTE : please use Cat. No. when placing your order

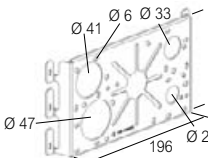
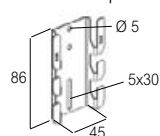
Pack	Cat. Nos.	Universal mounting plates (continued)				
1	<table border="0"> <tr> <td>GS</td> <td>DC</td> </tr> <tr> <td>CM586250</td> <td>CM586257</td> </tr> </table>	GS	DC	CM586250	CM586257	CM50XXL – universal mounting plates (extra large) ⤴ 30 → 105 ⤵ 50 → 600 mm For technical information see p. 88 
GS	DC					
CM586250	CM586257					
1	<table border="0"> <tr> <td>GS</td> <td>Z+</td> </tr> <tr> <td>CM586230</td> <td>CM586237</td> </tr> </table>	GS	Z+	CM586230	CM586237	CM50WL – universal Wieland mounting plates ⤴ 30 → 105 ⤵ 50 → 600 mm For technical information see p. 88 
GS	Z+					
CM586230	CM586237					

Key :	GS Pre-galvanised	DC Geomet
	GC Hot dip galvanised after manufacture	304L Stainless steel 304L
	Z+ Continuous galvanisation before manufacture	316L Stainless steel 316L
	For detailed information related to finishes, refer to p. 116-117	

All dimensions (mm) are nominal

other mounting - luminaire supports - SL50 – SL100 – MFM – MFPOLYA

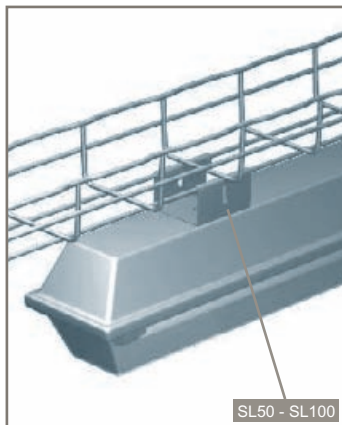

SL50 - SL100

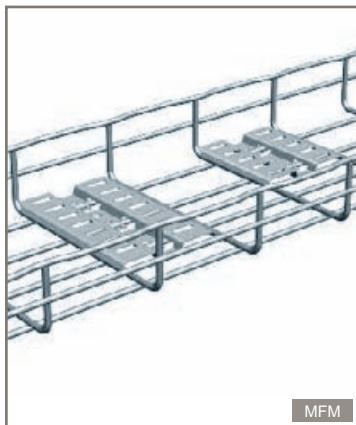



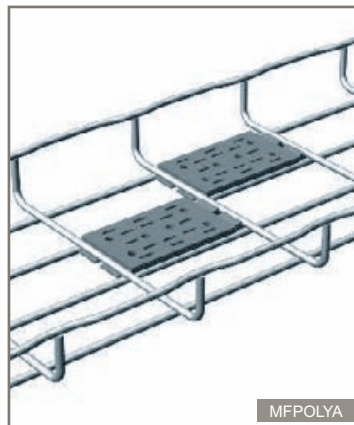







MFM

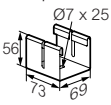

MFPOLYA

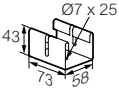

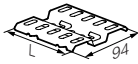
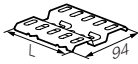

 Dimensions and technical information p. 89

NOTE : please use Cat. No. when placing your order

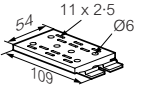
Pack	Cat. Nos.			Luminaire supports
1	 CM585180	 -	 -	SL50 – luminaire support ⤴ ⤵ 30 → 54 ⤴ ⤵ 50 mm For technical information see p. 89 H mm 56 F daN 150 
1	 CM585190	 -	 -	SL100 – luminaire support ⤴ ⤵ 30 → 105 ⤴ ⤵ 100 → 600 mm For technical information see p. 89 H mm 43 F daN 150 
1	 CM585140	 CM585143	 CM585144	MFM – multifix base plates ⤴ ⤵ 30 → 150 ⤴ ⤵ 100 → 600 mm For technical information see p. 89 L mm 100 
1	CM585150	CM585153	-	MFM150 L mm 150 

NOTE : please use Cat. No. when placing your order

Pack	Cat. Nos.	Luminaire supports (continued)
20	Polyamide CM585145	MFPOLYA – multifix base plate ⤴ ⤵ 30 → 150 ⤴ ⤵ 100 → 600 mm For technical information see p. 89 

Key :	 Pre-galvanised	 Stainless steel 316L
	 Hot dip galvanised after manufacture	
	 Continuous galvanisation before manufacture	For detailed information related to finishes, refer to p. 116-117

All dimensions (mm) are nominal

cabling accessories - FAS ROLLER – DEV100 – CABLOGRIP – CLIP – PA

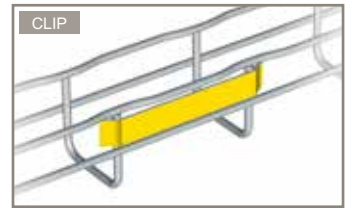
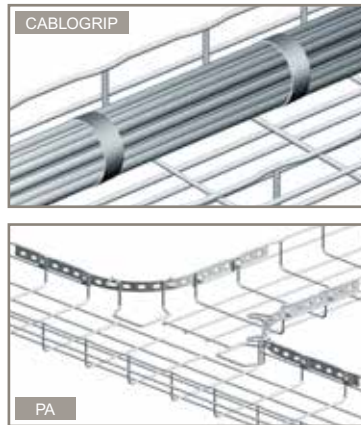
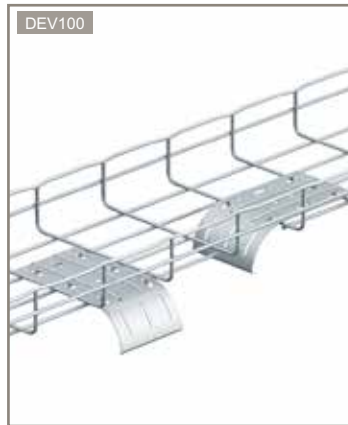

Dimensions and technical information **p. 90-92**

NOTE : please use Cat. No. when placing your order

Pack	Cat. Nos.	Cabling accessories			
1	<table border="1"> <tr> <td>GS</td> <td>GC</td> <td>316L</td> </tr> </table> CM011100 - -	GS	GC	316L	FAS ROLLER – cabling roller ⤴ 30 → 150 ⤵ 50 → 600 mm For technical information see p. 90
GS	GC	316L			
1	<table border="1"> <tr> <td>GS</td> <td>Z+</td> <td>316L</td> </tr> </table> CM585160 CM585167 CM585164	GS	Z+	316L	DEV100 – cable dropout plates ⤴ 30 → 150 ⤵ 100 → 600 mm For technical information see p. 90
GS	Z+	316L			
1	<table border="1"> <tr> <td>EZ</td> <td>GC</td> </tr> </table> CM559677	EZ	GC	CABLOGRIP – cable grip ⤴ 30 → 150 ⤵ 100 → 600 mm For technical information see p. 91 L mm 5 000 	
EZ	GC				

NOTE : please use Cat. No. when placing your order

Pack	Cat. Nos.	Cabling accessories (continued)		
50	PLAST CM559157	CLIP – identification tags ⤴ 30 → 150 ⤵ 50 → 600 mm For technical information see p. 91 CLIPJ CLIPV CLIPB CLIPO CLIPG CLIPP CLIPR CLIPW CLIPN		
50	CM559167			
50	CM559177			
50	CM559147			
50	CM559197			
50	CM559117			
50	CM559187			
50	CM559137			
50	CM559127			
50	CM559127			
1	<table border="1"> <tr> <td>EZ</td> <td>GC</td> </tr> </table> CM840101 CM840103 CM840111 CM840113 CM840131 CM840133	EZ	GC	PA – radius support ⤴ 30 / 54 / 105 ⤵ 50 → 600 mm For technical information see p. 92 H mm 30 PA1 54 PA2 105 PA4
EZ	GC			

Key :	EZ Electrogalvanising after manufacture	316L Stainless steel 316L
	GS Pre-galvanised	PLAST Plastic
	GC Hot dip galvanised after manufacture	
	Z+ Continuous galvanisation before manufacture	For detailed information related to finishes, refer to p. 116-117

All dimensions (mm) are nominal

earthing - BLF - GRIFEQUIP - GRIFEQUIP 2

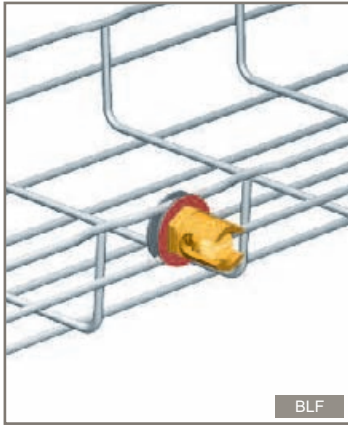

BLF

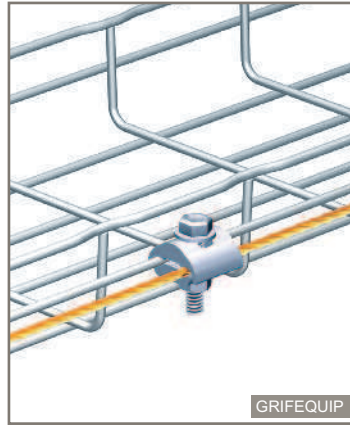

GRIFEQUIP

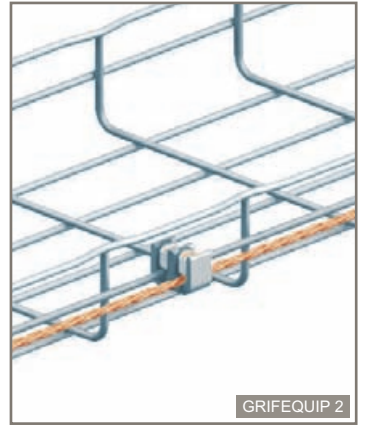

GRIFEQUIP 2

 Dimensions and technical information **p. 92-93**

NOTE : please use Cat. No. when placing your order

Pack	Cat. Nos.	Earth conductor clamps
		BLF – earth conductor clamp (copper)
		BLF 8/16 22 16
		BLF 8/35 24 35
		BLF 8/50 26 50
	CU	
1	CM585387	
1	CM585397	
1	CM585407	

BLF – earth conductor clamp (copper)

↕ 30 → 150 ↔ 50 → 600 mm

For technical information see p. 92

L mm | Ø mm²

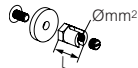

NOTE : please use Cat. No. when placing your order

Pack	Cat. Nos.	Earth conductor clamps
		GRIFEQUIP – earth conductor clamp (aluminium)
		GRIFEQUIP 2 – vertical clamp (aluminium)
		GRIFEQUIP – earth conductor clamp (aluminium)
		GRIFEQUIP 2 – vertical clamp (aluminium)
		GRIFEQUIP – earth conductor clamp (aluminium)
		GRIFEQUIP 2 – vertical clamp (aluminium)
	AL	
1	CM585327	
	AL	
1	CM585427	

GRIFEQUIP – earth conductor clamp (aluminium)

↕ 30/54/105 ↔ 50 → 600 mm

For technical information see p. 93





GRIFEQUIP 2 – vertical clamp (aluminium)

↕ 30/54/105 ↔ 50 → 600 mm

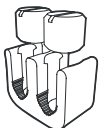
For technical information see p. 93



Key :  Aluminium  Copper

For detailed information related to finishes, refer to **p. 116-117**

All dimensions (mm) are nominal

fixings and fasteners + tools



BTRCC

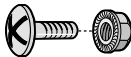

BTRL



EEC

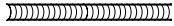

Threaded rods



Flat washers



Hexagon nuts



CUTYFIL

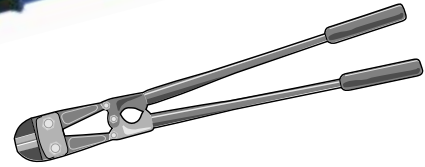

COUPEFILGM

NOTE : please use Cat. No. when placing your order

Pack	Cat. Nos.		Fixings and fasteners	
	EZ	DC	BTRCC	
100	CM801001	CM801007	BTRCC 6 x 12	Diameter 6 Ø
100	CM801011	CM801017	BTRCC 6 x 20	6 Ø
100	CM801021	CM801027	BTRCC 6 x 30	6 Ø
	304L	316L		
100	CM801008	CM801004	BTRCC 6 x 12	6 Ø
100	CM801018	CM801014	BTRCC 6 x 20	6 Ø
	EZ		BTRL	
100	CM801111		BTRL 8 x 15	Diameter 8 Ø
	EZ	316L	EEC – shouldered hexagon nuts	
100	CM801201	CM801204	EEC6	Diameter 6 Ø
100	CM801211	-	EEC8	8 Ø
			Threaded rod	
			Electroplated zinc	
			Size	
3 m	TR06		M6 x 3 m	
3 m	TR08		M8 x 3 m	
3 m	TR10		M10 x 3 m	
3 m	TR12		M12 x 3 m	
			Flat washers	
			Electroplated zinc	
			Size	
500	FW06		M6	
500	FW08		M8	
500	FW10		M10	
200	FW12		M12	
			Hexagon nuts	
			Electroplated zinc	
			Size	
500	HN06		M6	
500	HN08		M8	
200	HN10		M10	
200	HN12		M12	

NOTE : please use Cat. No. when placing your order

Pack	Cat. Nos.	Cutting tools
		CUTYFIL
1	CM559549	Electric wire tray cutter Supplied with rechargeable batteries
		COUPEFILGM – croppers
1	CM559507	Manual wire tray cutter Length : 630 mm
		Mounting tool
	EZ	CLEEDR
5	CM558260	For EDNR couplers, see p. 18

Key :

- EZ** Electrogalvanising after manufacture
- DC** Geomet
- 304L** Stainless steel 304L
- 316L** Stainless steel 316L

For detailed information related to finishes, refer to **p. 116-117**

All dimensions (mm) are nominal



technical specifications

TECHNICAL SPECIFICATIONS

STRAIGHT LENGTHS / DIVIDERS / COVERS

30 mm deep tray (CF30) / 54 mm deep tray (CF54)	38 - 39
FASCLIC AUTO (FCFA54) / FASCLIC (FCF54)	40 - 41
80 mm (CF80) / 105 mm (CF105) / 150 mm (CF150) deep tray	42 - 43
G-tray (CFG) / underfloor tray (UF30)	44
Mini tray (TXF35) / flexible tray (G-MINI)	45
Straight length dividers (COT) / bend dividers (COTFIL)	46
Covers (CVN / CP) / cover clips (F01/02/03)	47

COUPLERS AND FIXING KITS

Length to length couplers (EDRN / AUTOCLIC)	48
Joint strips (ED275 / ED1100)	49
Connectors (FASLOCK AUTO / FASSTRUT 41)	49 / 51
Base couplers (CEFAS / R15/25/35)	50
Fixing kits and components	51

WALL MOUNTING

Base and side wire mounting (UC50 / CAT30 / CAT40 / CM50 CM50XL)	52 - 55
Cantilever arms / mounting rails (CSN / CSNC / CG / CB / CU / CLN / CC21S / EDF / RE41SP)	56 - 62
Stand-off brackets (R15/25/35/55)	63
Fast fix support rails (RCSN)	65

CEILING MOUNTING

Central hangers (SF50/100 / SL50 / CEQ / UC50 / SAS / CE40 / CM50XL / SCF / UCS)	66 - 71
Trapeze hangers (AS / RCSN / EDF)	71 - 75
Profile mounting (CSNC)	73
Pendant mounting (EDF / PFREDF / RE41SP / PFR41S)	76 - 77

FLOOR / BEAM / OTHER MOUNTING

Floor mounting (CM50XL / RCSN / R15/25/35/55 / FTX / UC50 / UFC)	78 - 82
Beam mounting (CLMFAS / CLMU / EF)	83 - 85
Take-off plates (SBDN / SBD / EXSBD)	86
Universal mounting plates (CM50 / CM50XL / CAT40 / CM50XXL / CM50WL)	87 - 88
Luminaire supports (SL50/100)	89
Multifix base plates (MFM / MFPOLYA)	89
Cabling accessories (FAS ROLLER / DEV100 / CLIP / PA)	90 - 92
Earthing (BLF / GRIFEQUIP / GRIFEQUIP 2)	92 - 93

straight lengths - CF30
technical information

■ **Dimensions and weights**

↓ 30 mm ↖ 50 mm → 600 mm ↔ 3 m

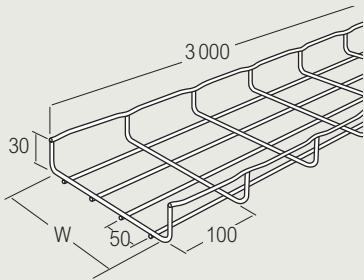

Safety edge

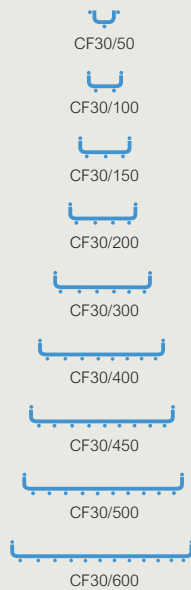

Cat. Nos.	W mm	Weight (kg/3 m)			
		EZ	GC	304L	316L
CF30/50 ¹	50	1.19	1.23	1.15	1.15
CF30/100	100	1.61	1.67	1.56	1.56
CF30/150	150	2.05	2.13	1.99	1.99
CF30/200	200	2.84	2.95	2.76	2.76
CF30/300	300	4.39	4.56	4.09	4.09
CF30/400	400	6.85	-	-	-
CF30/450	450	7.33	-	-	-
CF30/500	500	7.82	-	-	-
CF30/600	600	8.78	-	-	-

1 : No safety edge

Please use Cat. No. when placing your order, see p. 11

All weights are given in Kilograms (kg) and are for a 3 m straight length

Sheared steel (particularly stainless steel) does have relatively sharp edges and protective gloves must be worn during handling

All dimensions (mm) are nominal

■ **Loading graphs**

The permissible load stated in this catalogue represents the load that Cablofil steel wire cable tray is guaranteed to be able to bear. It assumes loads are evenly spread and is given in daN/m. The standard permits a deflection equivalent to 1/100th of the span. Legrand imposes a stricter limit of 1/200th for both safety and aesthetic reasons. For example, Legrand voluntarily restricts deflection to 10 mm for a span of 2 m, whereas the standard would allow 20 mm.

Load tests carried out to IEC 61537 (safety factor 1.7 + joint 1/5th of the way along the span). Permissible load should include all cable loads and any other additional loads (eg: wind, snow)

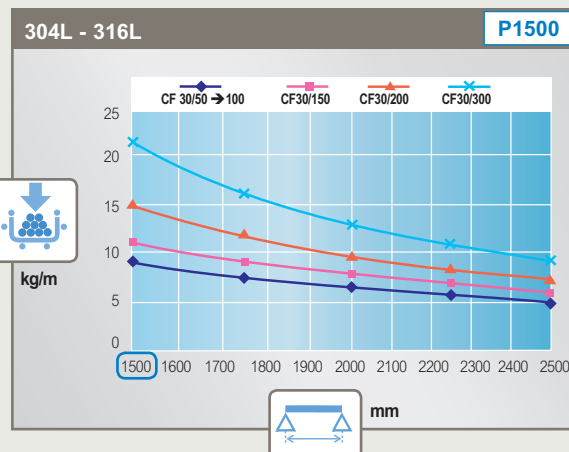
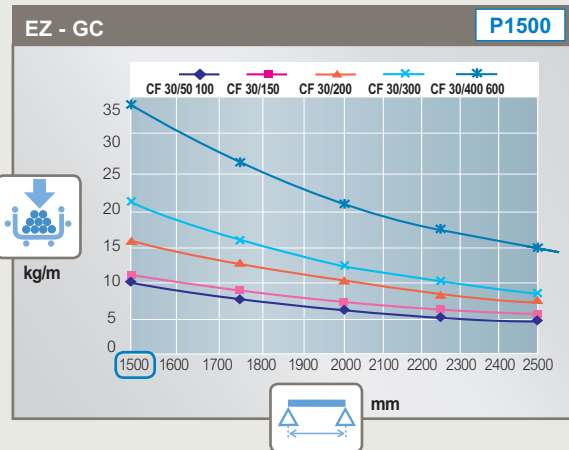

P1500 = supports at 1 500 mm, see p. 120 for more information

NOTE:

For more information on loadings, see p. 125

■ **Finishes**

Standard stocked finish :

EZ Electrogalvanising after manufacture

Additional finishes :

GC Hot dip galvanised after manufacture

304L Stainless steel 304L

316L Stainless steel 316L

For detailed information related to finishes, refer to p. 116-117

→ **Couplers : see p. 48-51**

→ **Dividers : see p. 46**

straight lengths - CF54

technical information

■ Dimensions and weights

54 mm 50 mm → 600 mm 3 m

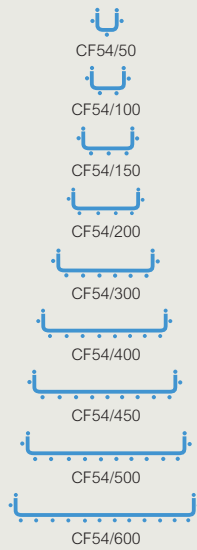
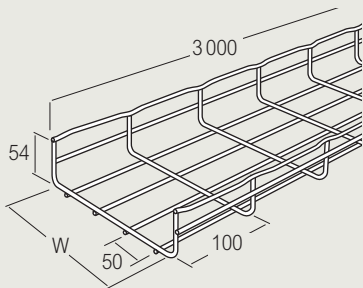

Cat. Nos.	W mm	Weight (kg/3 m)				
		EZ	EZ+	GC	304L	316L
CF54/50	50	1.89	1.97	1.97	1.84	1.84
CF54/100	100	2.33	2.42	2.42	2.26	2.26
CF54/150	150	3.13	3.25	3.25	2.69	2.69
CF54/200	200	4.07	4.23	4.23	3.50	3.50
CF54/300	300	6.13	6.37	6.37	5.14	5.14
CF54/400	400	9.15	9.51	9.51	7.92	7.92
CF54/450	450	9.79	10.17	10.17	8.49	8.49
CF54/500	500	10.42	10.83	10.83	9.06	9.06
CF54/600	600	11.69	12.15	12.15	10.20	10.20

Please use Cat. No. when placing your order, see p. 11

All weights are given in Kilograms (kg) and are for a 3 m straight length

Sheared steel (particularly stainless steel) does have relatively sharp edges and protective gloves must be worn during handling

All dimensions (mm) are nominal

■ Loading graphs

The permissible load stated in this catalogue represents the load that Cablofil steel wire cable tray is guaranteed to be able to bear. It assumes loads are evenly spread and is given in daN/m. The standard permits a deflection equivalent to 1/100th of the span. Legrand imposes a stricter limit of 1/200th for both safety and aesthetic reasons. For example, Legrand voluntarily restricts deflection to 10 mm for a span of 2 m, whereas the standard would allow 20 mm.

Load tests carried out to IEC 61537 (safety factor 1.7 + joint 1/5th of the way along the span). Permissible load should include all cable loads and any other additional loads (eg: wind, snow)

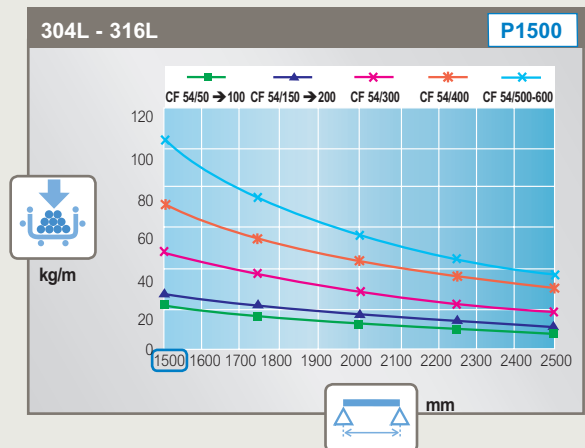
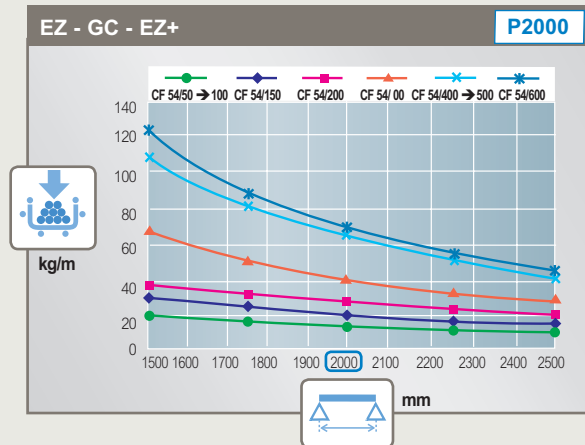

P2000 = supports at 2 000 mm, see p. 120 for more information

P1500 = supports at 1 500 mm, see p. 120 for more information

NOTE:

For more information on loadings, see p. 125

■ Finishes

Standard stocked finish :

EZ Electrogalvanising after manufacture

Additional finishes :

EZ+ Organically coated electrogalvanised after manufacture

GC Hot dip galvanised after manufacture

304L Stainless steel 304L

316L Stainless steel 316L

For detailed information related to finishes, refer to p. 116-117

→ Couplers : see p. 48-51

→ Dividers : see p. 46

straight lengths - FCFA54 (FASCLIC AUTO)
 technical information

■ **Dimensions and weights**

54 mm → 50 mm → 600 mm → 3 m

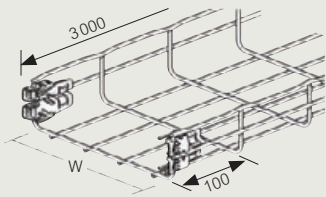

Safety edge



Cat. Nos.	W mm	Weight (kg) EZ
FCFA54/50	50	1.97
FCFA54/100	100	2.40
FCFA54/150	150	3.20
FCFA54/200	200	4.15
FCFA54/300	300	6.23
FCFA54/400	400	9.26
FCFA54/450	450	9.89
FCFA54/500	500	9.89
FCFA54/600	600	10.53

Please use Cat. No. when placing your order, see p. 12

All weights are given in Kilograms (kg) and are for a 3 m straight length

■ **Assembly**

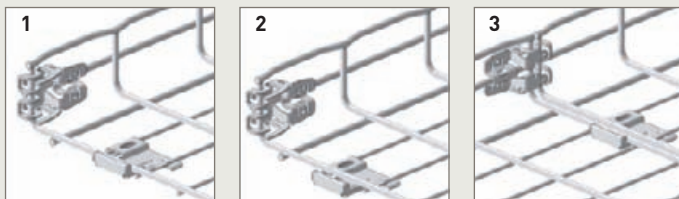

Unclip integral couplers from delivery position. Slide base plate (if applicable) to accept secondary length. Clip coupler and base to secure

For 300 - 600 mm wide tray, additional base plates are supplied to aid connection (1 x for 300 mm, 2 x for 400 - 500 mm and 3 x for 600 mm tray)

If a length of FCFA is cut, the coupler and base plate can be removed and reattached

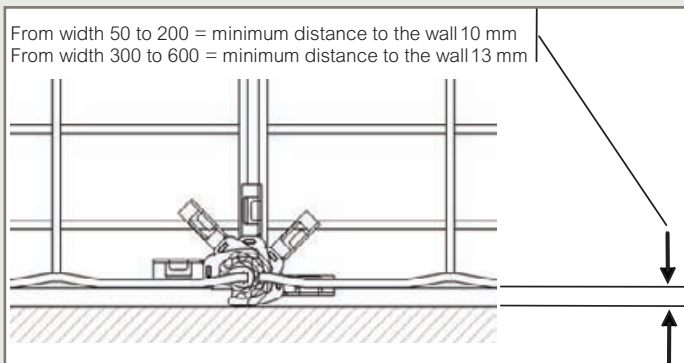

Patented



Fast assembling



Fixing without nuts and bolts

Sheared steel (particularly stainless steel) does have relatively sharp edges and protective gloves must be worn during handling

All dimensions (mm) are nominal

■ **Loading graphs**

The permissible load stated in this catalogue represents the load that Cablofil steel wire cable tray is guaranteed to be able to bear. It assumes loads are evenly spread and is given in daN/m. The standard permits a deflection equivalent to 1/100th of the span. Legrand imposes a stricter limit of 1/200th for both safety and aesthetic reasons. For example, Legrand voluntarily restricts deflection to 10 mm for a span of 2 m, whereas the standard would allow 20 mm.

Load tests carried out to IEC 61537 (safety factor 1.7 + joint 1/5th of the way along the span). Permissible load should include all cable loads and any other additional loads (eg: wind, snow)

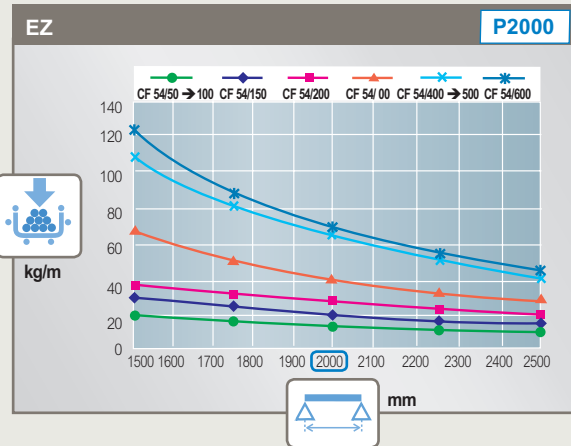

P2000 = supports at 2 000 mm, see p. 120 for more information

NOTE:

For more information on loadings, see p. 125

■ **Finishes**

Standard stocked finish :

EZ Electrogalvanising after manufacture

For detailed information related to finishes, refer to p. 116-117

→ **Dividers : see p. 46**

straight lengths - FCF54 (FASCLIC)

technical information

■ Dimensions and weights

54 mm → 50 mm → 300 mm → 3 m

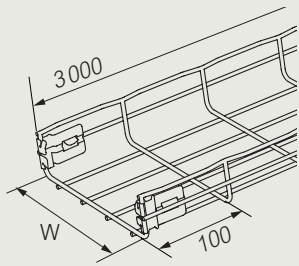

Safety edge



Cat. Nos.	W mm	Weight (kg/3 m)	
		304L	316L
FCF54/50	50	2.03	2.03
FCF54/100	100	2.46	2.46
FCF54/150	150	3.46	3.46
FCF54/200	200	4.02	4.02
FCF54/300	300	5.34	5.34

Please use Cat. No. when placing your order, see p. 12

All weights are given in Kilograms (kg) and are for a 3 m straight length

■ Assembly

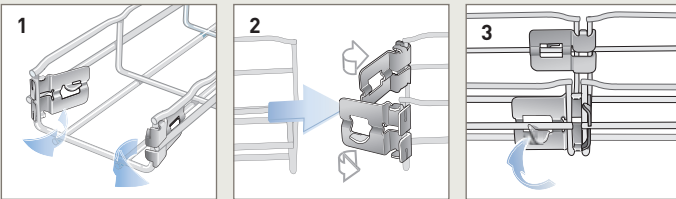

Unclip integral couplers from delivery position, offer secondary length and press couplers outwards. Bend tabs to secure using screwdriver. No additional fasteners required.



Patented



Fast assembling



Fixing without nuts and bolts

■ Loading graphs

The permissible load stated in this catalogue represents the load that Cablofil steel wire cable tray is guaranteed to be able to bear. It assumes loads are evenly spread and is given in daN/m. The standard permits a deflection equivalent to 1/100th of the span. Legrand imposes a stricter limit of 1/200th for both safety and aesthetic reasons. For example, Legrand voluntarily restricts deflection to 10 mm for a span of 2 m, whereas the standard would allow 20 mm.

Load tests carried out to IEC 61537 (safety factor 1.7 + joint 1/5th of the way along the span). Permissible load should include all cable loads and any other additional loads (eg: wind, snow)

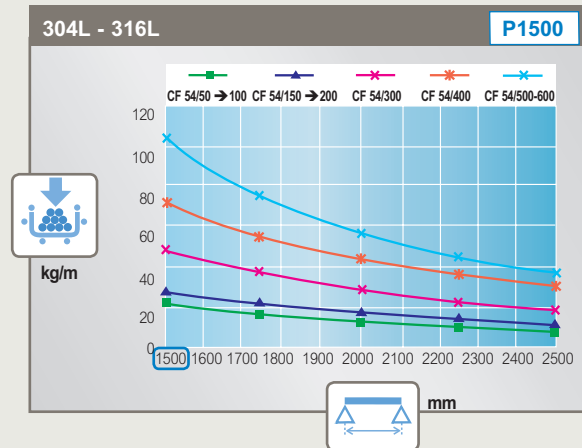

P1500 = supports at 1 500 mm, see p. 120 for more information

NOTE:

For more information on loadings, see p. 125

■ Finishes

Available finishes :

304L Stainless steel 304L

316L Stainless steel 316L

For detailed information related to finishes, refer to p. 116-117



Sheared steel (particularly stainless steel) does have relatively sharp edges and protective gloves must be worn during handling

All dimensions (mm) are nominal

→ Dividers : see p. 46

straight lengths - CF105
technical information

■ **Dimensions and weights**

105 mm 100 mm → 600 mm 3 m

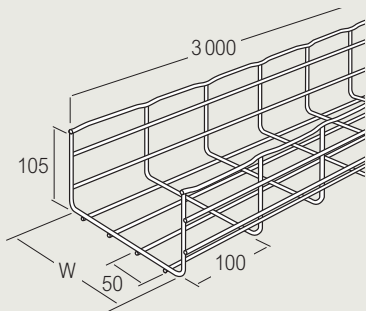

Safety edge

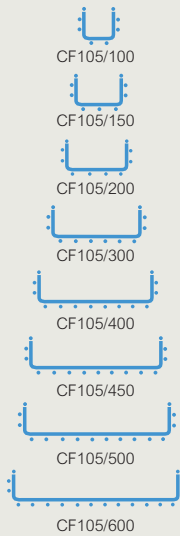

Cat. Nos.	W mm	Weight (kg/3 m)			
		EZ	GC	304L	316L
CF105/100	100	4.07	4.23	3.50	3.50
CF105/150	150	5.23	5.43	3.97	3.97
CF105/200	200	6.13	6.37	5.14	5.14
CF105/300	300	9.15	9.51	7.92	7.92
CF105/400	400	10.42	10.83	9.06	9.06
CF105/450	450	11.25	11.40	9.45	9.45
CF105/500	500	11.69	12.15	9.63	9.63
CF105/600	600	12.96	13.46	10.20	10.20

Please use Cat. No. when placing your order, see p. 13
All weights are given in Kilograms (kg) and are for a 3 m straight length

■ **Loading graphs**

The permissible load stated in this catalogue represents the load that Cablofil steel wire cable tray is guaranteed to be able to bear. It assumes loads are evenly spread and is given in daN/m. The standard permits a deflection equivalent to 1/100th of the span. Legrand imposes a stricter limit of 1/200th for both safety and aesthetic reasons. For example, Legrand voluntarily restricts deflection to 10 mm for a span of 2 m, whereas the standard would allow 20 mm.

Load tests carried out to IEC 61537 (safety factor 1.7 + joint 1/5th of the way along the span). Permissible load should include all cable loads and any other additional loads (eg: wind, snow)

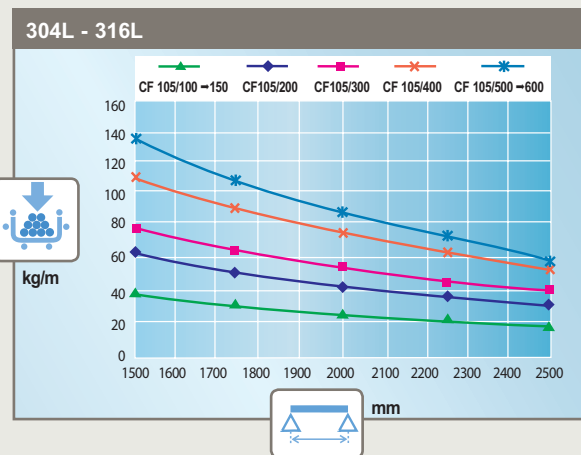
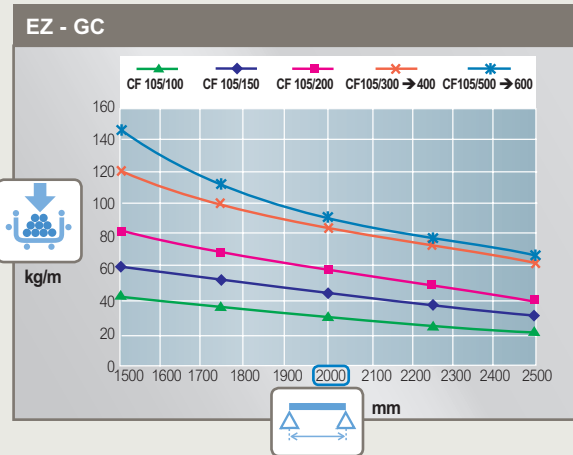

NOTE:
For more information on loadings, see p. 125

■ **Finishes**

Standard stocked finish :

EZ Electrogalvanising after manufacture

Additional finishes :

GC Hot dip galvanised after manufacture

304L Stainless steel 304L

316L Stainless steel 316L

For detailed information related to finishes, refer to p. 116-117

Sheared steel (particularly stainless steel) does have relatively sharp edges and protective gloves must be worn during handling

All dimensions (mm) are nominal

→ **Couplers : see p. 48-51**

→ **Dividers : see p. 46**

straight lengths - CF80

technical information

■ Dimensions and weights

↓ 80 mm → 100 mm → 500 mm → 3 m

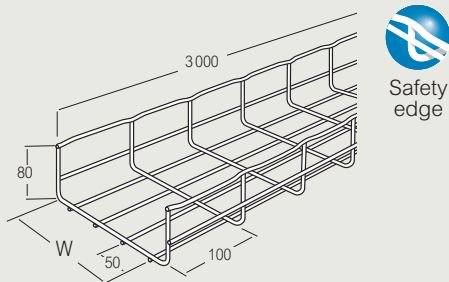

Cat. Nos.	W mm	Weight (kg/3 m)	
		EZ	GC
CF80/100	100	2.84	2.95
CF80/200	200	4.39	4.56
CF80/300	300	6.85	7.12
CF80/400	400	7.82	8.12
CF80/500	500	8.78	9.12

Please use Cat. No. when placing your order, see p. 13

All weights are given in Kilograms (kg) and are for a 3 m straight length

■ Loading graphs

The permissible load stated in this catalogue represents the load that Cablofil steel wire cable tray is guaranteed to be able to bear. It assumes loads are evenly spread and is given in daN/m. The standard permits a deflection equivalent to 1/100th of the span. Legrand imposes a stricter limit of 1/200th for both safety and aesthetic reasons. For example, Legrand voluntarily restricts deflection to 10 mm for a span of 2 m, whereas the standard would allow 20 mm.

Load tests carried out to IEC 61537 (safety factor 1.7 + joint 1/5th of the way along the span). Permissible load should include all cable loads and any other additional loads (eg: wind, snow)

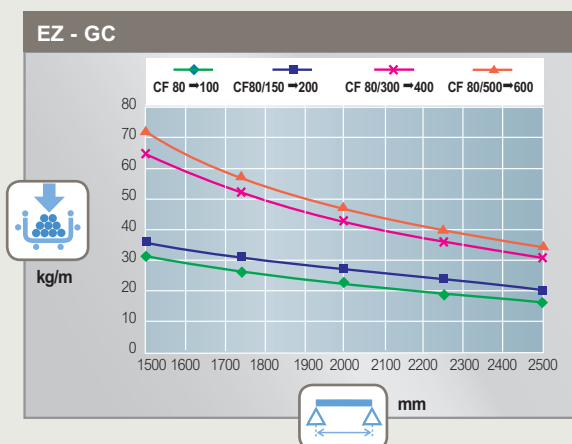

NOTE:
For more information on loadings, see p. 125

■ Finishes

Available finishes :

- EZ** Electro galvanising after manufacture
- GC** Hot dip galvanised after manufacture

For detailed information related to finishes, refer to p. 116-117

All dimensions (mm) are nominal

straight lengths - CF150

technical information

■ Dimensions and weights

↓ 150 mm → 200 mm → 500 mm → 3 m

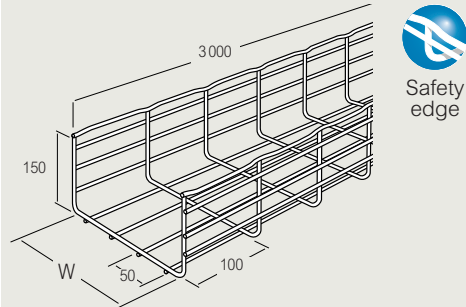

Cat. Nos.	W mm	Weight (kg/3 m)	
		EZ	GC
CF150/200	200	9.15	9.51
CF150/300	300	10.42	10.83
CF150/400	400	11.69	12.15
CF150/450	450	12.33	12.96
CF150/500	500	12.43	13.00

Please use Cat. No. when placing your order, see p. 13

All weights are given in Kilograms (kg) and are for a 3 m straight length

■ Loading graphs

The permissible load stated in this catalogue represents the load that Cablofil steel wire cable tray is guaranteed to be able to bear. It assumes loads are evenly spread and is given in daN/m. The standard permits a deflection equivalent to 1/100th of the span. Legrand imposes a stricter limit of 1/200th for both safety and aesthetic reasons. For example, Legrand voluntarily restricts deflection to 10 mm for a span of 2 m, whereas the standard would allow 20 mm.

Load tests carried out to IEC 61537 (safety factor 1.7 + joint 1/5th of the way along the span). Permissible load should include all cable loads and any other additional loads (eg: wind, snow)

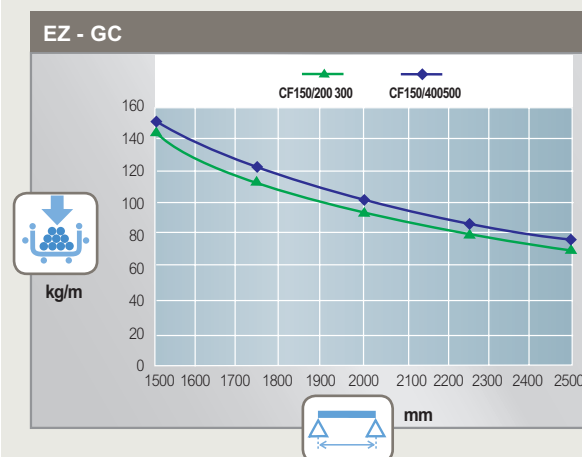

NOTE:
For more information on loadings, see p. 125

■ Finishes

Available finishes :

- EZ** Electro galvanising after manufacture
- GC** Hot dip galvanised after manufacture

For detailed information related to finishes, refer to p. 116-117

straight lengths - CFG
technical information

■ **Dimensions and weights**

50 mm → 100 mm → 200 mm → 3 m

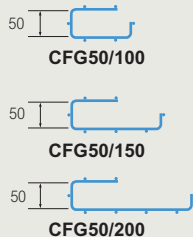
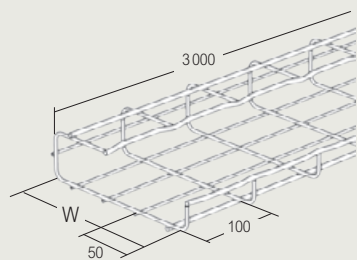

Cat. Nos.	W mm	Weight (kg/3 m)	
		EZ	GC
CFG50/100	100	2.84	2.95
CFG50/150	150	3.32	3.45
CFG50/200	200	4.39	4.56

Please use Cat. No. when placing your order, see p. 14

All weights are given in Kilograms (kg) and are for a 3 m straight length

■ **Installation**

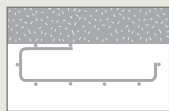

Ceiling mounted
Use CE40 (see p. 69) and fasteners
(not supplied)

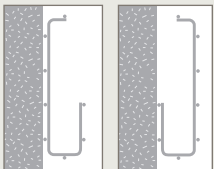

Wall mounted either
by base or by
G section. Use
CE40 (see p.69)
and fasteners (not
supplied)

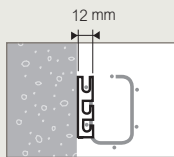

Wall mounted
using CM50XL
universal
mounting plate
See **p. 55**

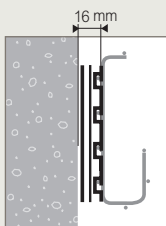

Wall mounted
using RCSN fast
fit support rail
See **p. 65**

■ **Finishes**

Available finishes :

EZ Electrogalvanising after manufacture

GC Hot dip galvanised after manufacture

For detailed information related to finishes, refer to **p. 116-117**

Sheared steel (particularly stainless steel) does have relatively sharp edges and protective gloves must be worn during handling

All dimensions (mm) are nominal

→ Couplers : see p. 48-51

→ Dividers : see p. 46

**straight lengths - UF30 (for
cavity floor installations only)**
technical information

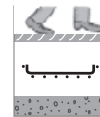

■ **Dimensions and weights**

30 mm → 300 mm → 500 mm → 3 m

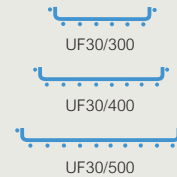
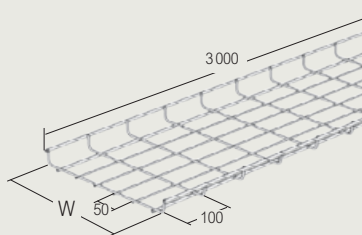

Cat. Nos.	W mm	Weight (kg)
		EZ
UF30/300	300	3.87
UF30/400	400	4.80
UF30/500	500	5.74

Please use Cat. No. when placing your order, see p. 14

All weights are given in Kilograms (kg) and are for a 3 m straight length



Recommended support
spacing = 1000 mm

■ **Finishes**

Standard stocked finish :

EZ Electrogalvanising after manufacture

For detailed information related to finishes, refer to **p. 116-117**

→ Couplers : see p. 48-51

mini steel wire cable tray – TXF35

technical information

■ Dimensions and weights

35 mm 35 mm 3 m

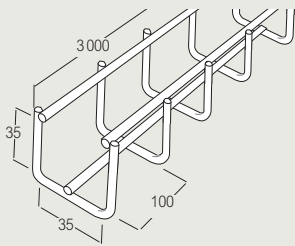

No safety edge

Cat. Nos.	Weight (kg/3 m)			
	EZ	GC	304L	316L
TXF35	1.50	1.80	1.40	1.40

Please use Cat. No. when placing your order, see p. 15

All weights are given in Kilograms (kg) and are for a 3 m straight length

■ Installation

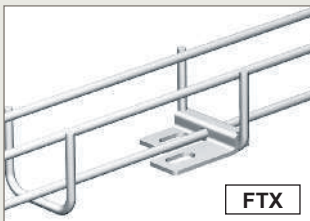

FTX

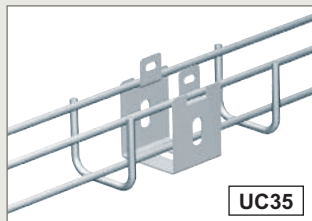

UC35

Use FTX and fasteners (not supplied) to secure TXF35 steel wire cable tray to the floor

Use UC35 and fasteners to secure TXF35 steel wire cable tray to the wall or floor

■ Assembly

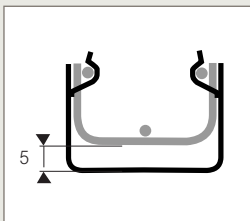
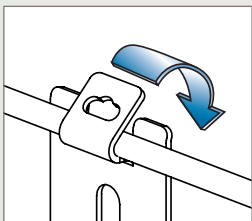

Bend tabs with pliers to secure to steel wire cable tray

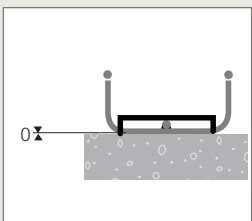

Clip FTX over base wire of the tray and secure to floor using fasteners (not supplied)

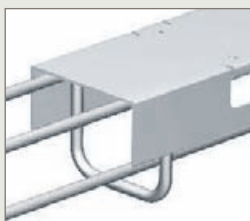

CP35 covers, (see p. 15) simply clip into place



Fast assembling



Fixing without nuts and bolts

■ Finishes

Standard stocked finish :

EZ Electrogalvanising after manufacture

Additional finishes :

GC Hot dip galvanised after manufacture

304L Stainless steel 304L

316L Stainless steel 316L

For detailed information related to finishes, refer to p. 116-117

flexible steel wire cable tray – G-MINI

technical information

■ Dimensions and weights

50 mm 50 mm 3 m

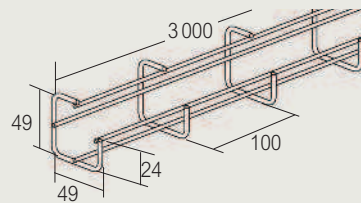

No safety edge

Cat. Nos.	Weight (kg/3 m)	
	EZ	316L
G-MINI	1.20	1.15

Please use Cat. No. when placing your order, see p. 15

All weights are given in Kilograms (kg) and are for a 3 m straight length

■ Installation

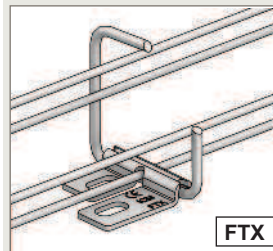

FTX

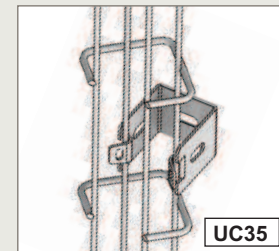

UC35

Use FTX and fasteners (not supplied) to secure G-MINI steel wire cable tray to the wall or floor

Use UC35 and fasteners to secure G-MINI steel wire cable tray to the wall or floor

■ Assembly

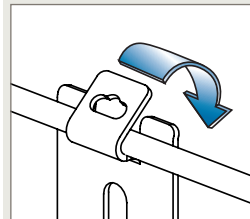

Bend tabs with pliers to secure to steel wire cable tray

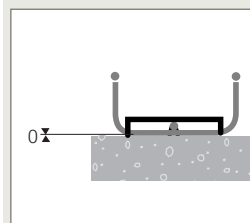

Clip FTX over base wire of the tray and secure to floor using fasteners (not supplied)



Fast assembling



Fixing without nuts and bolts

■ Finishes

Standard stocked finish :

EZ Electrogalvanising after manufacture

Additional finishes :

316L Stainless steel 316L

For detailed information related to finishes, refer to p. 116-117



Sheared steel (particularly stainless steel) does have relatively sharp edges and protective gloves must be worn during handling

All dimensions (mm) are nominal

straight length dividers – COT / COT J

technical information

■ **COT – dividers**
COTJ – divider connectors

■ **Dimensions and weights**

COT \updownarrow 30 mm \rightarrow 105 mm \leftrightarrow 100 mm \rightarrow 600 mm \rightleftarrows 3 m

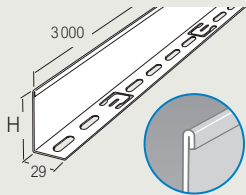

COT dividers have a return safety edge

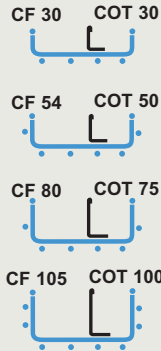

Cat. Nos.	H mm	Weight (kg/3 m)		
		GS	GC	316L
COT30	24	0.3	0.3	0.3
COT50	48	0.5	0.5	0.5
COT75	72	0.7	0.7	–
COT100	96	0.9	0.9	0.9

Please use Cat. No. when placing your order, see p. 16

All weights are given in Kilograms (kg) and are for a 3 m straight length

COTJ \updownarrow 30 mm \rightarrow 105 mm \leftrightarrow 100 mm \rightarrow 600 mm

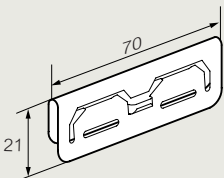

Cat. No.	Weight (kg)	
	GS	316L
COT J	0.1	0.1

Please use Cat. No. when placing your order, see p. 16

All weights are given in Kilograms (kg) and are per unit (each)

■ **Installation**



Use COT dividers and COTJ divider connectors along the tray length to separate cable runs

■ **Assembly**



Fold tab in base to secure to the base of the tray length
COTJ dividers clip into place over the joint of two dividers

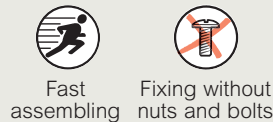

Key :

GS	Pre-galvanised
GC	Hot dip galvanised after manufacture
316L	Stainless steel 316L

For detailed information related to finishes, refer to **p. 116-117**

Sheared steel (particularly stainless steel) does have relatively sharp edges and protective gloves must be worn during handling

All dimensions (mm) are nominal

bend dividers – COTFIL

technical information

■ **COTFIL – bend dividers**

■ **Dimensions and weights**

\updownarrow 30 mm \rightarrow 105 mm \leftrightarrow 100 mm \rightarrow 600 mm

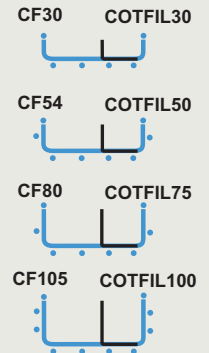
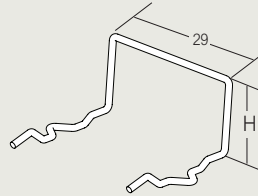

Cat. Nos.	H mm	Weight (kg)	
		EZ	304L
COTFIL30	24	0.05	0.05
COTFIL50	44	0.05	0.05
COTFIL75	71	0.05	0.05
COTFIL100	94	0.05	0.05

Please use Cat. No. when placing your order, see p. 16

All weights are given in Kilograms (kg) and are for a 3 m straight length

■ **Installation**

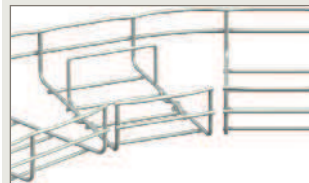

Use COTFIL dividers on fabricated bends to separate cable runs

■ **Assembly**



Clip COTFIL dividers into place by inserting the end under the base wires of the tray

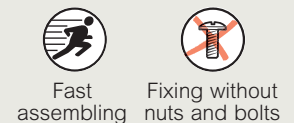

Key :

EZ	Electrogalvanising after manufacture
304L	Stainless steel 304L

For detailed information related to finishes, refer to **p. 116-117**

All dimensions (mm) are nominal

→ How to fabricate bends : see p. 98-101

covers and cover clips – CVN - CP - F01 - F02 - F03

technical information

- CVN – covers (1 m length)
- CP – covers (2 m length)
- F01 / F02 / F03 – cover clips

CVN - covers

Supplied in packs of 3 x 1 m lengths, CVN covers are available for 50 mm to 600 mm wide steel wire cable tray in 30 mm to 105 mm depths

CP - covers

Supplied in packs of 1 x 2 m lengths, CP covers are available for 50 mm to 600 mm wide steel wire cable tray in 30 mm to 105 mm depths

F01 / F02 / F03 - cover clips

Supplied in packs of 25, F01 clips are used with 30 mm deep tray; F02 clips are used with 54 mm and 105 mm deep tray and F03 clips are used with 80 mm deep tray. Clips can be used with both CVN and CP covers

Installation

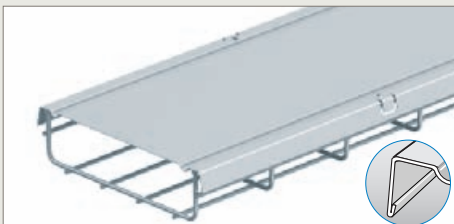

CVN and CP covers can be fitted directly with integral tabs or alternatively with optional cover clips



Use optional cover clips to secure covers

Assembly

Securing CVN / CP covers to steel wire cable tray

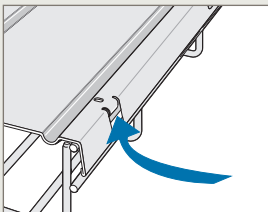

Fast assembling



Fixing without nuts and bolts

Securing F01/F02/F03 cover clips to CVN / CP covers

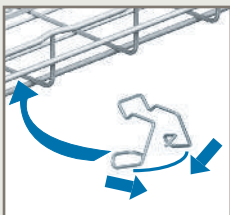

Squeeze clips at base and apply to underside of tray



Fast assembling



Fixing without nuts and bolts

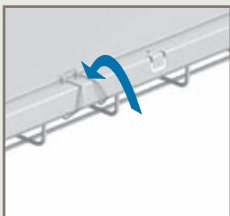

Fix the top of the clip into the groove along the edge of the lid to secure

Dimensions and weights

CVN - \downarrow 30 - 105 mm \rightarrow 50 \rightarrow 600 mm \rightarrow 1 m

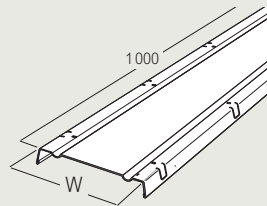

Cat. Nos.	W mm	kg kg/m	Weight (kg)			
			GS	GC	304L	316L
CVN50	71	0.4	1.80	1.95	1.81	1.81
CVN100	121	0.7	2.52	2.73	2.52	2.52
CVN150	171	1.1	3.21	3.48	-	3.21
CVN200	221	1.4	3.93	4.26	-	3.90
CVN300	322	2.0	5.37	5.79	-	-
CVN400	425	3.5	8.52	9.84	-	-
CVN450	475	3.4	9.39	10.86	-	-
CVN500	525	4.3	10.29	11.88	-	-
CVN600	625	5.0	12.06	13.92	-	-

CP - \downarrow 30 \rightarrow 105 mm \rightarrow 50 \rightarrow 600 mm \rightarrow 2 m

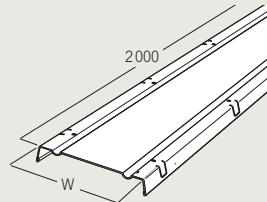

Cat. Nos.	W mm	kg kg/m	Weight (kg)		
			GS	GC	316L
CP50	71	0.4	1.21	1.31	1.21
CP100	121	0.7	1.68	1.82	1.68
CP150	171	1.1	2.15	2.33	2.15
CP200	221	1.4	2.62	2.84	2.62
CP300	322	2.0	3.57	3.87	3.57
CP400	425	3.5	5.68	6.56	6.05
CP450	475	3.4	6.95	7.40	6.90
CP500	525	4.3	8.85	9.92	7.31
CP600	625	5.0	12.03	13.28	8.57

F01/F02/F03 - \downarrow 30 \rightarrow 105 mm \rightarrow 50 \rightarrow 600 mm

F01

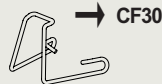

F02



F03

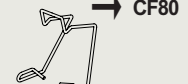

Cat. No.	Weight (kg)	
	GS	316L
F01/2/3	0.1	0.1

Please use Cat. No. when placing your order, see p. 17

All weights are given in Kilograms (kg) and are per unit (each)

Key :

GS Pre-galvanised	304L Stainless steel 304L
GC Hot dip galvanised after manufacture	316L Stainless steel 316L

For detailed information related to finishes, refer to p. 116-117

→ Straight lengths : see p. 38-44

couplers – length to length
EDRN - AUTOCLIC

■ **EDRN – couplers**

EDRN couplers are supplied with one fixing tool in each pack of 50 couplers. No additional fasteners or tools required

■ **Installation**

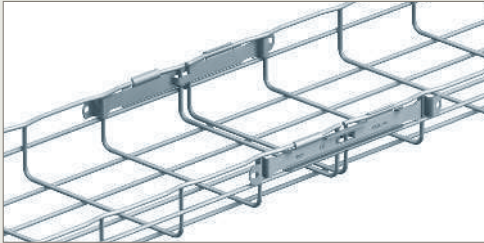

EDRN couplers are used in pairs across the side rail joint of two lengths of tray as shown

■ **Assembly**

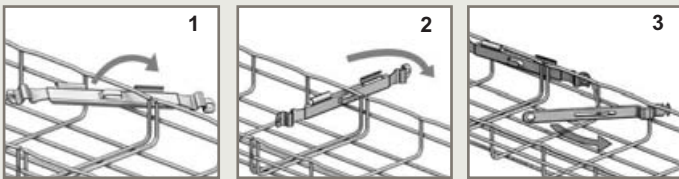

1. Position coupler as indicated
2. Twist coupler into place
3. Use fixing tool (supplied) to pull coupler into place



Patented



Fast assembling



Fixing without nuts and bolts

The table below indicates the recommended quantity of EDRN couplers required per width of steel wire cable tray
Note: for base coupling, CEFAS (p. 50) can be used as an alternative to EDRN couplers

A → ← A = side coupling = base coupling

Coupler	50		100		150		200		300		400 → 500		600	
	A	B	A	B	A	B	A	B	A	B	A	B	A	B
CF30	2	0	2	0	2	0	2	1	2	1	2	2	2	3
CF54	2	0	2	0	2	0	2	1	2	1	2	2	2	3
CF80	-	-	2	1	-	-	2	2	2	2	2	3	2	3
CF105	-	-	2	1	2	1	2	2	2	3	2	3	2	3
CF150	-	-	-	-	-	-	2	2	2	3	2	3	2	3
CFG	-	-	2	1	2	1	2	1	-	-	-	-	-	-

■ **Dimensions and weights**

↕ 30 → 150 mm ↔ 50 → 600 mm

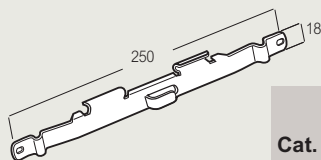

Cat. Nos.	Weight (kg)		
	EZ	DC	316L
EDRN	0-07	0-07	0-07

Please use Cat. No. when placing your order, see p. 18

All weights are given in Kilograms (kg)

All dimensions (mm) are nominal

Key : EZ Electrogalvanising after manufacture	316L Stainless steel 316L
DC Geomet	For detailed information related to finishes, refer to p. 116-117

→ Straight lengths : see p. 38-44

■ **AUTOCLIC – couplers**

AUTOCLIC couplers are supplied in packs of 50. Rapid fit with screwdriver. No additional fasteners required

■ **Installation**

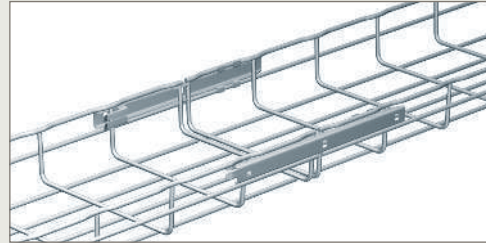

AUTOCLIC couplers are used in pairs across the side rail joint of two lengths of tray as shown

■ **Assembly**

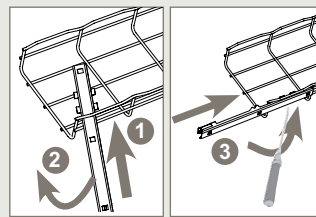

1. Insert coupler
2. Twist into position
3. Pull into place with screwdriver (not supplied)



Fast assembling



Fixing without nuts and bolts



Patented

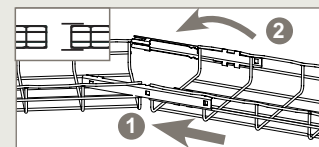

Fit Autoclic to both sides of one length of tray and insert into second length as shown

OR

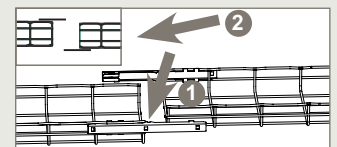

Fit Autoclic in an offset pattern on alternate ends of each length as shown

The table below indicates the recommended quantity of AUTOCLIC couplers required per width of steel wire cable tray
Note: wider widths need the addition of either CEFAS (p. 50) or KITASSTR (p. 51) to provide additional support to the base

A → ← A = side coupling = base coupling

Coupler	50		100		150 / 200		300		400 → 500		600	
	A	B	A	B	A	B	A	B	A	B	A	B
CF54	2	0	2	0	2	0	2	1	2	2	2	3
CF105	-	-	2	0	2	1	2	2	⊕	⊕	⊕	⊕
CFG	-	-	2	1	2	1	2	1	-	-	-	-

■ **Dimensions and weights**

↕ 54 / 105 mm ↔ 50 → 600 mm

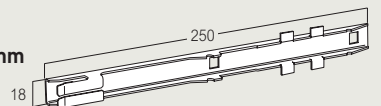

Cat. Nos.	Weight (kg)			
	GS	GC	304L	316L
AUTOCLIC	0-09	0-10	0-10	0-10

Please use Cat. No. when placing your order, see p. 18

All weights are given in Kilograms (kg)

Key : GS Pre-galvanised	304L Stainless steel 304L
GC Hot dip galvanised after manufacture	316L Stainless steel 316L

For detailed information related to finishes, refer to p. 116-117

joint strips – length to length coupling

ED275 - ED1100

Use to provide additional support for length to length coupling. Fasteners are required to secure joint strips to the tray (see below). ED275 supplied in packs of 50 without fasteners. ED1100 supplied singly without fasteners. Not suitable for 30 mm or 80 mm deep tray.

Installation

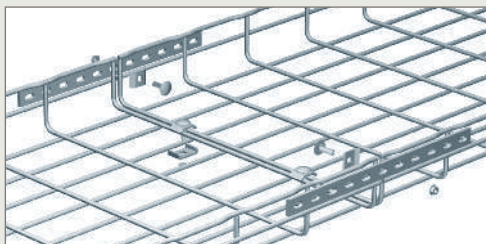

Joint strips attach to the side wire of the tray across the joint when used as a length to length coupler. Fasteners required (not supplied)

Assembly

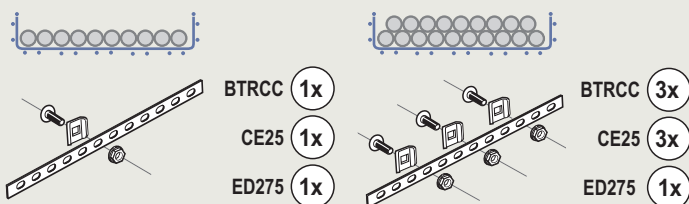

For lighter loads, use a single fastener

For heavier loads, increase the number of fasteners

The table below indicates the recommended quantity of ED275/ED1100 joint strips per width and also KITASSTR (p. 50) as a base coupler

A → ← A = side coupling B = base coupling (CAA)

↕	50		100		150		200		300		400		500		600	
	A	B	A	B	A	B	A	B	A	B	A	B	A	B	A	B
CF54	2	0	2	0	2	0	2	0	2	1	2	2	2	2	3	3
CF105	-	-	2	1	2	1	2	1	2	2	2	2	3	2	3	3
CF150	-	-	-	-	-	-	2	2	2	2	2	3	2	3	2	3
CFG	-	-	2	1	2	1	2	1	-	-	-	-	-	-	-	-

Dimensions and weights

↕ 54 / 105 / 150 mm ↔ 50 → 600 mm

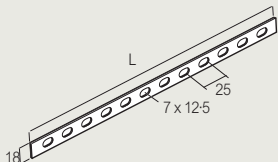

Cat. No.	L mm	Weight (kg)			
		EZ	GC	304L	316L
ED275	275	0-08	0-10	0-08	0-08
ED1100	1000	0-49	0-55	-	0-38

Please use Cat. No. when placing your order, see p. 18

All weights are given in Kilograms (kg)

All dimensions (mm) are nominal

Key :	EZ	GC	304L	316L
	Electrogalvanising after manufacture	Hot dip galvanised after manufacture	Stainless steel 304L	Stainless steel 316L

For detailed information related to finishes, refer to p. 116-117

→ Straight lengths : see p. 38-44

couplers – fabricated fittings

FASLOCK AUTO

FASLOCK AUTO is used to form radius bends. For 100 mm and 200 mm wide steel wire cable tray use FASLOCK AUTO S (small). For 300 mm wide to 600 mm wide tray use FASLOCK AUTO XL (large). Supplied in packs of 25. No additional fasteners or tools required. For detailed installation instructions see p. 97-99

Installation

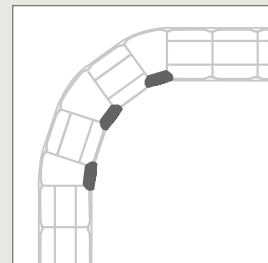
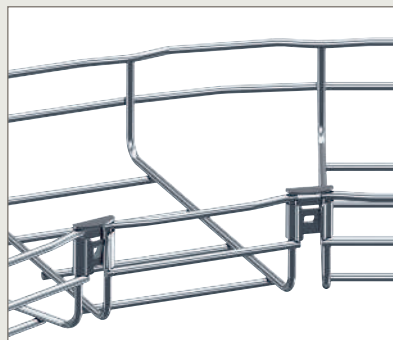

FASLOCK AUTO is positioned on the internal angle of a radius bend after steel wire cable tray has been cut. No fasteners required

Assembly

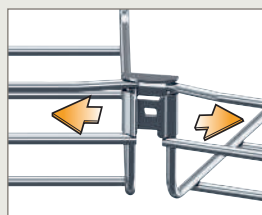

Clip FASLOCK AUTO into place. Safety edges protect both the cables and the installer



Patented



Fast assembling



Fixing without nuts and bolts

Dimensions and weights

↕ 30 → 150 mm ↔ 100 → 600 mm



Cat. Nos.	Weight (kg)		
	EZ	DC	316L
FASLOCK AUTO S	0-01	0-01	0-01
FASLOCK AUTO XL	0-01	0-01	0-01

Please use Cat. No. when placing your order, see p. 18

All weights are given in Kilograms (kg)

All dimensions (mm) are nominal

Key :	EZ	DC	316L
	Electrogalvanising after manufacture	Geomet	Stainless steel 316L

For detailed information related to finishes, refer to p. 116-117

→ Creating a radius bend : see p. 98-101

→ Installing FASLOCK AUTO : see p. 97-99

base couplers – length to length
CEFAS - R15/25/35

■ **CEFAS – base couplers**

CEFAS couplers are used as base couplers or in conjunction with EDRN or AUTOCLIC as side rail couplers (p. 48). Can also be used as a luminaire support. Supplied in packs of 50. No additional fasteners or tools required

Installation

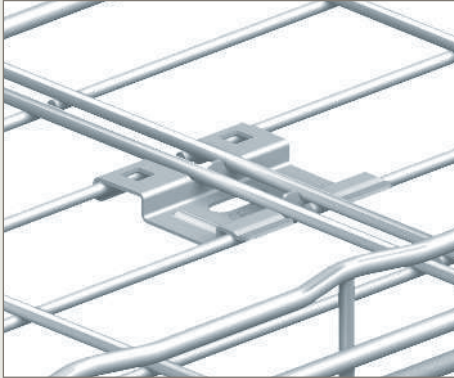

CEFAS used as a base coupler between two lengths of steel wire cable tray. No fasteners required

■ **Assembly**

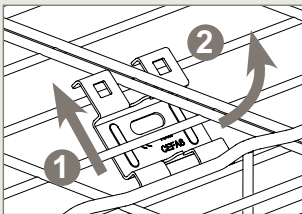

1. and 2. insert CEFAS into the base of the tray as shown

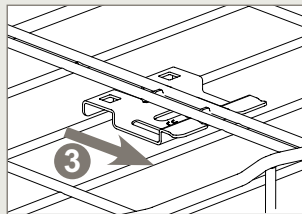

3. slide into place to secure
 No fasteners required

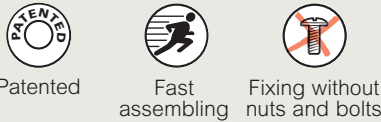

■ **Dimensions and weights**

↕ 30 → 150 mm ↔ 100 → 600 mm

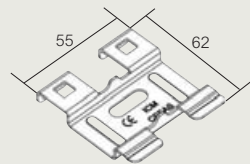

Cat. Nos.	Weight (kg)		
	GS	DC	316L
CEFAS	0-03	0-04	0-34

Please use Cat. No. when placing your order, see p. 18

All weights are given in Kilograms (kg)

All dimensions (mm) are nominal

Key :	GS Pre-galvanised	316L Stainless steel 316L
	DC Geomet	

For detailed information related to finishes, refer to **p. 116-117**

→ Straight lengths : see p. 38-44

■ **R15/25/35 – stand-off brackets**

Use to fix 100 mm to 600 mm wide steel wire cable tray in 30 mm to 150 mm depths directly onto the floor. For 200 mm and 300 mm wide tray, use 2 x brackets per length. For 400 mm to 600 mm wide tray, use 3 x brackets per length. Can also be used for wall mounting (see p. 63). Incorporate slot and tab design for easy fixing. Supplied singly without fasteners

■ **Installation**

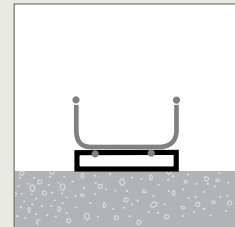
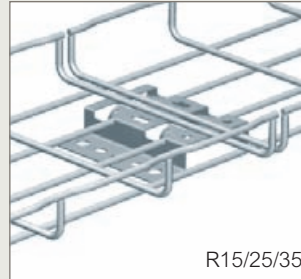

Mount tray runs on the floor using R15/25/35 and fasteners (not supplied)

■ **Assembly**

Securing stand-off brackets to steel wire cable tray



FAS LOT
 FAST ASSEMBLING SYSTEM

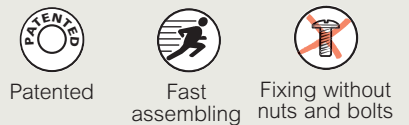

Slot base wires of the tray into the stand-off bracket and bend tabs with screwdriver to secure, as shown in the FAS diagram above

■ **Dimensions and weights**

↕ 30 → 105 mm ↔ 100 → 600 mm

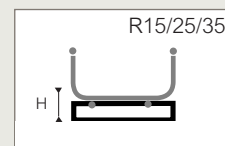
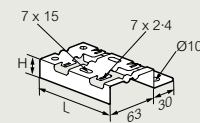

Cat. No.	H mm	L mm	FL daN	Weight (kg)		
				GS	Z+	316L
R15/100	15	98	100	0-14	0-09	0-09
R15/300	15	300	100	0-38	0-41	–
R25	25	98	100	0-13	0-12	–
R35	35	98	50	0-15	0-14	–

Please use Cat. No. when placing your order, see p. 18

All weights are given in Kilograms (kg)

All dimensions (mm) are nominal

Key :	GS Pre-galvanised	316L Stainless steel 316L
	Z+ Continuous galvanisation before manufacture	

For detailed information related to finishes, refer to **p. 116-117**

→ For wall mounting : see p. 63

→ For floor mounting : see p. 79

fixing components – channel fixings FASTRUT 41

Use to secure steel wire cable tray to channel support or channel type cantilever arms. Supplied in packs of 50. No additional fasteners required

Installation



FASTRUT 41 in situ holding steel wire cable tray down to channel length

Assembly

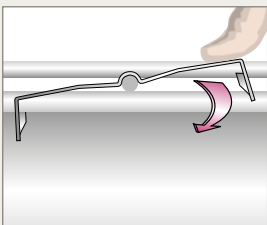

Patented



Fast assembling



Fixing without nuts and bolts

Push fit FASTRUT 41 on to base wire of the tray and clip into position

Dimensions and weights

CF30/CF54/CF105 100 → 600 mm



Cat. No.	L mm	Weight (kg)	
		DC	316L
FS41	73	0-01	0-01

Please use Cat. No. when placing your order, see p. 18

All weights are given in Kilograms (kg)

All dimensions (mm) are nominal

Key : **DC** Geomet

316L Stainless steel 316L

For detailed information related to finishes, refer to p. 116-117

→ Straight lengths : see p. 38-44

fixing kits – length to length coupling KITASSTR - KITASSVS - KITINOX

Use for length to length coupling. Supplied in packs of 50

Installation

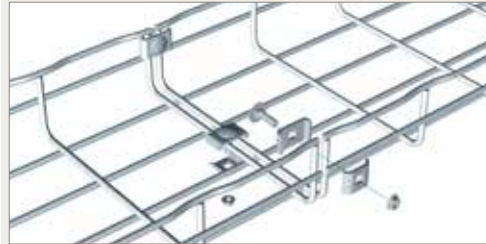

Fixing kits can be used to join two straight lengths. Use on both side wire and base of tray

Assembly

The table below indicates the recommended quantity of fixing kits required to couple straight lengths together

A → ← A = side coupling = base coupling

	50		100		150		200		300		400 → 450		500		600		
	A	B	A	B	A	B	A	B	A	B	A	B	A	B	A	B	
CF30 - CF54	2	0	2	1	2	1	2	1	2	2	2	2	2	2	2	2	3
CF80	-	-	2	1	-	-	2	1	2	2	2	2	2	2	3	2	3
CF105	-	-	2	1	2	1	2	1	2	2	2	3	2	3	2	3	3
CF150	-	-	-	-	-	-	2	2	2	2	2	3	2	3	2	3	3
CFG	-	-	2	1	2	1	2	1	-	-	-	-	-	-	-	-	-

Dimensions and weights

KITASSTR

= CE25 + CE30 + BTRCC 6 x 20

KITFIXVS

= CE25 + EEC6

KITASSVS

= CE25VS + CE30ES

KITINOX

= CE25VS + CE30 + EEC6

KITFIXTR

= CE25 + BTRCC 6 X 20

Cat. Nos.	Weight (kg)				
	EZ	GC	DC	304L	316L
KITASSTR	0-03	-	0-03	-	0-03
KITASSVS	0-03	-	0-03	-	-
KITFIXTR	0-02	-	-	-	-
KITFIXVS	0-02	-	-	-	-
KITINOX	-	-	-	-	0-03
CE25	0-01	-	0-01	0-01	0-01
CE30	0-01	-	0-01	0-01	0-01
BTRCC6 x 20	0-01	-	0-01	0-01	0-01

Please use Cat. No. when placing your order, see p. 19

All weights are given in Kilograms (kg)

All dimensions (mm) are nominal

Key :	EZ Electrogalvanising after manufacture	304L Stainless steel 304L
	DC Geomet	316L Stainless steel 316L
	GC Hot dip galvanised after manufacture	For detailed information related to finishes, refer to p. 116-117

→ Straight lengths : see p. 38-44

wall mounting – light duty
UC50

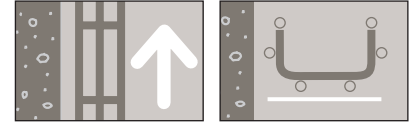

■ **UC50 – support cradles**

Use as a support cradle for 50 mm wide steel wire cable tray in 30 mm or 54 mm depths
Can be mounted directly onto the wall - horizontally or vertically, or onto wall mounted cantilever arms using fasteners (see below for assembly information)
Can also be ceiling mounted in conjunction with CEQ (see p. 67) or floor mounted (see p. 80). Supplied singly without fasteners

■ **Installation**

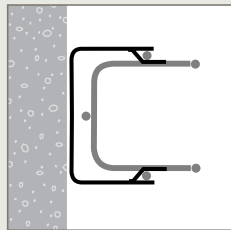
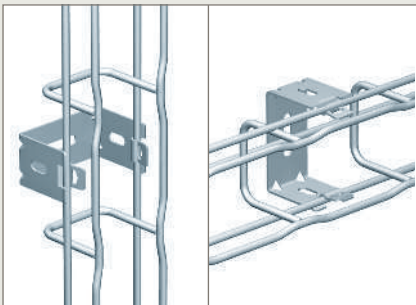
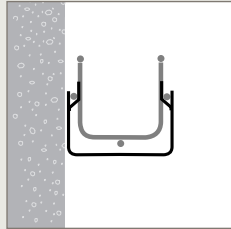
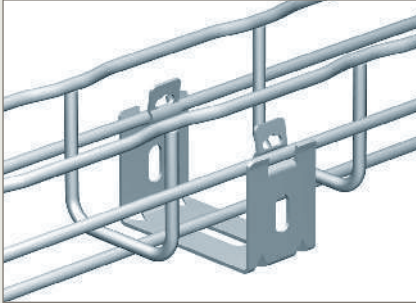

Mount directly onto wall using fasteners (not supplied)

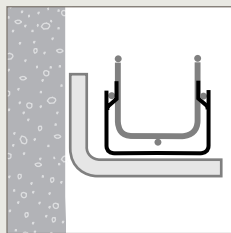
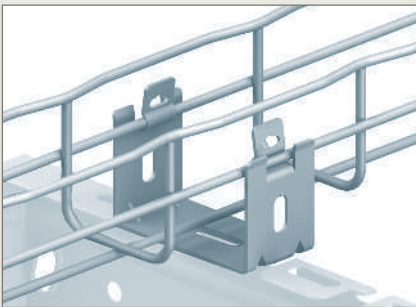

Mount onto wall mounted cantilever arms using fasteners (not supplied)

■ **Assembly**

Securing UC50 to steel wire cable tray

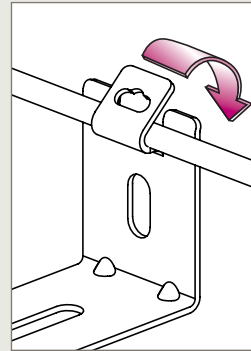

Fast assembling



Fixing without nuts and bolts

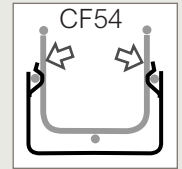
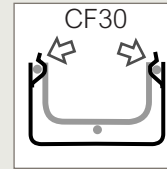

Bend tabs with screwdriver to secure to steel wire cable tray

Securing UC50 to cantilever arm

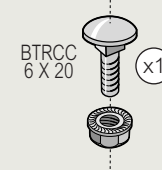

Use BTRCC 6 x 20 (see p. 35) to secure to cantilever arms

■ **Dimensions and weights**

↕ 30 → 54 mm ↔ 50 mm

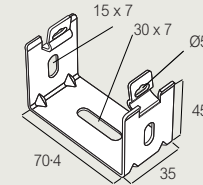

Cat. Nos.	↓ daN	Weight (kg)			
		GS	GC	304L	316L
UC50	12	0-06	0-07	0-06	0-06

Please use Cat. No. when placing your order, see p. 20

All weights are given in Kilograms (kg)

Key :	GS	Pre-galvanised	304L	Stainless steel 304L
	GC	Hot dip galvanised after manufacture	316L	Stainless steel 316L

For detailed information related to finishes, refer to p. 116-117

All dimensions (mm) are nominal

→ For ceiling mounting : see p. 67

→ For cantilever arms : see p. 56-62

wall mounting – light duty

CAT30

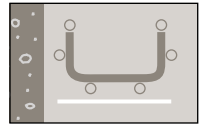

■ CAT30 – cantilever arm / wall fixing plates

Use to fix 50 mm wide steel wire cable tray in 30 mm or 54 mm depths directly onto the wall or onto wall mounted cantilever arms using fasteners (see below for assembly information)
Supplied singly without fasteners

■ Installation

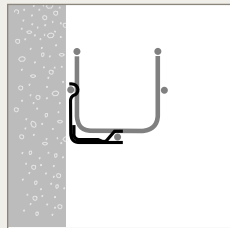

Mount directly onto the wall using fasteners (not supplied)

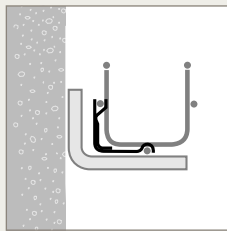

Mount onto wall mounting cantilever arms using fasteners (not supplied)

■ Assembly

Securing CAT30 to steel wire cable tray

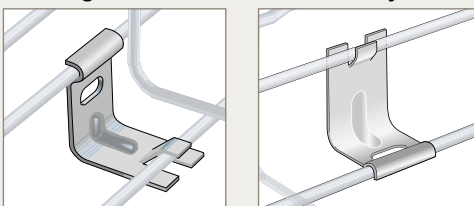

Click to secure to steel wire cable tray



Fixing without nuts and bolts

Securing CAT30 to cantilever arms

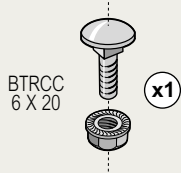

Use BTRCC 6 x 20 (see p. 35) to secure to cantilever arms

■ Dimensions and weights

↓ 30 → 54 mm ← 50 mm



Cat. Nos.	↓ daN	Weight (kg)			
		GS	DC	304L	316L
CAT30	20	0.03	0.03	0.03	0.03

Please use Cat. No. when placing your order, see p. 20

All weights are given in Kilograms (kg)

Key :	GS Pre-galvanised	304L Stainless steel 304L
	GC Hot dip galvanised after manufacture	316L Stainless steel 316L

For detailed information related to finishes, refer to p. 116-117

All dimensions (mm) are nominal

→ For cantilever arms : see p. 56-62

wall mounting – light duty
CAT40

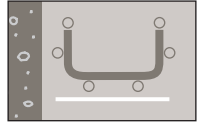

■ **CAT40 – channel / wall fixing plates**

Use to fix 50 mm wide steel wire cable tray in 30 mm or 54 mm depths directly onto the wall or onto wall mounted channel support. Attach to wall or channel support using fasteners (see below for assembly information). Can also be clipped onto most steel wire cable trays as an ancillary mounting plate (see p. 87). Supplied singly without fasteners.

■ **Installation**

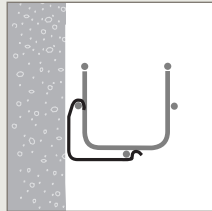
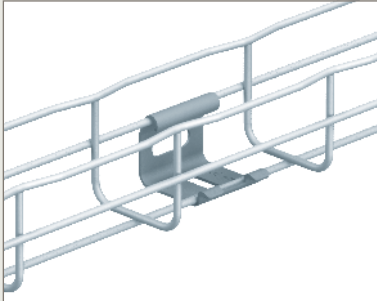

Mount directly onto wall using fasteners (not supplied)

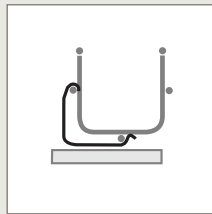
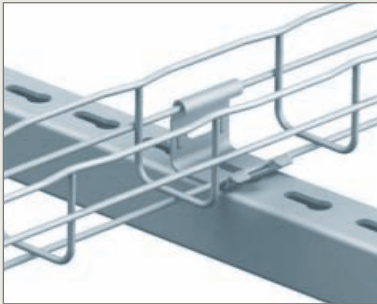

Mount onto wall mounted channel support using fasteners (not supplied)

■ **Assembly**

Securing CAT40 to steel wire cable tray

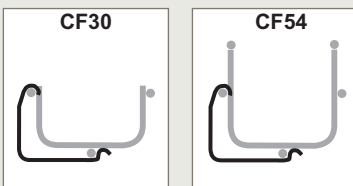

Click to secure to steel wire cable tray



Fixing without nuts and bolts

Securing CAT40 to channel support

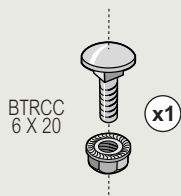

Use BTRCC 6 x 20 (see p. 35) to secure to channel support

■ **Dimensions and weights**

↑↓ 30 → 54 mm ↔ 50 mm

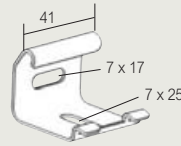

Cat. Nos.	↓ F daN	Weight (kg)			
		GS	DC	316L	304L
CAT40	20	0.04	0.04	0.04	0.04

Please use Cat. No. when placing your order, see p. 20

All weights are given in Kilograms (kg)

Key :

GS	Pre-galvanised	304L	Stainless steel 304L
DC	Geomet	316L	Stainless steel 316L

For detailed information related to finishes, refer to **p. 116-117**

All dimensions (mm) are nominal

wall mounting – medium duty

CM50 – CM50XL

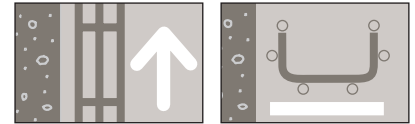

■ CM50 – universal mounting plates (small)

Use to fix 50 mm wide steel wire cable tray in 54 mm depth directly onto the wall using the side rail of tray
Use for horizontal mounting of steel wire cable tray runs. Incorporates slot and tab design for easy fixing
Can also be clipped onto most steel wire cable trays as an ancillary mounting plate (see p. 87). Supplied singly without fasteners

■ Installation

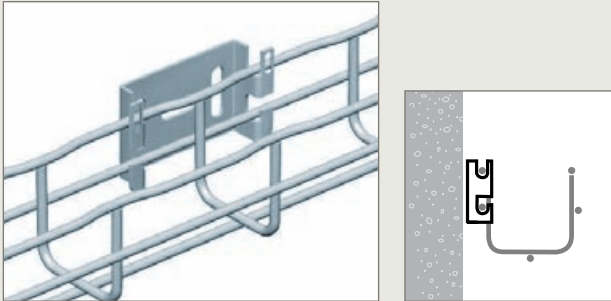

Mount directly onto wall using fasteners (not supplied)

■ Assembly

Securing CM50 to steel wire cable tray

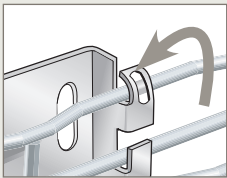

Bend tabs with screwdriver to secure to steel wire cable tray



Fast assembling



Fixing without nuts and bolts

■ Dimensions and weights

54 mm 50 mm

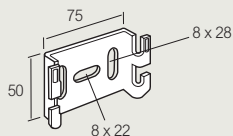

Cat. Nos.	Weight (kg)			
	GS	GC	304L	316L
CM50	0-08	0-08	0-07	0-07

Please use Cat. No. when placing your order, see p. 20

All weights are given in Kilograms (kg)

Key :	Pre-galvanised		Stainless steel 304L	
	GS	GC	304L	316L
	Hot dip galvanised after manufacture		Stainless steel 316L	

For detailed information related to finishes, refer to p. 116-117

All dimensions (mm) are nominal

■ CM50XL – universal mounting plates (large)

Use to fix 50 mm to 100 mm wide steel wire cable tray in 54 mm and 80 mm depths directly onto the wall using side rail of tray, and 100 mm to 600 mm wide tray in 30 mm to 105 mm depths (including CFG) using base of tray. Can be used for horizontal and vertical mounting of cable tray runs. Can also be used for ceiling mounting (see p. 69) and floor mounting (see p. 78). Incorporates slot and tab design for easy fixing. Supplied singly without fasteners

■ Installation

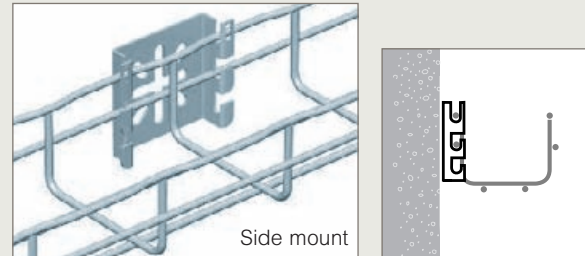

Side mount

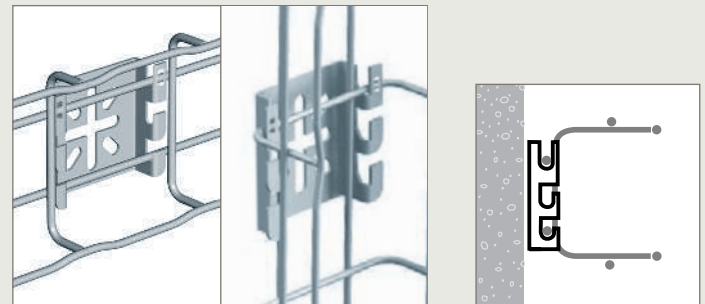

Base mount - horizontal

Base mount - vertical

■ Assembly

Securing CM50XL to steel wire cable tray

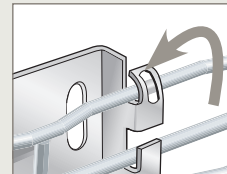

Bend tabs with screwdriver to secure to steel wire cable tray



Fast assembling



Fixing without nuts and bolts

■ Dimensions and weights

54 mm → 80 mm 50 → 100 mm (side rail mounted)

30 mm → 105 mm 100 → 600 mm (base mounted)

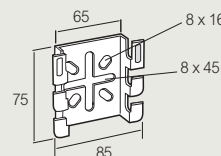

Cat. Nos.	Weight (kg)			
	GS	GC	304L	316L
CM50XL	0-10	0-11	0-08	0-08

Please use Cat. No. when placing your order, see p. 20

All weights are given in Kilograms (kg)

→ For ceiling mounting : see p. 69

→ For floor mounting : see p. 78

wall mounting – medium duty
CSN

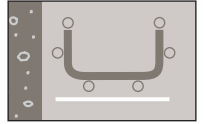

■ **CSN – profile cantilever arms**
INTERFAS – adaptor plate
EPVCSN – end cap

CSN - profile cantilever arms

Use to support 100 mm to 450 mm wide steel wire cable tray in 30 mm and 54 mm depths. Can be wall mounted using fasteners (see below) or pendant drop mounted using EDF mounting rail (see p. 76). Incorporate slot and tab design for easy fixing. Supplied singly without fasteners

INTERFAS - adaptor plate

Used as a tool-less mounting device to attach CSN profile cantilever arms to channel section
Supplied singly

EPVCSN - end cap

PVC end cap for CSN profile cantilever arms
Supplied singly

■ **Installation**

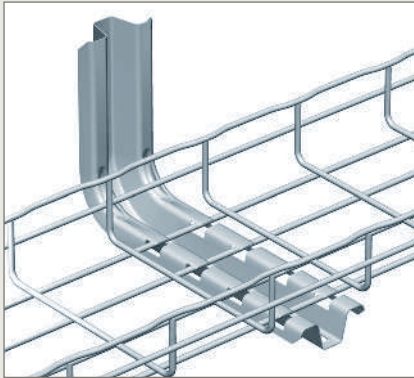

Mount directly onto wall using fasteners (not supplied)

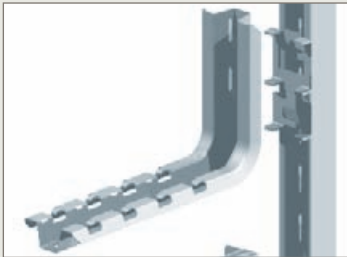

Slot CSN into INTERFAS. No additional fasteners required

■ **Assembly**

Securing CSN to channel

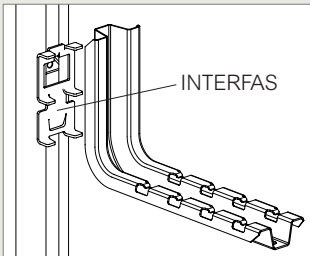

Mount onto wall mounted channel support using INTERFAS

Securing CSN to steel wire cable tray



Patented



Fast assembling



Fixing without nuts and bolts



Slot base wires of the tray into the cantilever arm and bend tabs with screwdriver to secure, as shown in the FAS diagram above

■ **Dimensions and weights**

↓ 30 → 54 mm ↶ 100 → 450 mm

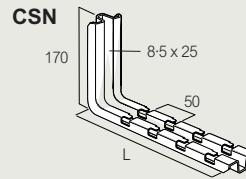

Cat. Nos.	L mm	F daN	Weight (kg)			
			GS	GC	304L	316L
CSN100	178	30	0.37	0.40	0.40	0.40
CSN150	228	110	0.42	0.47	0.41	0.41
CSN200	278	85	0.47	0.53	0.51	0.51
CSN300	378	73	0.73	0.76	0.64	0.64
CSN400	478	56	0.82	0.92	-	-
CSN450	528	50	0.91	0.97	-	-

Please use Cat. No. when placing your order, see p. 21

All weights are given in Kilograms (kg)

INTERFAS

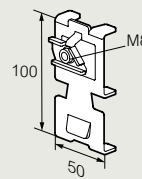

Cat. No.	L mm	Weight (kg)	
		GS	GC
INTERFAS	100	0.08	0.08

Please use Cat. No. when placing your order, see p. 24

All weights are given in Kilograms (kg)

EPVCSN



Cat. No.	Weight (kg)
	PVC
EPVCSN	0.01

Please use Cat. No. when placing your order, see p. 21

All weights are given in Kilograms (kg)

GS	Pre-galvanised	304L	Stainless steel 304L
GC	Hot dip galvanised after manufacture	316L	Stainless steel 316L
PVC	PVC	For detailed information related to finishes, refer to p. 116-117	

All dimensions (mm) are nominal

wall mounting – medium duty CSNC

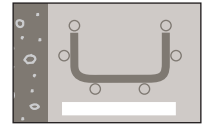

■ CSNC – profile roof cantilever arms

Use to support 100 mm to 450 mm wide steel wire cable tray in 30 mm and 54 mm depths. Can be wall mounted using fasteners (see below) or ceiling mounted (see p. 73). Incorporate slot and tab design for easy fixing. Supplied singly without fasteners

■ Installation

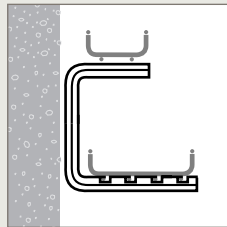
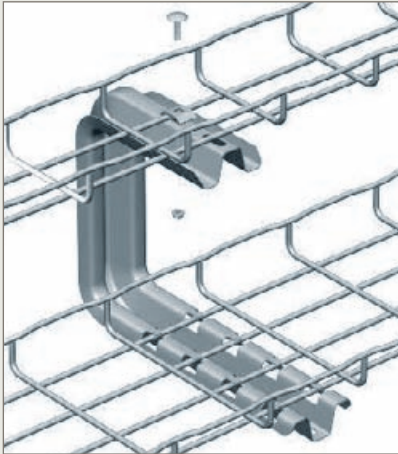

Mount directly onto wall using fasteners (not supplied). Steel wire cable tray can be fitted to the main or profile arm of the cantilever (see assembly detail below)

■ Assembly

CSNC - securing cantilever arm to steel wire cable tray



FAST
FAST ASSEMBLING SYSTEM

Slot base wires of the tray into the cantilever arm and bend tabs with screwdriver to secure, as shown in the FAS diagram

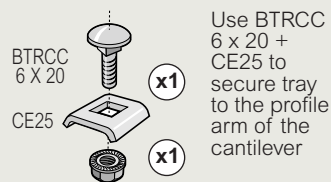

Patented



Fast assembling



Fixing without nuts and bolts

■ Dimensions and weights

30 → 54 mm 100 → 450 mm

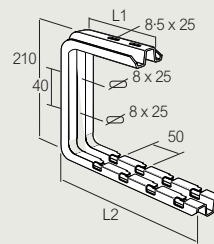

Cat. Nos.	L1 mm	L2 mm	F daN	Weight (kg)		
				GS	GC	316L
CSNC100	170	178	120	0.57	0.65	0.60
CSNC150	170	228	100	0.63	0.72	0.67
CSNC200	170	278	80	0.68	0.80	0.72
CSNC300	288	378	70	1.30	1.35	–
CSNC400	288	478	48	1.36	1.38	–
CSNC450	288	528	44	1.40	1.47	–

Please use Cat. No. when placing your order, see p. 21

All weights are given in Kilograms (kg)

Key : **GS** Pre-galvanised **316L** Stainless steel 316L
GC Hot dip galvanised after manufacture

For detailed information related to finishes, refer to p. 116-117

All dimensions (mm) are nominal

→ For ceiling mounting : see p. 73

wall mounting – medium duty
CB

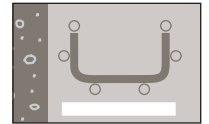

■ **CB – compact cantilever arms for universal mounting**
CB

Use to support 50 to 400 mm wide steel wire cable tray in 30 to 150 mm depths. Mount directly onto wall, channel or EDF mounting rail, (see p. 60). Incorporates slot and tab design for easy fixing. Supplied singly without fasteners

■ **Installation**

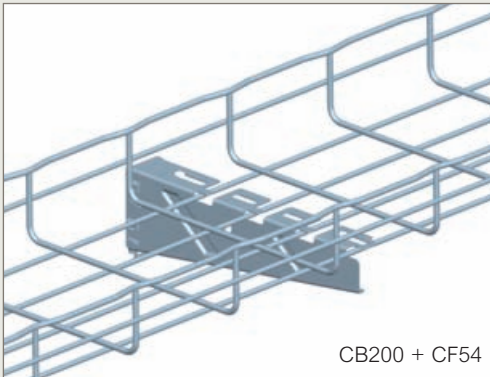

CB200 + CF54

Steel wire cable tray mounted onto CB200

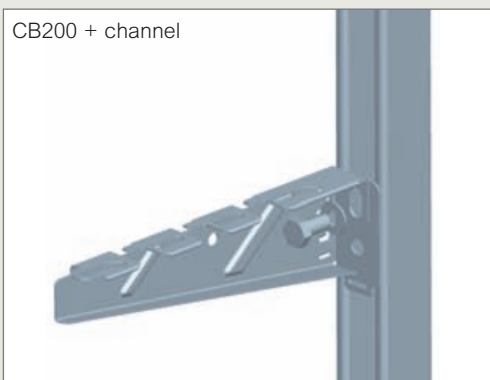

CB200 + channel

CB200 mounted onto channel (fasteners not supplied)

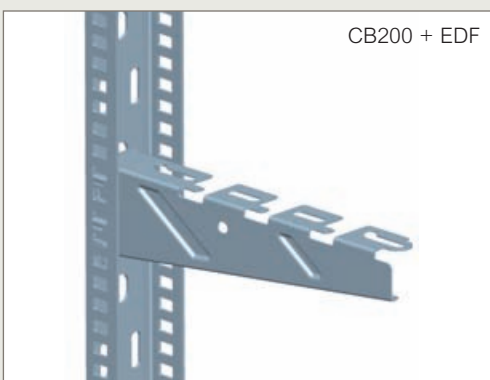

CB200 + EDF

CB200 mounted onto EDF mounting rail

■ **Assembly**



Patented



Fast assembling



Fixing without nuts and bolts

CB - securing cantilever arm to steel wire cable tray



Slot base wires of the tray into the cantilever arm and bend tabs with screwdriver to secure, as shown in the FAS diagram

CB - securing cantilever arm to channel

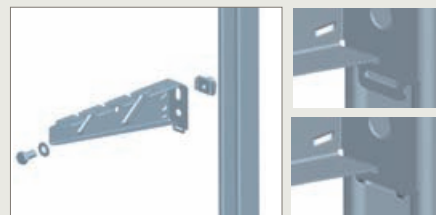

Use channel spring nut and fasteners to secure cantilever arm to channel. Bend bottom tab of cantilever arm for additional support

EDF - CB - securing cantilever arm to mounting rail

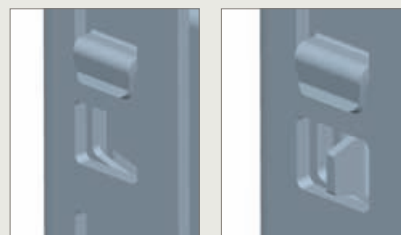

Bend tabs on cantilever arm to secure to the internal edge of the EDF mounting rail. No fasteners required

→ For ceiling (pendant) mounting : see p. 76-77

wall mounting – medium duty CB (continued)

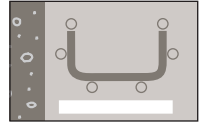

■ Dimensions and weights

CB \updownarrow 30 → 150 mm \leftrightarrow 50 → 400 mm

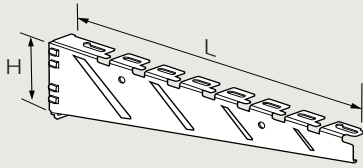

Cat. Nos.	L mm	H mm	Weight (kg)		
			GS	GC	316L
CB50	81	71	0.090	0.096	0.092
CB100	131	71	0.117	0.125	0.120
CB150	181	75	0.162	0.173	0.166
CB200/250	231	75	0.188	0.201	0.193
CB300	335	88	0.348	0.371	0.355
CB400	435	102	0.482	0.514	0.492

Please use Cat. No. when placing your order, see p. 21

All weights are given in Kilograms (kg)

■ Safe working loads

Cat. Nos.	daN		
	Wall	Rail	Channel
CB50	80	50	50
CB100	110	50	50
CB150	100	50	80
CB200/250	110	40	80
CB300	150	40	90
CB400	150	60	100

Key :	GS	Pre-galvanised	304L	Stainless steel 304L
	GC	Hot dip galvanised after manufacture	316L	Stainless steel 316L

For detailed information related to finishes, refer to p. 116-117

All dimensions (mm) are nominal

→ For ceiling (pendant) mounting : see p. 76-77

wall mounting – medium duty

CU – EDF – RE41SP

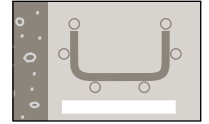

- **CU – cantilever arms - 500-600**
- EDF – pendants / mounting rails**
- RE41SP – pendants / mounting rails (heavy duty)**

CU500-600 - cantilever arms

Use to support 500 mm to 600 mm wide steel wire cable tray in 30 mm to 150 mm depths. Mount directly onto wall or use with EDF or RE41SP mounting rails. Incorporate slot and tab design for easy fixing. Supplied singly without fasteners

EDF - pendants / mounting rails

Use as a wall mounted rail or can be pendant mounted using PFREDF (see p. 76)
Supplied singly without fasteners

RE41SP - pendants / mounting rails (heavy duty)

Use as a wall mounted rail or can be pendant mounted using PFR41S (see p. 77)
Supplied singly without fasteners

■ **Installation**

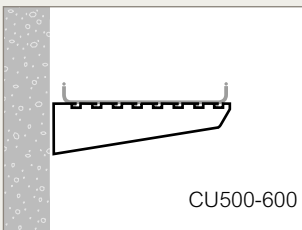

CU500-600

CU mounted directly onto wall using fasteners (not supplied)

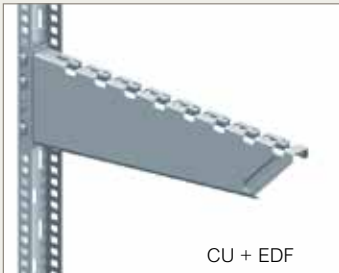

CU + EDF

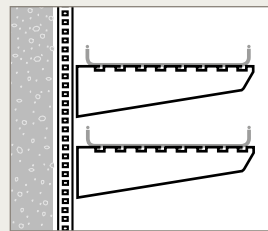

CU mounted onto EDF mounting rail. No fasteners required

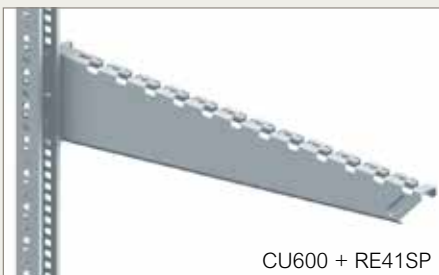

CU600 + RE41SP

Mounted onto RE41SP mounting rail

■ **Assembly**



Patented



Fast assembling



Fixing without nuts and bolts

CU500-600 - securing cantilever arm to steel wire cable tray



Slot base wires of the tray into the cantilever arm and bend tabs with screwdriver to secure, as shown in the FAS diagram

EDF - CU500-600 - securing cantilever arm to mounting rail

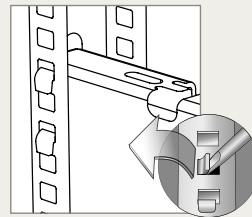

Bend tabs on cantilever arm to secure to the internal edge of the EDF mounting rail. No fasteners required

RE41SP - CU500-600 - securing cantilever arm to mounting rail

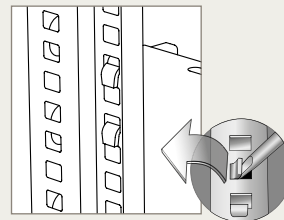

Bend tabs on cantilever arm to secure to the external edge of the RE41SP mounting rail. No fasteners required

■ **Dimensions and weights**

CU \updownarrow 30 → 150 mm \leftrightarrow 500 → 600 mm

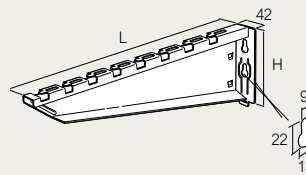

Cat. Nos.	L mm	H mm	F daN		Weight (kg)		
			GS	GC	316L		
CU500	557	138	220	160	1.50	1.61	1.55
CU600	657	138	200	145	1.70	1.83	1.75

Please use Cat. No. when placing your order, see p. 22

All weights are given in Kilograms (kg)

All dimensions (mm) are nominal

→ For ceiling (pendant) mounting : see p. 76-77

wall mounting – medium duty

CU – EDF – RE41SP (continued)

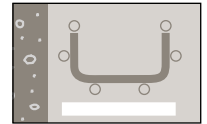

■ CU – cantilever arms - 50-300 and 400-600
 EDF – pendants / mounting rails
 RE41SP – pendants / mounting rails (heavy duty)(continued)

EDF ↓↑ 30 → 150 mm ↔ 100 → 600 mm

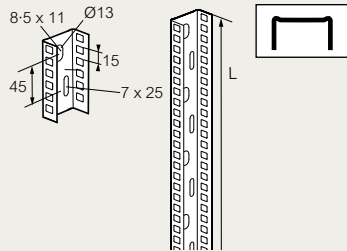

Cat. No.	L mm	↓F daN	Weight (kg)			
			GS	GC	304L	316L
EDF300	270	55	0.33	0.34	–	–
EDF600	600	50	0.77	0.83	–	–
EDF1000	1000	65	1.19	1.24	–	–
EDF2000	2000	70	2.40	2.56	2.48	2.48
EDF3000	3000	100	3.66	3.89	–	–

Please use Cat. No. when placing your order, see p. 24

All weights are given in Kilograms (kg)

■ Dimensions and weights (continued)

RE41SP ↓↑ 30 → 150 mm ↔ 100 → 600 mm

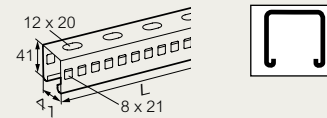

Cat. Nos.	L mm	mm	Weight (kg)
			GS
RE41SP500	500	2	1.30
RE41SP800	800	2	1.90
RE41SP1000	1000	2	2.60
RE41SP3000	3000	2	7.90

Please use Cat. No. when placing your order, see p. 24

All weights are given in Kilograms (kg)

→ For ceiling (pendant) mounting : see p. 76-77

Key :	GS	Pre-galvanised	304L	Stainless steel 304L
	GC	Hot dip galvanised after manufacture	316L	Stainless steel 316L

For detailed information related to finishes, refer to p. 116-117

All dimensions (mm) are nominal

wall mounting – medium duty
CLN – CC21S

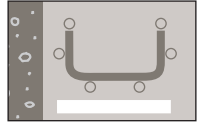

■ **CLN – cantilever arms**

Use to support 100 mm to 300 mm wide steel wire cable tray in 30 mm to 54 mm depths. Wall mount using fasteners. Incorporate slot and tab design for easy fixing. Supplied singly without fasteners

■ **Installation**

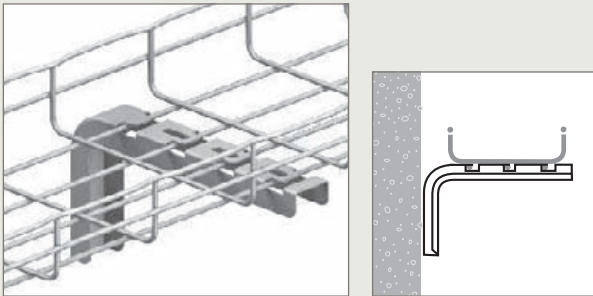

Mount directly onto wall using fasteners (not supplied)

■ **Assembly**

Securing CLN to steel wire cable tray

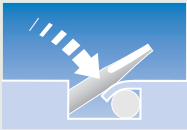

FAS LOT
FAST ASSEMBLING SYSTEM

Slot base wires of the tray into the cantilever arm and bend tabs with screwdriver to secure, as shown in the FAS diagram

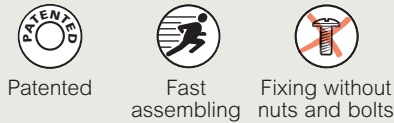

■ **Dimensions and weights**

↕ 30 → 54 mm ↔ 100 → 300 mm

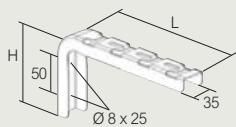

Cat. Nos.	L mm	H mm	F daN	Weight (kg)	
				GS	GC
CLN100	100	125	95	0.16	0.20
CLN150	150	125	70	0.19	0.23
CLN200	200	125	40	0.23	0.27
CLN300	300	125	25	0.29	0.33

Please use Cat. No. when placing your order, see p. 23

All weights are given in Kilograms (kg)

Key : GS Pre-galvanised 316L Stainless steel 316L
GC Hot dip galvanised after manufacture

For detailed information related to finishes, refer to p. 116-117

All dimensions (mm) are nominal

■ **CC21S – cantilever arms**

Use to support 100 mm to 400 mm wide steel wire cable tray in 30 mm to 105 mm depths. Can be wall mounted using fasteners (see below) or pendant drop mounted. Supplied singly without fasteners

■ **Installation**

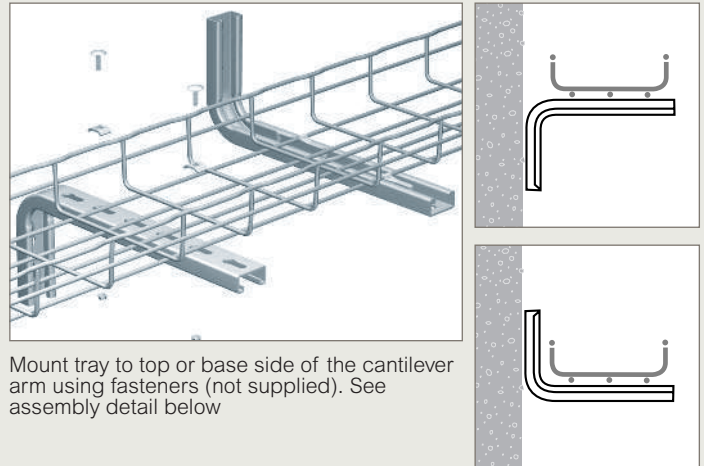

Mount tray to top or base side of the cantilever arm using fasteners (not supplied). See assembly detail below

■ **Assembly**

Securing CC21S to steel wire cable tray

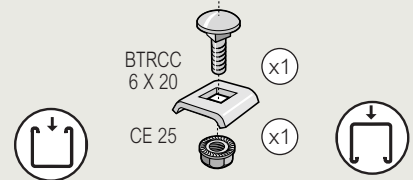
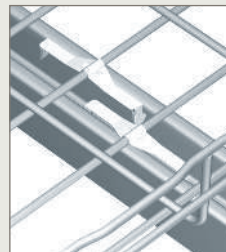

Secure to steel wire cable tray using FASTRUT 41 when grooved edge is facing upwards

Secure to steel wire cable tray using fasteners when flat surface is facing upwards

■ **Dimensions and weights**

↕ 30 → 105 mm ↔ 100 → 400 mm

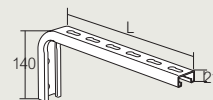

Cat. Nos.	L mm	F daN	Weight (kg)	
			GS	316L
CC21S150	150	135	0.33	0.36
CC21S200	200	108	0.39	0.42
CC21S300	300	80	0.46	0.50
CC21S400	400	92	0.55	0.59

Please use Cat. No. when placing your order, see p. 23

All weights are given in Kilograms (kg)

wall mounting – horizontal or vertical mounting

R15/25/35 – R55



■ R15/25/35 – stand-off brackets – couplers R55 – stand-off brackets

R15/25/35 - stand-off brackets

Use to fix 100 mm to 600 mm wide steel wire cable tray in 30 mm to 105 mm depths directly onto the wall. Can be used for horizontal and vertical mounting of cable tray runs. Can also be used for floor mounting (see p. 79) and as a base coupler (see p. 50). Incorporates slot and tab design for easy fixing. Supplied singly without fasteners

R55 - stand-off brackets

Use to fix 100 mm to 600 mm wide steel wire cable tray in 30 mm to 105 mm depths directly onto the wall. Can be used for horizontal and vertical mounting of cable tray runs. Can also be used for floor mounting (see p. 79). Incorporates slot and tab design for easy fixing. Supplied singly without fasteners

■ Installation

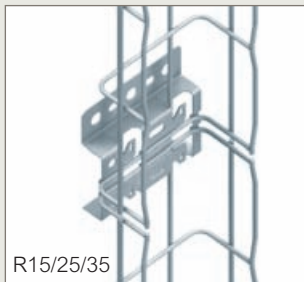

R15/25/35

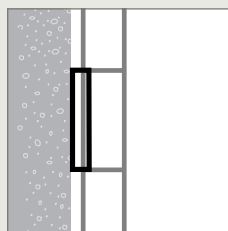

Mount directly onto wall using fasteners (not supplied). Vertical mounting of tray shown - horizontal mounting also possible



R55

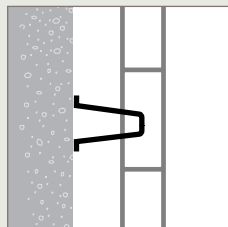

Mount directly onto wall using fasteners (not supplied). Vertical mounting of tray shown - horizontal mounting also possible

■ Assembly

Securing R15/25/35/55 to steel wire cable tray



FAS
FAST ASSEMBLING SYSTEM

Slot base wires of the tray into the cantilever arm and bend tabs with screwdriver to secure, as shown in the FAS diagram



Fast assembling



Fixing without nuts and bolts

NOTE :

200 to 300 mm wide tray requires 2 x brackets mounted side by side across the width of the tray. 400 to 600 mm wide tray requires 3 x brackets

→ For base coupling : see p. 50

→ For floor mounting : see p. 79

■ Dimensions and weights

R15/25/35 $\downarrow \uparrow$ 30 → 105 mm $\leftarrow \rightarrow$ 100 → 600 mm

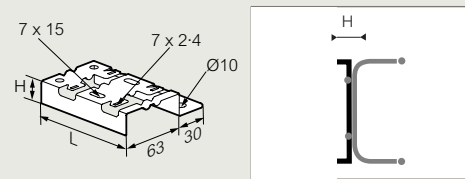

Cat. No.	H mm	L mm	F daN	Weight (kg)		
				GS	Z+	316L
R15/100	15	98	100	0.14	0.09	0.09
R15/300	15	300	100	0.38	0.41	–
R25	25	98	100	0.13	0.12	–
R35	35	98	50	0.15	0.14	–

Please use Cat. No. when placing your order, see p. 23

All weights are given in Kilograms (kg)

R55 $\downarrow \uparrow$ 30 → 105 mm $\leftarrow \rightarrow$ 100 → 600 mm

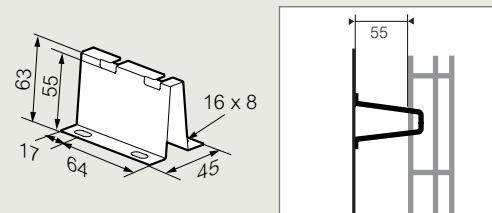

Cat. No.	H mm	F daN	Weight (kg)		
			GS	Z+	316L
R55	55	45	0.12	0.12	0.12

Please use Cat. No. when placing your order, see p. 23

All weights are given in Kilograms (kg)

Key : **GS** Pre-galvanised **316L** Stainless steel 316L

Z+ Continuous galvanisation before manufacture

For detailed information related to finishes, refer to p. 116-117

All dimensions (mm) are nominal

wall mounting – vertical mounting

FV1



■ FV1 – mounting bracket

Use to fix 100 mm to 600 mm wide steel wire cable tray in 30 mm to 105 mm depths directly onto the wall. Can be used for vertical mounting of cable tray runs. Incorporates slot and tab design for easy fixing. Supplied singly without fasteners

■ Installation

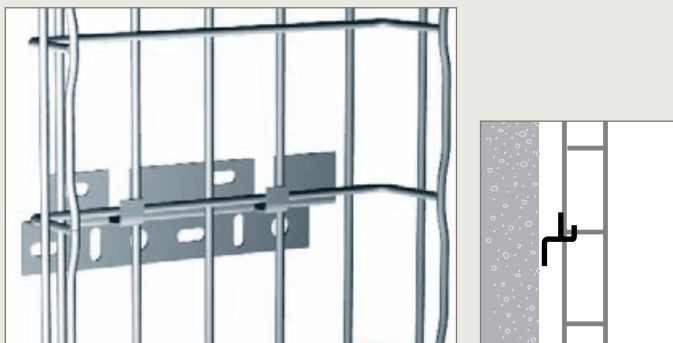

Mount directly onto wall using fasteners (not supplied)

■ Assembly

Securing FV1 to steel wire cable tray

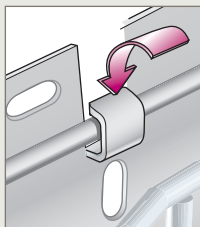

Fast assembling



Fixing without nuts and bolts

Bend tabs with screwdriver or pliers to secure FV1 to base of tray

■ Dimensions and weights

↑↓ 30 → 105 mm ↔ 100 → 600 mm

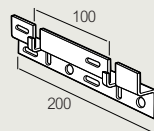

Cat. No.	↓ daN	Weight (kg)		
		GS	DC	316L
FV1	100	0.31	0.31	0.25

Please use Cat. No. when placing your order, see p. 23

All weights are given in Kilograms (kg)

Key :	GS Pre-galvanised	316L Stainless steel 316L
	DC Geomet	

For detailed information related to finishes, refer to **p. 116-117**

All dimensions (mm) are nominal

wall mounting – horizontal or vertical mounting

RCSN



■ RCSN – fast fix support rails

Use to fix 100 mm to 600 mm wide steel wire cable tray in 30 mm to 105 mm depths directly onto the wall. Can be used for horizontal and vertical mounting of cable tray runs. Can also be used for ceiling mounting (see. p. 71) and for floor mounting (see p. 78, 82) Incorporates slot and tab design for easy fixing. Supplied singly without fasteners

■ Installation

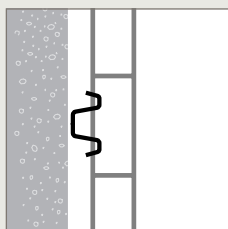
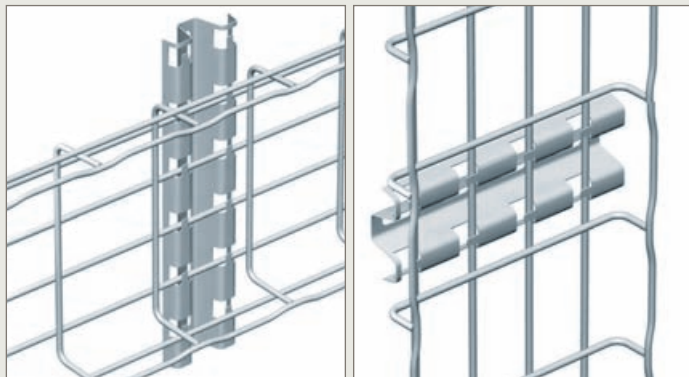

Mount directly onto wall using fasteners (not supplied) to run tray in a vertical or horizontal direction

■ Assembly



FAS
FAST ASSEMBLING SYSTEM

Slot base wires of the tray into the support rail and bend tabs with screwdriver to secure, as shown in the FAS diagram above

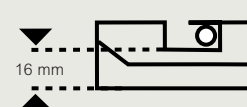

16 mm spacing from underside of base wire to wall

■ Dimensions and weights

↑↓ 30 → 105 mm ↔ 100 → 600 mm

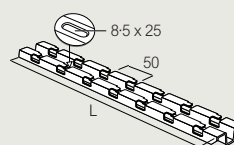

Cat. Nos.	L mm	↓F daN	Weight (kg)			
			GS	GC	304L	316L
RCSN150	150	100	0.16	0.17	–	0.16
RCSN200	200	100	0.23	0.23	–	0.22
RCSN300	300	100	0.33	0.36	–	0.33
RCSN400	400	100	0.38	0.49	–	0.45
RCSN500	500	100	0.54	0.61	–	0.59
RCSN550	550	100	0.63	0.65	–	–
RCSN600	600	100	0.67	0.70	–	0.69
RCSN1000	1 000	100	1.18	1.23	–	1.21
RCSN2000	2 000	100	2.20	2.42	2.30	2.30
RCSN3000	3 000	100	3.54	3.78	3.65	3.65

Please use Cat. No. when placing your order, see p. 24

All weights are given in Kilograms (kg)

→ For ceiling mounting : see p. 71

→ For floor mounting : see p. 78, 82

Key : **GS** Pre-galvanised **304L** Stainless steel 304L
GC Hot dip galvanised after manufacture **316L** Stainless steel 316L

For detailed information related to finishes, refer to p. 116-117

All dimensions (mm) are nominal

ceiling mounting – central hangers

SF50 – SF100 – SL50

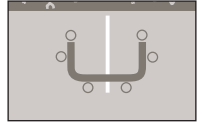

■ SF50 – SF100 – central hangers

Used with threaded rod and fasteners to form a central hanger to suspend steel wire cable tray from ceiling. Can also be bolted directly to the ceiling

Use SF50 for 50 mm wide steel wire cable tray in 30 mm and 54 mm depths and SF100 for 100mm wide tray in 30 mm and 54 mm depths
Incorporates slot and tab design for easy fixing
Supplied singly without fasteners

■ Installation

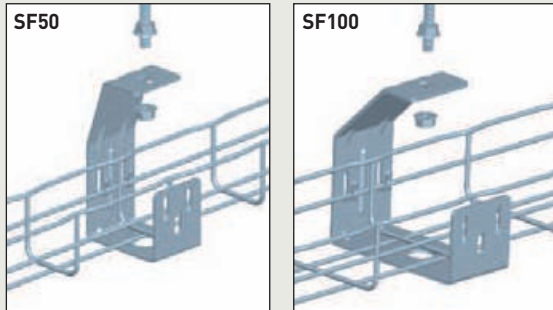

SF50 and SF100 used to suspend tray from ceiling with threaded rod and fasteners (not supplied). Provision of base hole enables easy access for installation

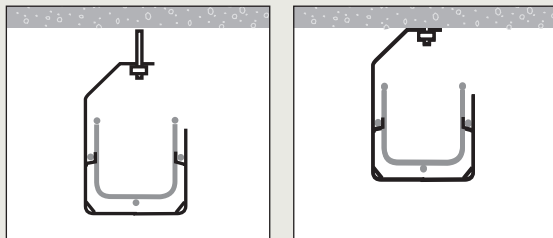

Suspended with threaded rod and fasteners (not supplied)

Bolted directly to ceiling. Fasteners not supplied

■ Assembly

Suspending SF50 / SF100 from ceiling



Securing SF50 / SF100 to steel wire cable tray

Side wires of the tray fix into bracket tabs. No additional fixings required to secure tray to bracket



Fast assembling



Fixing without nuts and bolts

Key : GS Pre-galvanised 316L Stainless steel 316L
GC Hot dip galvanised after manufacture

For detailed information related to finishes, refer to **p. 116-117**

All dimensions (mm) are nominal

■ Dimensions and weights

SF50

↕ 30 → 54 mm ↔ 50 mm

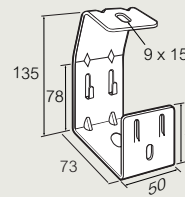

SF100

↕ 30 → 54 mm ↔ 100 mm

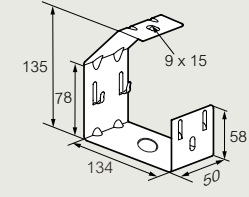

Cat. Nos.	L mm	F daN	Weight (kg)		
			GS	GC	316L
SF50	73	30	0.22	0.24	0.22
SF100	134	26	0.49	0.70	0.49

Please use Cat. No. when placing your order, see p. 25

All weights are given in Kilograms (kg)

■ SL50 – multifix base plate

Use as a central hanger to suspend 50 mm wide steel wire cable tray
Supplied singly. Threaded rod and fasteners not supplied

■ Installation and assembly

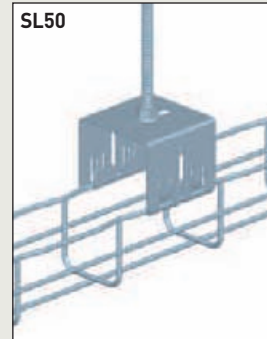

SL50 clips onto the side rail of the tray. No fasteners required to secure bracket to tray

■ Dimensions and weights

SL 50

↕ 30 → 54 mm ↔ 50 mm

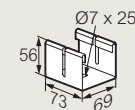

Cat. No.	H mm	F daN	Weight (kg)
			GS
SL50	56	150	0.19

Please use Cat. No. when placing your order, see p. 25

All weights are given in Kilograms (kg)

ceiling mounting – central hangers

CEQ – UC50

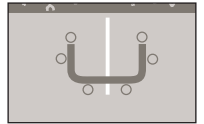

■ CEQ – central hanger brackets + UC50 – support cradles

CEQ - central hanger brackets

Use with UC50, threaded rod and fasteners to form a central hanger to suspend 50 mm wide steel wire cable tray in 30 mm and 54 mm depths from the ceiling
Supplied singly without fasteners

UC50 - support cradles

Use as a support cradle for 50 mm wide steel wire cable tray in 30 mm or 54 mm depths
Can be ceiling mounted in conjunction with CEQ or floor mounted (see p. 80).
Can also be mounted directly onto the wall - horizontally or vertically, or onto 41 mm channel profiles (see p. 52)
Supplied singly without fasteners

■ Installation

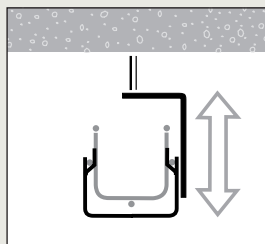
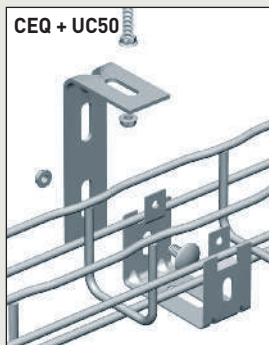

CEQ + UC50 used to suspend tray from ceiling with threaded rod and fasteners (not supplied)

Slot alignment allows for onsite adjustment

■ Assembly

Suspending CEQ + UC50 from ceiling

Securing UC50 to CEQ

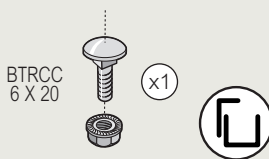
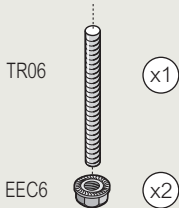

Use TR06 (M6 x 3m) threaded rod and 2 x EEC6 (6mm) hex nuts (not supplied) to suspend CEQ from ceiling

Use 1 x BTRCC (not supplied) to attach UC50 to CEQ, as shown in the side view illustration

Securing UC50 to steel wire cable tray

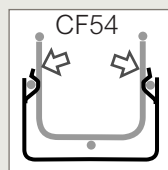
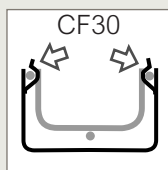
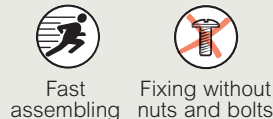
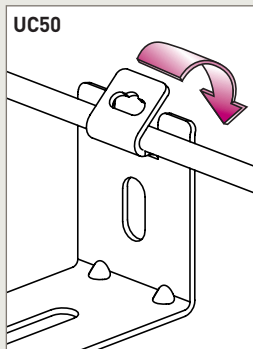

Bend tabs with screwdriver or pliers to secure UC50 to side rail of tray

→ For wall mounting : see p. 52

→ For floor mounting : see p. 80

■ Dimensions and weights

↑↓ 30 → 54 mm ↔ 50 mm

CEQ

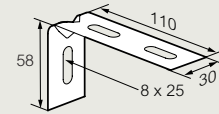

UC50

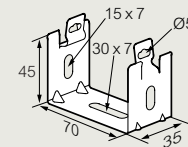

Cat. Nos.	F daN	Weight (kg)			
		GS	GC	304L	316L
CEQ	12	0-08	0-08	-	0-08
UC50	12	0-06	0-07	0-06	0-06

Please use Cat. No. when placing your order, see p. 25

All weights are given in Kilograms (kg)

Key :	GS	Pre-galvanised	304L	Stainless steel 304L
	GC	Hot dip galvanised after manufacture	316L	Stainless steel 316L

For detailed information related to finishes, refer to p. 116-117

All dimensions (mm) are nominal

ceiling mounting – central hangers

SAS

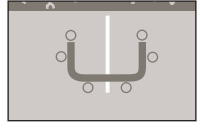

■ SAS – suspension hangers

Use with threaded rod and fasteners to form a central hanger to suspend 100 mm and 150 mm wide steel wire cable tray in 30 mm and 54 mm depths from the ceiling
 Incorporates slot and tab design for easy fixing
 Supplied singly without fasteners

■ Installation

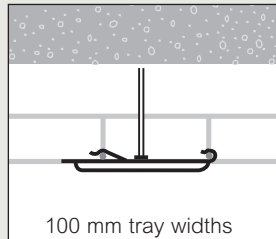
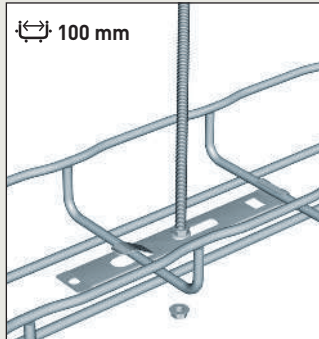

Mount SAS along the length of the tray when using 100 mm wide steel wire cable tray
 Use with threaded rod and fasteners (not supplied)

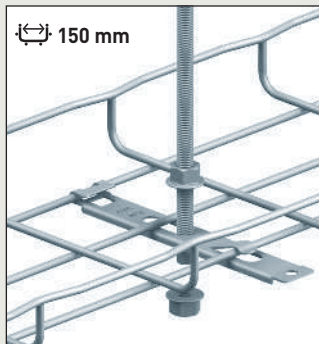

Mount SAS across the width of the tray when using 150 mm wide steel wire cable tray. Use with threaded rod and fasteners (not supplied)

Note :
 The threaded rod will sit off centre due to the position of the base wire in the tray length

■ Assembly

Suspending SAS from ceiling

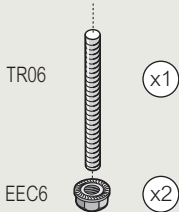

Use TR06 (M6 x 3m) threaded rod and 2 x EEC6 (6mm) hex nuts (not supplied) to suspend SAS from ceiling

Securing SAS to steel wire cable tray

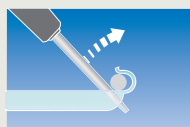

Fast assembling



Fixing without nuts and bolts

Base wires of the tray fix into hanger tabs. No additional fixings required to secure tray to SAS hanger
 Use blade of screwdriver to click SAS firmly into place

■ Dimensions and weights

Height: 30 → 54 mm Length: 100 → 150 mm

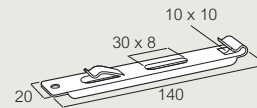

Cat. No.	↓ daN	Weight (kg)	
		EZ	DC
SAS	60	0-03	0-03

Please use Cat. No. when placing your order, see p. 25

All weights are given in Kilograms (kg)

Key :

EZ	Electrogalvanising after manufacture
DC	Geomet

For detailed information related to finishes, refer to **p. 116-117**

All dimensions (mm) are nominal

ceiling mounting – central hangers

CE40 – CM50XL

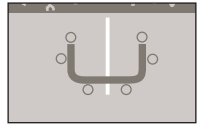

■ CE40 – hold down clamps (used as hangers)

Use in a pair with threaded rod and fasteners to form a central hanger to suspend 100 mm to 200 mm wide steel wire cable tray in 30 mm and 54 mm depths from the ceiling
Supplied in packs of 25 without fasteners

■ Installation

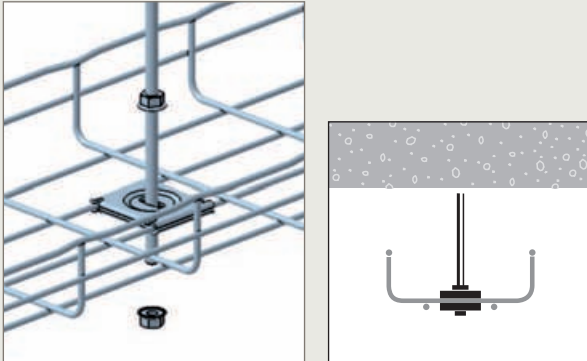

CE40 used to suspend tray from ceiling with threaded rod and fasteners (not supplied)

■ Assembly

Suspending CE40 from ceiling

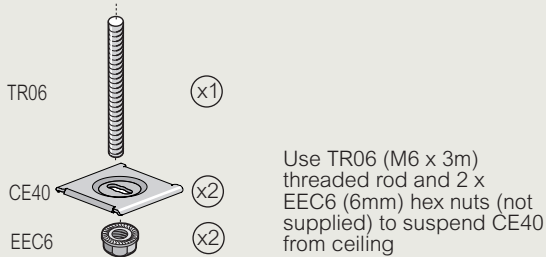

Securing CE40 to steel wire cable tray

Use 2 x CE40, one on the top side and one to the underside of the tray. Secure with 2 x EEC6 hex nuts, as shown above

■ Dimensions and weights

30 → 54 mm 100 → 200 mm

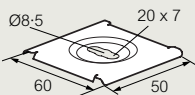

Cat. No.	↓ daN	Weight (kg)			
		EZ	DC	304L	316L
CE40	100	0.04	0.04	0.04	0.04

Please use Cat. No. when placing your order, see p. 25

All weights are given in Kilograms (kg)

Key :	EZ Electrogalvanising after manufacture	304L Stainless steel 304L
	DC Geomet	316L Stainless steel 316L
	GS Pre-galvanised	

For detailed information related to finishes, refer to p. 116-117

→ To create radius bends : see p. 99-103

■ CM50XL – universal mounting plates (large)

Use with threaded rod and fasteners to form a central hanger to suspend 100 mm to 200 mm wide steel wire cable tray in 30 mm and 54 mm depths from the ceiling
Can also be used for horizontal and vertical wall mounting of cable tray runs (see p. 55) and for floor mounting (see p. 78)
Incorporates slot and tab design for easy fixing. Supplied singly without fasteners

■ Installation

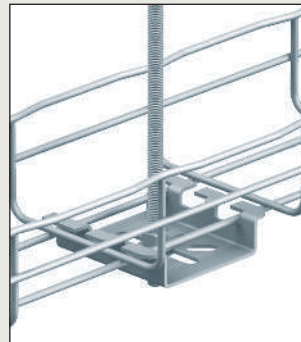

CM50XL used to suspend tray from ceiling with threaded rod and fasteners (not supplied)

■ Assembly

Suspending CM50XL from ceiling

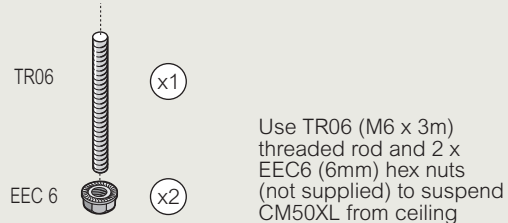

Securing CM50XL to steel wire cable tray

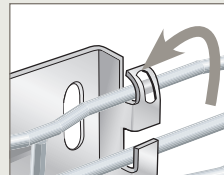

Bend tabs using a flat blade screwdriver or pair of pliers to secure to steel wire cable tray



Fast assembling



Fixing without nuts and bolts

■ Dimensions and weights

30 → 54 mm 100 → 200 mm

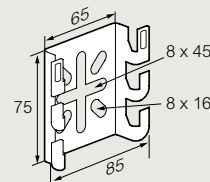

Cat. No.	↓ daN	Weight (kg)			
		GS	GC	304L	316L
CM50XL	100	0.10	0.11	0.08	0.08

Please use Cat. No. when placing your order, see p. 25

All weights are given in Kilograms (kg)

All dimensions (mm) are nominal

→ For wall mounting : see p. 55

→ For floor mounting : see p. 78

ceiling mounting – central hangers

SCF – PFSCF – EXT-SCF

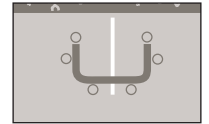

■ SCF – central hangers + PFSCF – locating ceiling plate + EXT-SCF – rod sheaths

SCF - central hangers

Use with threaded rod and fasteners to form a central hanger to suspend 200 mm to 600 mm wide steel wire cable tray in 30 mm and 54 mm depths from the ceiling. Incorporates slot and tab design for easy fixing. Used in conjunction with PFSCF locating ceiling plate and EXT-SCF rod sheath. Supplied singly without fasteners

PFSCF - locating ceiling plate

Locating plate for use with SCF. Supplied singly without fasteners

EXT-SCF - rod sheaths

Extension rod sheath for use with SCF. EXT-SCF helps to protect cables from damage. Supplied singly without fasteners

■ Installation

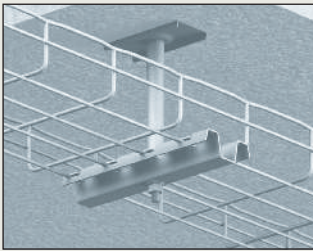

SCF central hanger in situ with PFSCF locating ceiling plate and EXT-SCF rod sheath covering threaded rod

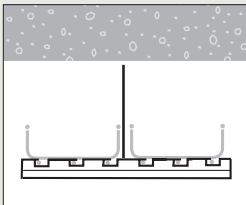

SCF can support 2 x tray runs up to 200 mm wide side by side

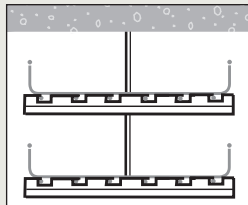

2 x SCF can be used in a tier arrangement

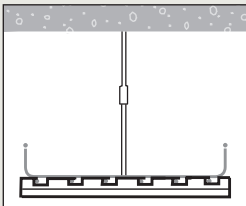

EXT-SCF can be used with threaded rod of any length

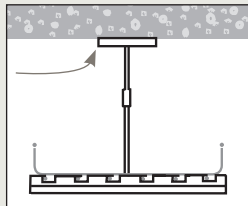

PFSCF can be used to spread the load and further stabilise the installation

■ Assembly

Suspending SCF from ceiling

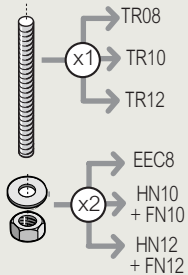

Installation steps

- 1) Install threaded rod into ceiling fixing, such as ceiling anchor (not supplied)
- 2) On floor level, assemble wire mesh onto SCF
- 3) Attach EXT-SCF rod sheath and PFSCF locating ceiling plate to SCF central hanger
- 4) Offer assembly up to pre-fitted threaded rod
- 5) Secure assembly with washers and hexagon nuts

■ Assembly (continued)

Securing SCF to steel wire cable tray



Slot base wires of the tray into the SCF hanger and bend tabs with screwdriver to secure, as shown in the FAS diagram



Fast assembling



Fixing without nuts and bolts

■ Dimensions and weights

SCF - \downarrow 30 \rightarrow 54 mm \leftrightarrow 200 \rightarrow 600 mm

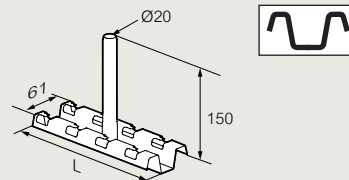

Cat. Nos.	L mm	Load Capacity		Weight (kg) GS
		FL daN	JL daN	
SCF200	194	200	37	0.27
SCF300	294	160	29	0.39
SCF400	394	141	23	0.51
SCF450	444	130	20	0.57
SCF500	494	121	20	0.64
SCF600	594	99	19	0.78

Please use Cat. No. when placing your order, see p. 26

All weights are given in Kilograms (kg)

PFSCF - \downarrow 30 \rightarrow 54 mm \leftrightarrow 200 \rightarrow 600 mm

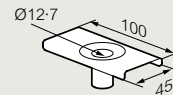

Cat. No.	L mm	Weight (kg) GS

EXT-SCF - \downarrow 30 \rightarrow 54 mm \leftrightarrow 200 \rightarrow 600 mm

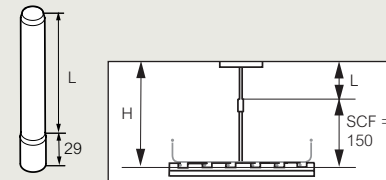

Cat. Nos.	L mm	H mm	Weight (kg) GS
EXT-SCF100	100	250	0.11
EXT-SCF150	150	300	0.12
EXT-SCF325	325	475	0.20

Please use Cat. No. when placing your order, see p. 26

All weights are given in Kilograms (kg)

Key : GS Pre-galvanised

For detailed information related to finishes, refer to **p. 116-117**

All dimensions (mm) are nominal

ceiling mounting – central hangers

UCS – RCSN

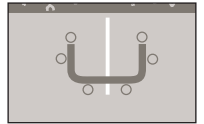

■ UCS – ceiling support brackets + RCSN – fast fix support rails

UCS - ceiling support brackets

Use with RCSN or channel to form a central hanger to suspend 2 parallel runs of 50 mm (100 mm using RCSN) to 300 mm wide steel wire cable tray in 30 mm and 54 mm depths from the ceiling. Supplied singly without fasteners

RCSN - fast fix support rails

Use with UCS (above) or threaded rod to form a central hanger to suspend steel wire cable tray from the ceiling. Can also be used for horizontal and vertical wall mounting of cable tray runs (see p. 65) and for floor mounting (see p. 78). Incorporates slot and tab design for easy fixing. Supplied singly without fasteners

■ Installation

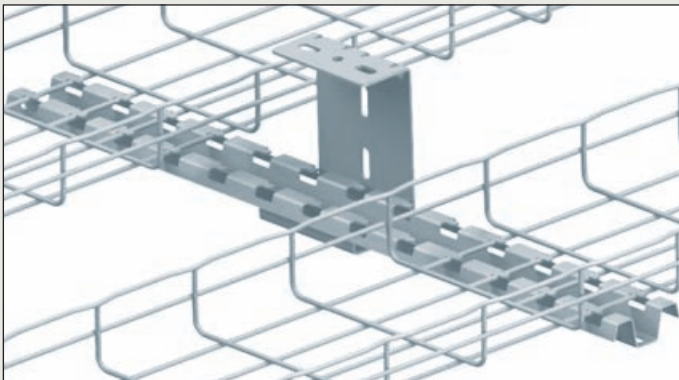

UCS ceiling support bracket + RCSN fast fix support rail to support 2 x parallel runs of steel wire cable tray from the ceiling

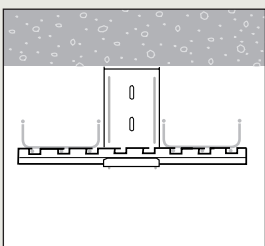

UCS and RCSN supporting parallel runs of cable tray

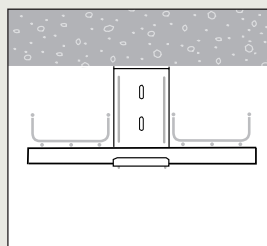

UCS and channel supporting parallel runs of cable tray

■ Assembly

Suspending UCS + RCSN from ceiling

BTRL 8 x 15

Use BTRL 8 x 15 fasteners to secure RCSN support rail or channel support to UCS

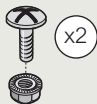

Securing RCSN to steel wire cable tray



Slot base wires of the tray into the RCSN support rail and bend tabs with screwdriver to secure, as shown in the FAS diagram above



Fast assembling



Fixing without nuts and bolts

→ For wall mounting : see p. 65

→ For floor mounting : see p. 78

■ Assembly (continued)

Securing channel support to steel wire cable tray



Use FASTRUT 41 (see p. 18) to secure steel wire cable tray to channel lengths

■ Dimensions and weights

UCS - $\downarrow \uparrow$ 30 → 54 mm \curvearrowright 50 → 300 mm

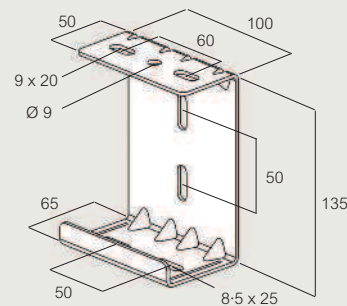

Cat. Nos.	L mm	daN.m	Weight (kg)		
			GS	GC	316L
UCS	100	18	0.51	0.51	0.51

Please use Cat. No. when placing your order, see p. 26

All weights are given in Kilograms (kg)

RCSN - $\downarrow \uparrow$ 30 → 105 mm \curvearrowright 100 → 600 mm

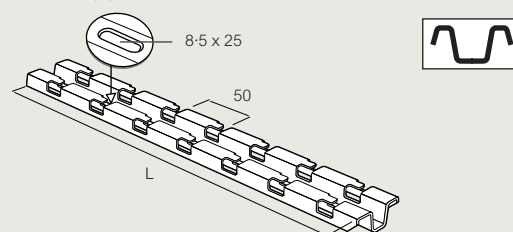

Cat. No.	L mm	Weight (kg)			
		GS	GC	304L	316L
RCSN150	150	0.16	0.17	-	0.16
RCSN200	200	0.23	0.23	-	0.22
RCSN300	300	0.33	0.36	-	0.33
RCSN400	400	0.38	0.49	-	0.45
RCSN500	500	0.54	0.61	-	0.59
RCSN550	550	0.63	0.65	-	-
RCSN600	600	0.67	0.70	-	0.69
RCSN1000	1000	1.18	1.23	-	1.21
RCSN2000	2000	2.20	2.42	2.30	2.30
RCSN3000	3000	3.54	3.78	3.65	3.65

Please use Cat. No. when placing your order, see p. 27

All weights are given in Kilograms (kg)

Key :	GS Pre-galvanised	304L Stainless steel 304L
	GC Hot dip galvanised after manufacture	316L Stainless steel 316L
	For detailed information related to finishes, refer to p. 116-117	

All dimensions (mm) are nominal

ceiling mounting – trapeze

AS

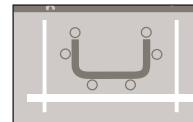

■ AS – suspension hooks

Use with threaded rod and fasteners to form a trapeze hanger to suspend 100 mm to 600 mm wide steel wire cable tray in 30 mm to 105 mm depths from the ceiling. Supplied singly without fasteners

■ Installation

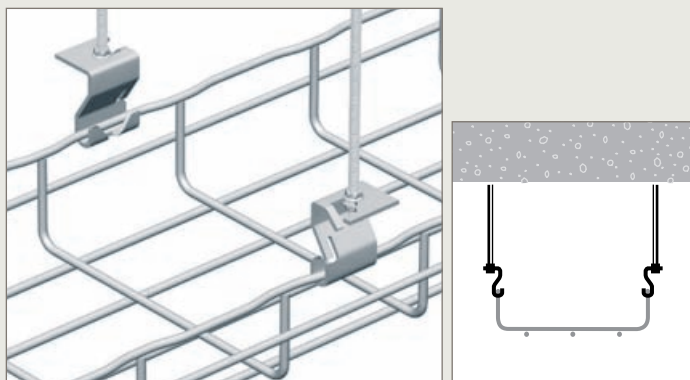

AS suspension hook suspending wire tray from the ceiling with threaded rod and fasteners (not supplied)

■ Assembly

Suspending AS from ceiling

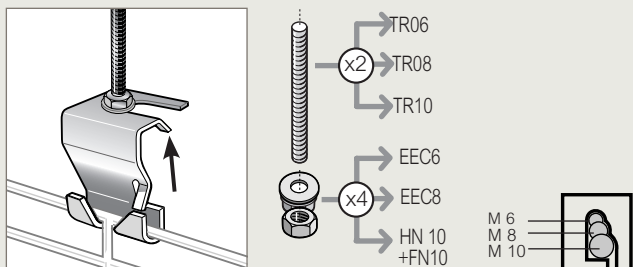

Bend tab upwards to lock threaded rod into place

Use TR06 / 08 or 10 (M6 / M8 / M10 x 3m) threaded rod and 4 x EEC6 / 8 or 10 (6 / 8 or 10mm) hex nuts (not supplied) to suspend AS from ceiling

Securing AS to steel wire cable tray

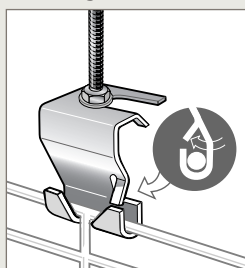

Bend tab upwards to lock side bar of tray into place



Fast assembling



Fixing without nuts and bolts

■ Dimensions and weights

↓ 30 → 105 mm ↔ 100 → 600 mm

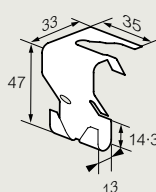

Cat. Nos.	↓ daN	Weight (kg)		
		GS	DC	316L
AS	100	0-04	0-05	0-04

Please use Cat. No. when placing your order, see p. 26

All weights are given in Kilograms (kg)

Key : **GS** Pre-galvanised

316L Stainless steel 316L

DC Geomet

For detailed information related to finishes, refer to **p. 116-117**

All dimensions (mm) are nominal

ceiling mounting – profile CSNC

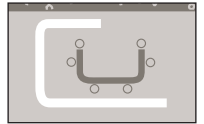

■ CSNC – profile roof cantilever arms

Use to support 100 mm to 450 mm wide steel wire cable tray in 30 mm to 105 mm depths. Can be mounted directly to the ceiling using fasteners (not supplied) to form a pendant drop or can be wall mounted (see p. 57). Incorporates slot and tab design for easy fixing. Supplied singly without fasteners.

■ Installation



Mount directly onto ceiling using fasteners (not supplied).

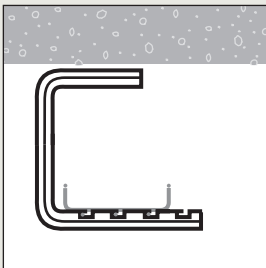

Support single runs of steel wire cable tray using one ceiling mounted cantilever arm

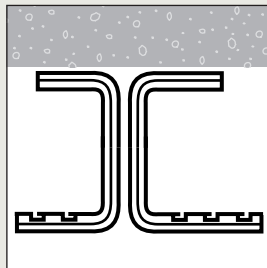

Mount cantilever arms back to back to run two horizontal runs of steel wire cable tray

■ Assembly

Securing CSNC cantilever arm to steel wire cable tray



FAS
FAST ASSEMBLING SYSTEM

Slot base wires of the tray into the cantilever arm and bend tabs with screwdriver to secure, as shown in the FAS diagram above



Patented



Fast assembling



Fixing without nuts and bolts

■ Dimensions and weights

↓ 30 → 105 mm ↶ 100 → 450 mm

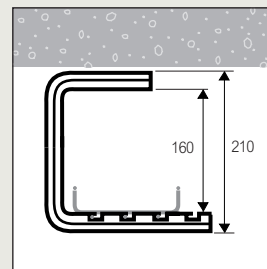
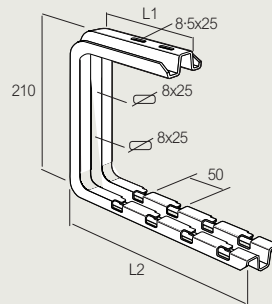

Cat. Nos.	L1 mm	L2 mm	↓ daN	Weight (kg)		
				GS	GC	316L
CSNC100	170	178	120	0.57	0.65	0.60
CSNC150	170	228	100	0.63	0.72	0.67
CSNC200	170	278	80	0.68	0.80	0.72
CSNC300	288	378	70	1.30	1.35	–
CSNC400	288	478	48	1.36	1.38	–
CSNC450	288	528	44	1.40	1.47	–

Please use Cat. No. when placing your order, see p. 26

All weights are given in Kilograms (kg)

Key : **GS** Pre-galvanised **316L** Stainless steel 316L
GC Hot dip galvanised after manufacture

For detailed information related to finishes, refer to p. 116-117

All dimensions (mm) are nominal

→ For wall mounting : see p. 57

ceiling mounting – trapeze

RCSN

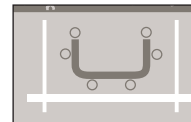

■ RCSN – fast fix support rails

Use with threaded rod and fasteners to form a trapeze hanger to suspend 100 mm to 600 mm wide steel wire cable tray in 30 mm to 105 mm depths from the ceiling.
Can be mounted directly onto the wall (see p. 65) or floor mounted (see p. 78).
Incorporates slot and tab design for easy fixing. Supplied singly without fasteners.

■ Installation

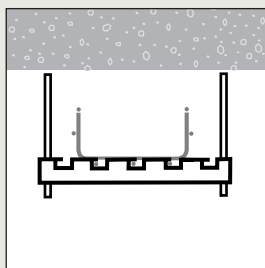
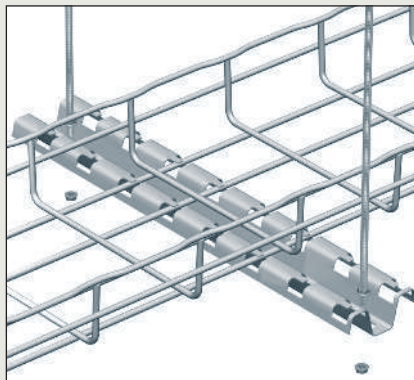

RCSN support rails suspending wire tray from the ceiling with threaded rod and fasteners (not supplied)

■ Assembly

Suspending RCSN from ceiling

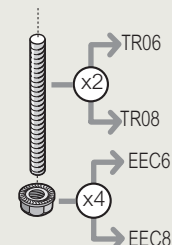

Use 2 x TR06 or TR08 (M6 / M8 x 3m) threaded rod and 4 x EEC6 or EEC8 (6 or 8mm) hex nuts (not supplied) to suspend RCSN from ceiling

Securing RCSN support rail to steel wire cable tray



FAS
FAST ASSEMBLING SYSTEM

Slot base wires of the tray into the cantilever arm and bend tabs with screwdriver to secure, as shown in the FAS diagram above



Patented



Fast assembling



Fixing without nuts and bolts

■ Dimensions and weights

↓↑: 30 → 105 mm ↔: 100 → 600 mm

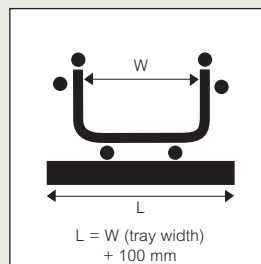
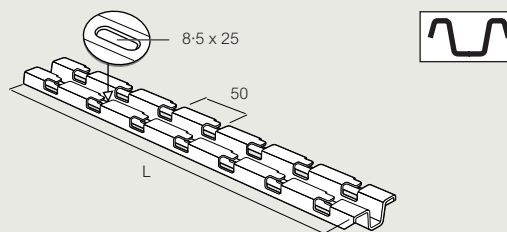

To select the correct size RCSN for trapeze hanging, add 100 mm to the chosen tray width to allow for fixing of threaded rod either side of the tray, e.g. if using 200 mm wide tray, use a 300 mm wide RCSN

Cat. No.	L mm	Weight (kg)			
		GS	GC	304L	316L
RCSN150	150	0.16	0.17	–	0.16
RCSN200	200	0.23	0.23	–	0.22
RCSN300	300	0.33	0.36	–	0.33
RCSN400	400	0.38	0.49	–	0.45
RCSN500	500	0.54	0.61	–	0.59
RCSN550	550	0.63	0.65	–	–
RCSN600	600	0.67	0.70	–	0.69
RCSN1000	1 000	1.18	1.23	–	1.21
RCSN2000	2 000	2.20	2.42	2.30	2.30
RCSN3000	3 000	3.54	3.78	3.65	3.65

Please use Cat. No. when placing your order, see p. 27

All weights are given in Kilograms (kg)

GS	Pre-galvanised	304L	Stainless steel 304L
GC	Hot dip galvanised after manufacture	316L	Stainless steel 316L

For detailed information related to finishes, refer to p. 116-117

All dimensions (mm) are nominal

→ For wall mounting : see p. 65

→ For floor mounting : see p. 78

ceiling mounting – trapeze

EDF

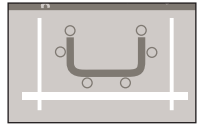

EDF – profile pendants / mounting rails

Use with threaded rod and fasteners to form a trapeze hanger to suspend 100 mm to 600 mm wide steel wire cable tray in 30 mm to 105 mm depths from the ceiling or use with PFREDF to form a pendant installation (opposite).

Can be mounted directly onto the wall for use with cantilever arms (see p. 58)

Supplied singly without fasteners

Installation

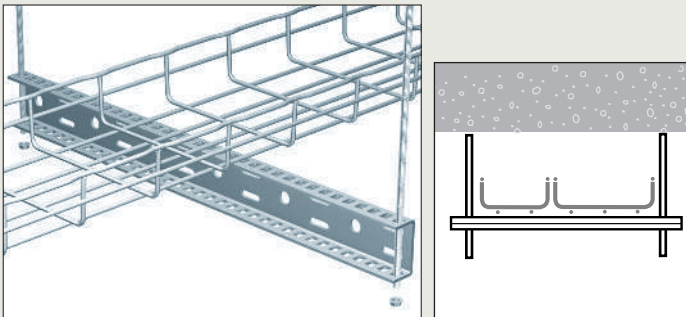

EDF mounting rails suspending wire tray from the ceiling with threaded rod and fasteners (not supplied)

Assembly

Suspending EDF from ceiling - trapeze mounting

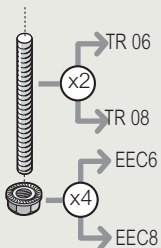

Use 2 x TR06 or TR08 (M6 / M8 x 3m) threaded rod and 4 x EEC6 or EEC8 (6 or 8mm diameter) hex nuts (not supplied) to suspend EDN from ceiling

Securing EDF mounting rail to steel wire cable tray

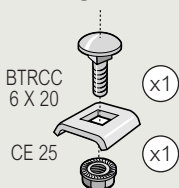

Use 1 x BTRCC 6 x 20 and 1 x CE25 to secure 50 mm to 200 mm tray EDF
For 300 mm to 600 mm tray use 2 x BTRCC 6 x 20 and 2 x CE25

Dimensions and weights

Height: 30 → 105 mm Length: 100 → 600 mm

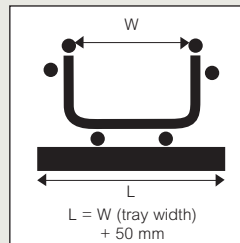
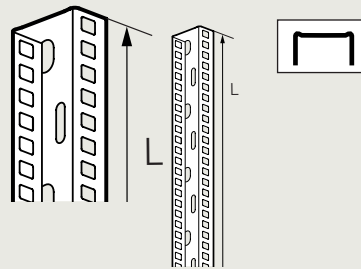

To cut the correct size EDF for trapeze hanging, add 50 mm to the chosen tray width to allow for fixing of threaded rod either side of the tray, e.g. if using 200 mm wide tray, cut EDF to 250 mm wide

Cat. No.	L mm	Weight (kg)			
		GS	GC	304L	316L
EDF2000	2000	2.40	2.56	2.48	2.48

Please use Cat. No. when placing your order, see p. 27

All weights are given in Kilograms (kg)

GS	Pre-galvanised	304L	Stainless steel 304L
GC	Hot dip galvanised after manufacture	316L	Stainless steel 316L

For detailed information related to finishes, refer to p. 116-117

All dimensions (mm) are nominal

→ For wall mounting : see p. 58

ceiling mounting – pendant

PFREDF

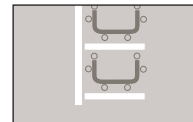

■ PFREDF – pendant mounting plates EDF – profile pendants / mounting rails

PFREDF

Use as a ceiling mounting plate in conjunction with EDF to form a pendant drop to suspend 100 mm to 600 mm wide steel wire cable tray in 30 mm to 105 mm depths from the ceiling via cantilever arms (see p. 56-62).

Incorporates slot and tab design for easy fixing of EDF
Supplied singly without fasteners

EDF

Use with threaded rod and fasteners to form a trapeze hanger to suspend 100 mm to 600 mm wide steel wire cable tray in 30 mm to 105 mm depths from the ceiling or use with PFREDF to form a pendant installation (opposite).

Can be mounted directly onto the wall for use with cantilever arms (see p. 58)

Supplied singly without fasteners

■ Installation

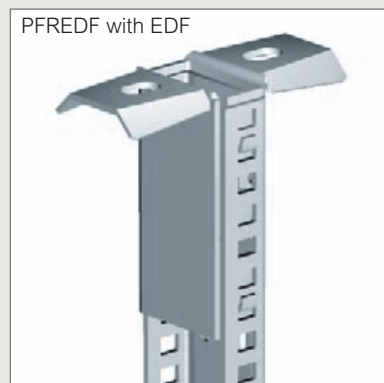

PFREDF pendant mounting plate with EDF mounting rail. Secure to ceiling using fasteners (not supplied)

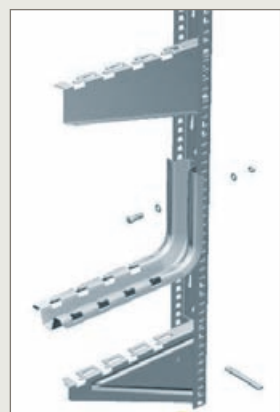

Cantilever arms can be mounted to one side of the EDF mounting rail. See p. 56-62

■ Assembly

Suspending EDF from ceiling - pendant mounting



Bend tabs to secure to PFREDF pendant mounting plate to EDF mounting rail.
No fasteners required



Fast assembling



Fixing without nuts and bolts

■ Dimensions and weights

↓ 30 → 105 mm ← 100 → 600 mm

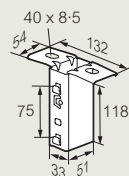

Cat. No.	daN.m	Weight (kg)	
		GS	316L
PFREDF	18	0.51	0.51

Please use Cat. No. when placing your order, see p. 27

All weights are given in Kilograms (kg)

Key :	GS Pre-galvanised	316L Stainless steel 316L
		For detailed information related to finishes, refer to p. 116-117

All dimensions (mm) are nominal

ceiling mounting – pendant

RE41SP – PFR41S

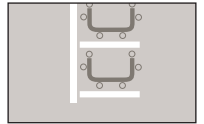

RE41SP – pendants / mounting rails (heavy duty) PFR41S – pendant mounting plates (heavy duty)

RE41SP

Use with PFR41S to form pendant drop to suspend 100 mm to 600 mm wide steel wire cable tray in 30 mm to 105 mm depths from the ceiling. Supplied singly without fasteners.

PFR41S

Use as a ceiling mounting plate in conjunction with EDF to form a pendant drop to suspend 100 mm to 600 mm wide steel wire cable tray in 30 mm to 105 mm depths from the ceiling via cantilever arms (see p. 56-62).

Incorporates slot and tab design for easy fixing of EDF. Supplied singly without fasteners.

Installation

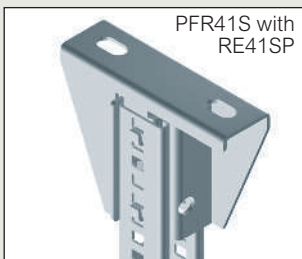

PFR41S pendant mounting plate with RE41SP mounting rail. Secure to ceiling using fasteners (not supplied).

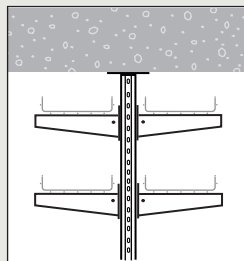
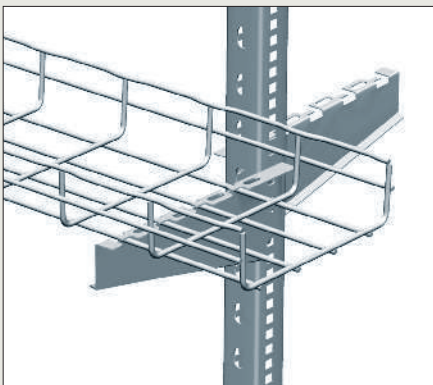

Cantilever arms can be mounted to both sides of the RE41SP mounting rail. Fast fit CG cantilever arms shown (see p. 56-62 for full range).

Assembly

Suspending RE41SP from ceiling - pendant mounting



FAST
FAST ASSEMBLING SYSTEM



Bend tabs to secure PFR41S pendant mounting plate to RE41SP mounting rail. No fasteners required.



Fast assembling



Fixing without nuts and bolts

Dimensions and weights

RE41SP \downarrow 30 → 105 mm \rightarrow 100 → 600 mm

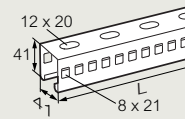

Cat. Nos.	L mm	mm	Weight (kg) GS
RE41SP500	500	2	1.30
RE41SP800	800	2	1.90
RE41SP1000	1 000	2	2.60
RE41SP3000	3 000	2	7.90

Please use Cat. No. when placing your order, see p. 27

All weights are given in Kilograms (kg)

PFR41S

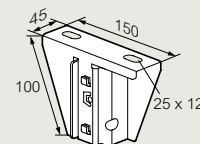

Patented

Cat. Nos.	daN.m	Weight (kg) GS
PFR41S	45	0.69

Please use Cat. No. when placing your order, see p. 27

All weights are given in Kilograms (kg)

Key : Pre-galvanised

For detailed information related to finishes, refer to p. 116-117

All dimensions (mm) are nominal

floor mounting
CM50XL – RCSN

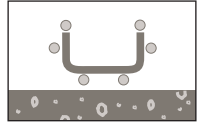

■ **CM50XL – universal mounting plates (large)**

Use to fix 100 mm to 600 mm wide steel wire cable tray in 30 mm to 150 mm depths directly to the floor
 For 200 mm and 300 mm wide tray, use 2 x CM50XL per length
 For 400 mm to 600 mm wide tray, use 3 x CM50XL per length
 Can also be used for wall mounting (see p. 55) and to suspend cable tray runs from the ceiling (see p. 69)
 Incorporate slot and tab design for easy fixing. Supplied singly without fasteners

■ **Installation**

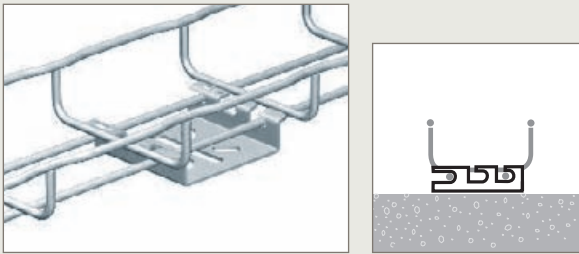

Mount tray runs on the floor using CM50XL and fasteners (not supplied)

■ **Assembly**

Securing CM50XL to steel wire cable tray

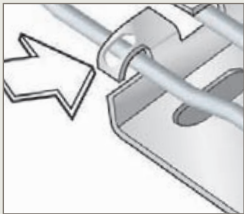

Bend tabs with pliers or screwdriver to secure to steel wire cable tray



Fast assembling



Fixing without nuts and bolts

■ **Dimensions and weights**

↕ 30 → 150 mm ↔ 100 → 600 mm

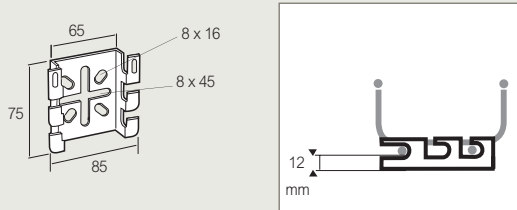

Cat. No.	↓ daN	Weight (kg)			
		GS	GC	304L	316L
CM50XL	100	0-10	0-11	0-08	0-08

Please use Cat. No. when placing your order, see p. 28
 All weights are given in Kilograms (kg)

■ **RCSN – fast fix support rails**

Use to fix 100 mm to 600 mm wide steel wire cable tray in 30 mm to 150 mm depths directly to the floor
 Can also be used for wall mounting (see p. 65) and to suspend cable tray runs from the ceiling (see p. 71, 74)
 Incorporate slot and tab design for easy fixing. Supplied singly without fasteners

■ **Installation**

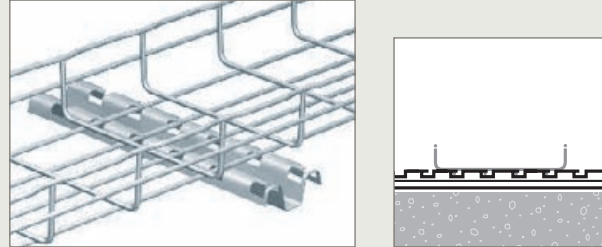

Mount tray runs on the floor using RCSN and fasteners (not supplied)

■ **Assembly**

Securing RCSN to steel wire cable tray



FAS
FAST ASSEMBLING SYSTEM



Patented



Fast assembling



Fixing without nuts and bolts

Slot base wires of the tray into the RCSN support rail and bend tabs with screwdriver to secure, as shown in the FAS diagram above

■ **Dimensions and weights**

↕ 30 → 150 mm ↔ 100 → 600 mm

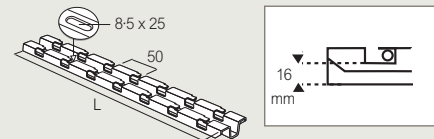

16 mm spacing from underside of base wire to floor

Cat. No.	L mm	Weight (kg)			
		GS	GC	304L	316L
RCSN150	150	0-16	0-17	–	0-16
RCSN200	200	0-23	0-23	–	0-22
RCSN300	300	0-33	0-36	–	0-33
RCSN400	400	0-38	0-49	–	0-45
RCSN500	500	0-54	0-61	–	0-59
RCSN550	550	0-63	0-65	–	–
RCSN600	600	0-67	0-70	–	0-69
RCSN1000	1 000	1-18	1-23	–	1-21
RCSN2000	2 000	2-20	2-42	2-30	2-30
RCSN3000	3 000	3-54	3-78	3-65	3-65

Please use Cat. No. when placing your order, see p. 28

All weights are given in Kilograms (kg)

Key :	GS Pre-galvanised	304L Stainless steel 304L
	GC Hot dip galvanised after manufacture	316L Stainless steel 316L
	For detailed information related to finishes, refer to p. 116-117	

All dimensions (mm) are nominal

→ For wall mounting : see p. 55, 65

→ For ceiling mounting : see p. 69, 71, 74

floor mounting

R15/25/35/300 – R55

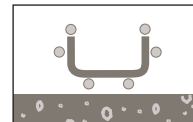

R15/25/35/300 – stand-off brackets R55 – stand-off brackets

R15/25/35/300 - stand-off brackets

Use to fix 100 mm to 600 mm wide steel wire cable tray in 30 mm to 150 mm depths directly onto the floor. For 200 mm and 300 mm wide tray, use 2 x brackets per length. For 400 mm to 600 mm wide tray, use 3 x brackets per length. Can also be used for wall mounting (see p. 63). Incorporate slot and tab design for easy fixing. Supplied singly without fasteners

R55 - stand-off brackets

Use to fix 100 mm to 600 mm wide steel wire cable tray in 30 mm to 80 mm depths directly onto the floor. For 200 mm and 300 mm wide tray, use 2 x brackets per length. For 400 mm to 600 mm wide tray, use 3 x brackets per length. Can also be used for wall mounting (see p. 63). Incorporate slot and tab design for easy fixing. Supplied singly without fasteners

Installation

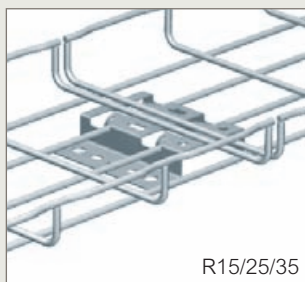

R15/25/35

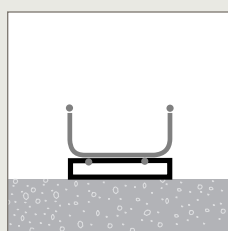

Mount tray runs on the floor using R15/25/35/300 and fasteners (not supplied)

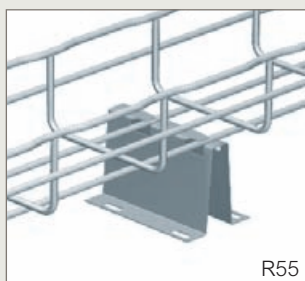

R55

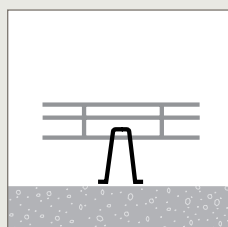

Mount tray runs on the floor using R55 and fasteners (not supplied)

Assembly

Securing stand-off brackets to steel wire cable tray



FAST
FAST ASSEMBLING SYSTEM



Patented



Fast assembling



Fixing without nuts and bolts

Slot base wires of the tray into the stand-off bracket and bend tabs with screwdriver to secure, as shown in the FAST diagram above

→ For wall mounting : see p. 63

→ For base coupling : see p. 50

Dimensions and weights

R15/25/35/300 \downarrow 30 → 105 mm \leftarrow 100 → 600 mm

R15/25/35/300

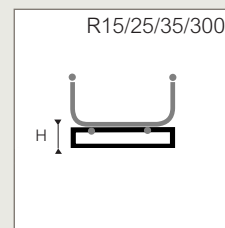
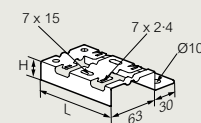

Cat. No.	H mm	L mm	F daN	Weight (kg)		
				GS	Z+	316L
R15/100	15	98	100	0.14	0.09	0.09
R15/300	15	300	100	0.38	0.41	–
R25	25	98	100	0.13	0.12	–
R35	35	98	50	0.15	0.14	–

Please use Cat. No. when placing your order, see p. 28

All weights are given in Kilograms (kg)

R55 \downarrow 30 → 150 mm \leftarrow 100 → 600 mm

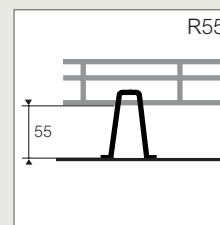
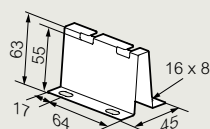

Cat. No.	H mm	F daN	Weight (kg)		
			GS	Z+	316L
R55	55	45	0.12	0.12	0.12

Please use Cat. No. when placing your order, see p. 28

All weights are given in Kilograms (kg)

Key : **GS** Pre-galvanised **316L** Stainless steel 316L

Z+ Continuous galvanisation before manufacture

For detailed information related to finishes, refer to p. 116-117

All dimensions (mm) are nominal

floor mounting
FTX – UC50

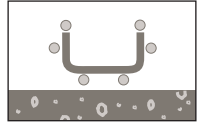

FTX – base fixing plates

Use to fix 35 mm to 600 mm wide steel wire cable tray in 30 mm to 105 mm depths directly onto the floor. For 200 mm and 300 mm wide tray, use 2 x brackets per length. For 400 mm to 600 mm wide tray, use 3 x brackets per length. Supplied singly without fasteners

Installation

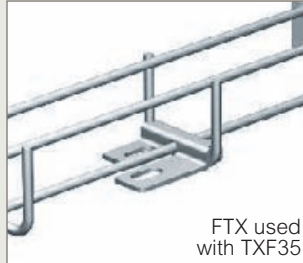
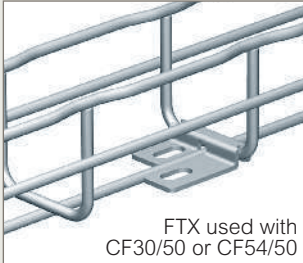

Attach FTX along the length of 50 mm wide tray and TXF35 tray. Secure to the floor using fasteners (not supplied)

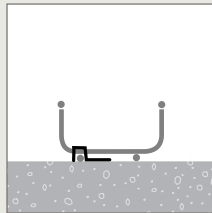
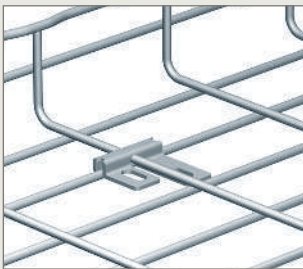

Attach FTX across the width of 100 mm to 600 mm wide tray. Secure to the floor using fasteners (not supplied)

Assembly

Securing stand-off brackets to steel wire cable tray



Click to secure to steel wire cable tray



Dimensions and weights

↓ 30/54/105 mm ← 35 → 600 mm

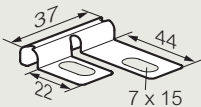

Cat. No.	Weight (kg)		
	GS	DC	316L
FTX	0-25	0-20	0-20

Please use Cat. No. when placing your order, see p. 29

All weights are given in Kilograms (kg)

Key :

GS Pre-galvanised	316L Stainless steel 316L
DC Geomet	

For detailed information related to finishes, refer to **p. 116-117**

All dimensions (mm) are nominal

UC50 – support cradles

Use as a support cradle for 50 mm wide steel wire cable tray in 30 mm or 54 mm depths. Can also be used for wall mounting (see p. 52) and to suspend cable tray runs from the ceiling (see p. 67). Supplied singly without fasteners

Installation

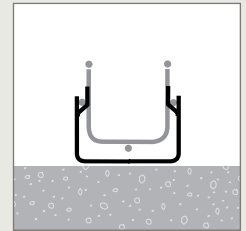
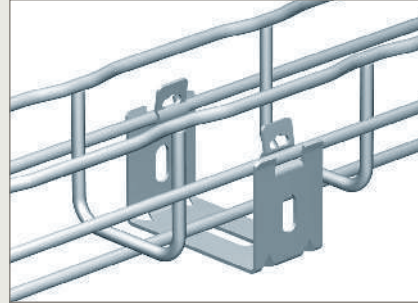

Mount directly onto floor using fasteners (not supplied)

Assembly

Securing UC50 to steel wire cable tray

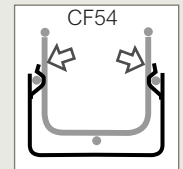
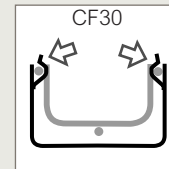
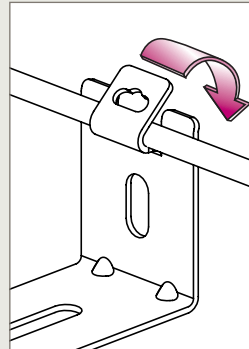

Bend tabs with pliers to secure to steel wire cable tray

Dimensions and weights

↓ 30 → 54 mm ← 50 mm

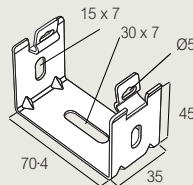

Cat. Nos.	↓ daN	Weight (kg)			
		GS	GC	304L	316L
UC50	12	0-06	0-07	0-06	0-06

Please use Cat. No. when placing your order, see p. 29

All weights are given in Kilograms (kg)

Key :

GS Pre-galvanised	304L Stainless steel 304L
GC Hot dip galvanised after manufacture	316L Stainless steel 316L

For detailed information related to finishes, refer to **p. 116-117**

→ For ceiling mounting : see p. 67

floor mounting

UFC - CSN

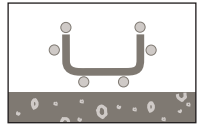

■ UFC – clamp unit / CSN – profile cantilever arms

UFC - clamp unit

Use in conjunction with CSN cantilever arms or RCSN mounting rail (see p. 82) to clamp to underfloor pedestal supports, forming an underfloor support for steel wire cable tray runs. Supplied singly with U bolt and bolts.

CSN - profile cantilever arms

Use to support 100 mm to 450 mm wide steel wire cable tray in 30 mm and 54 mm depths. Can be wall mounted (see p. 56) or pendant drop mounted using EDF mounting rail (see p. 76). Incorporate slot and tab design for easy fixing. Supplied singly without fasteners.

EPVCSN - end cap

PVC end cap for CSN profile cantilever arms. Supplied singly.

■ Installation

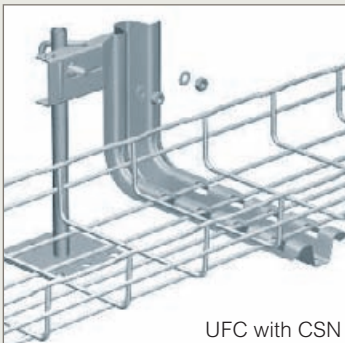

UFC with CSN

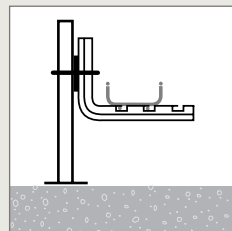

CSN is secured to UFC using U bolt and fasteners (supplied)

■ Assembly

Securing CSN to steel wire cable tray



FAS
FAST ASSEMBLING SYSTEM



Patented



Fast assembling



Fixing without nuts and bolts

Slot base wires of the tray into the cantilever arm and bend tabs with screwdriver to secure, as shown in the FAS diagram above

■ Dimensions and weights

UFC \downarrow 30 \rightarrow 105 mm \leftarrow 100 \rightarrow 600 mm

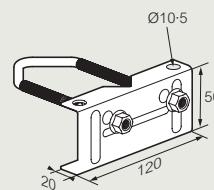

Note:
When used in conjunctions with CSN, tray widths and depths that can be supported by UFC are lower - see CSN below

Cat. No.	Weight (kg)
UFC	GS 0.24

Please use Cat. No. when placing your order, see p. 29

All weights are given in Kilograms (kg)

CSN \downarrow 30 \rightarrow 54 mm \leftarrow 100 \rightarrow 450 mm

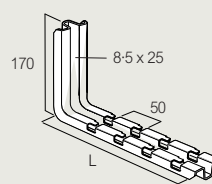

Cat. Nos.	L mm	F daN	Weight (kg)			
			GS	GC	304L	316L
CSN100	178	30	0.37	0.40	0.40	0.40
CSN150	228	110	0.42	0.47	0.41	0.41
CSN200	278	85	0.47	0.53	0.51	0.51
CSN300	378	73	0.73	0.76	0.64	0.64
CSN400	478	56	0.82	0.92	-	-
CSN450	528	50	0.91	0.97	-	-

Please use Cat. No. when placing your order, see p. 21

All weights are given in Kilograms (kg)

Key :			
GS	Pre-galvanised	304L	Stainless steel 304L
GC	Hot dip galvanised after manufacture	316L	Stainless steel 316L

For detailed information related to finishes, refer to p. 116-117

All dimensions (mm) are nominal

→ For cantilever arms : see p. 56-62

floor mounting
UFC - RCSN



■ **UFC – clamp unit / RCSN - fast fix support rails**

UFC - clamp unit

Use in conjunction with RCSN mounting rail or CSN cantilever arms (see p. 81) to clamp to underfloor pedestal supports, forming an underfloor support for steel wire cable tray runs. Supplied singly with U bolt and nuts

RCSN - fast fix support rails

Use to support 100 mm to 600 mm wide steel wire cable tray in 30 mm to 105 mm depths. Use in conjunction with UFC or mount directly to the floor. Can also be wall mounted (see p. 65) or to form a trapeze hanger using threaded rod (see p. 74). Incorporate slot and tab design for easy fixing. Supplied singly without fasteners

■ **Installation**

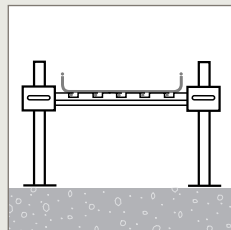
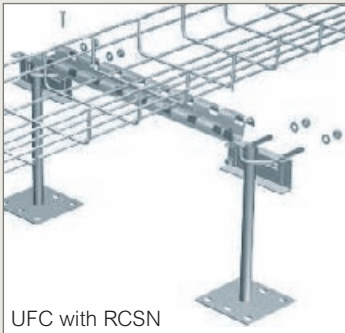

RCSN is secured to UFC using U bolt and fasteners (supplied)
Note: if 600 mm floor spacing being used, use 550 mm RCSN or below

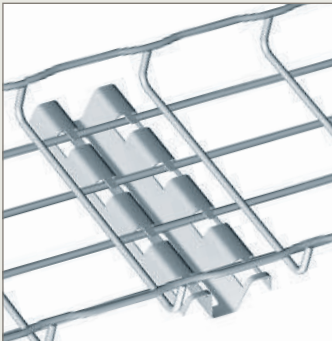

Mount RCSN directly onto floor using fasteners (not supplied)

■ **Assembly**

Securing RCSN to UFC clamp unit

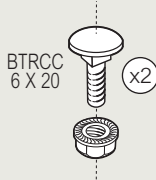
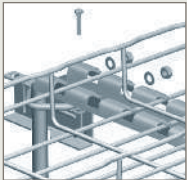

Rest RCSN on U bolt of UFC and secure down using 2 x BTRCC 6 x 20

Securing RCSN to steel wire cable tray



Patented



Fast assembling



Fixing without nuts and bolts



Slot base wires of the tray into RCSN and bend tabs with screwdriver to secure, as shown in the FAS diagram above

→ For wall mounting : see p. 65

→ For ceiling mounting : see p. 74

■ **Dimensions and weights**

UFC $\downarrow \uparrow$ 30 → 105 mm $\leftarrow \rightarrow$ 100 → 600 mm

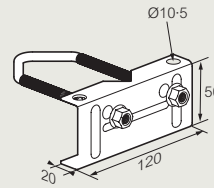

Cat. No.	Weight (kg)
UFC	0.24

Please use Cat. No. when placing your order, see p. 29

All weights are given in Kilograms (kg)

RCSN $\downarrow \uparrow$ 30 → 105 mm $\leftarrow \rightarrow$ 100 → 600 mm

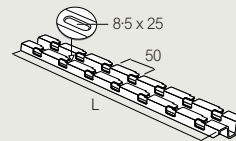

Cat. No.	L mm	Weight (kg)			
		GS	GC	304L	316L
RCSN150	150	0.16	0.17	–	0.16
RCSN200	200	0.23	0.23	–	0.22
RCSN300	300	0.33	0.36	–	0.33
RCSN400	400	0.38	0.49	–	0.45
RCSN500	500	0.54	0.61	–	0.59
RCSN550	550	0.63	0.65	–	–
RCSN600	600	0.67	0.70	–	0.69
RCSN1000	1 000	1.18	1.23	–	1.21
RCSN2000	2 000	2.20	2.42	2.30	2.30
RCSN3000	3 000	3.54	3.78	3.65	3.65

Please use Cat. No. when placing your order, see p. 28

All weights are given in Kilograms (kg)

Key :	GS Pre-galvanised	304L Stainless steel 304L
	GC Hot dip galvanised after manufacture	316L Stainless steel 316L
	For detailed information related to finishes, refer to p. 116-117	

All dimensions (mm) are nominal

beam mounting

CLMFAS – RCSN



CLMFAS – beam clamps / RCSN – fast fix support rails

CLMFAS - beam clamps

Use as a clamp to attach RCSN mounting rail to beams
Supplied singly without fasteners

RCSN - fast fix support rails

Use to support 50 mm to 600 mm wide steel wire cable tray in 30 mm to 105 mm depths in a beam mounting situation. Can also be wall mounted (see p. 65), floor mounted (see p. 82) or used to form a trapeze hanger using threaded rod (see p. 74)
Incorporate slot and tab design for easy fixing. Supplied singly without fasteners

Installation



CLMFAS with RCSN

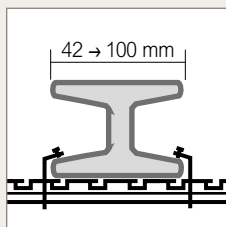

CLMFAS is secured to beams at either side with fasteners (not supplied). RCSN fast fit support rails simply pass through the opening in the CLMFAS clamp and sit on the underside of the beam
42 mm to 100 mm wide beams can be accommodated

Assembly

Securing CLMFAS to beams and to RCSN



CLMFAS is secured to beams at either side with 1 X M8 x 20 fastener per clamp (not supplied).
RCSN fast fit support rails simply pass through the opening in the CLMFAS clamp and sit on the underside of the beam

Securing RCSN to steel wire cable tray



FAS LOT
FAST ASSEMBLING SYSTEM



Patented



Fast assembling



Fixing without nuts and bolts

Slot base wires of the tray into RCSN and bend tabs with screwdriver to secure, as shown in the FAS diagram above

→ For wall mounting : see p. 65

→ For ceiling mounting : see p. 74

→ For floor mounting : see p. 82

Dimensions and weights

CLMFAS $\downarrow \uparrow$ 30 → 105 mm $\leftarrow \rightarrow$ 50 → 600 mm

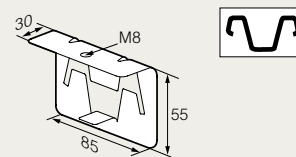

Cat. Nos.	daN.m	Weight (kg)		
		GS	Z+	316L
CLMFAS	18	0-20	0-20	0-20

Please use Cat. No. when placing your order, see p. 29

All weights are given in Kilograms (kg)

RCSN $\downarrow \uparrow$ 30 → 105 mm $\leftarrow \rightarrow$ 100 → 600 mm

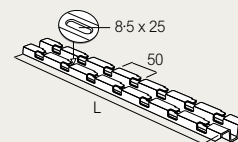

NOTE :
When used with CLMFAS 50 mm wide tray can be supported either side of a beam

Cat. No.	L mm	Weight (kg)			
		GS	GC	304L	316L
RCSN150	150	0-16	0-17	–	0-16
RCSN200	200	0-23	0-23	–	0-22
RCSN300	300	0-33	0-36	–	0-33
RCSN400	400	0-38	0-49	–	0-45
RCSN500	500	0-54	0-61	–	0-59
RCSN550	550	0-63	0-65	–	–
RCSN600	600	0-67	0-70	–	0-69
RCSN1000	1 000	1-18	1-23	–	1-21
RCSN2000	2 000	2-20	2-42	2-30	2-30
RCSN3000	3 000	3-54	3-78	3-65	3-65

Please use Cat. No. when placing your order, see p. 28

All weights are given in Kilograms (kg)

Key :

GS Pre-galvanised	304L Stainless steel 304L
GC Hot dip galvanised after manufacture	316L Stainless steel 316L
Z+ Continuous galvanisation before manufacture	

For detailed information related to finishes, refer to p. 116-117

All dimensions (mm) are nominal

beam mounting
CLMU - EDF

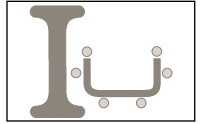

■ **CLMU – beam clamps / EDF – pendants / mounting rails**

CLMU - beam clamps

Use as a clamp to attach EDF mounting rail to beams
Supplied singly without fasteners

EDF - pendants / mounting rails

Use to support 50 mm to 600 mm wide steel wire cable tray in 30 mm to 105 mm depths in a beam mounting situation. Can also be wall mounted (see p. 58-61), or trapeze and pendant mounted from the ceiling (see p. 75-76)
Supplied singly without fasteners

■ **Installation**



CLMU with EDF

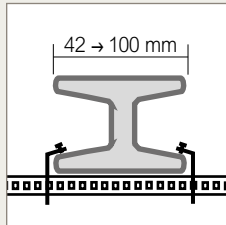

CLMU is secured to beams at either side with fasteners (not supplied). EDF mounting rails pass through the opening in the CLMU clamp and sit on the underside of the beam. 42 mm to 100 mm wide beams can be accommodated

■ **Assembly**

Securing CLMU to beams and to EDF



CLMU is secured to beams at either side with 1 X M8 x 20 fastener per clamp (not supplied)
EDF mounting rails pass through the opening in the CLMFAS clamp, sit on the underside of the beam and are secured with the fastener

Securing EDF mounting rail to steel wire cable tray

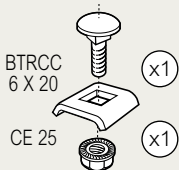

Use 1 x BTRCC 6 x 20 and 1 x CE25 to secure 50 mm to 200 mm tray EDF
For 300 mm to 600 mm tray use 2 x BTRCC 6 x 20 and 2 x CE25

→ For wall mounting : see p. 58-61

→ For ceiling (pendant / trapeze) mounting : see p. 75-76

■ **Dimensions and weights**

CLMU \downarrow 30 → 105 mm \rightarrow 50 → 600 mm

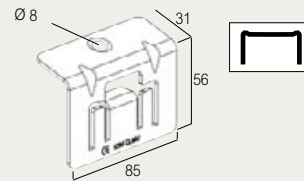

Cat. Nos.	daN.m	Weight (kg)	
		GS	Z+
CLMU	15	0.20	0.20

Please use Cat. No. when placing your order, see p. 29

All weights are given in Kilograms (kg)

EDF \downarrow 30 → 105 mm \rightarrow 100 → 600 mm

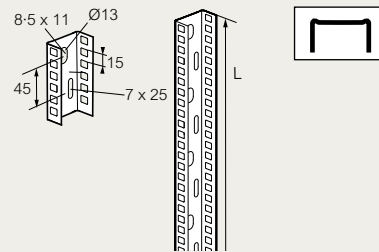

Cat. No.	L mm	daN	Weight (kg)			
			GS	GC	304L	316L
EDF600	600	50	0.77	0.83	–	–
EDF1000	1000	65	1.19	1.24	–	–
EDF2000	2000	70	2.40	2.56	2.48	2.48
EDF3000	3000	100	3.66	3.89	–	–

Please use Cat. No. when placing your order, see p. 24

All weights are given in Kilograms (kg)

Key :

GS Pre-galvanised	304L Stainless steel 304L
GC Hot dip galvanised after manufacture	316L Stainless steel 316L
Z+ Continuous galvanisation before manufacture	

For detailed information related to finishes, refer to p. 116-117

All dimensions (mm) are nominal

beam mounting EF

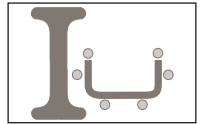

EF – adjustable beam clamps

EF adjustable beam clamps can be used to support 100 mm to 300 mm wide steel wire cable tray in 30 mm to 54 mm depths along the length of a beam. Can also be used to trapeze mount cable tray using threaded rod. Supplied singly without fasteners

Installation

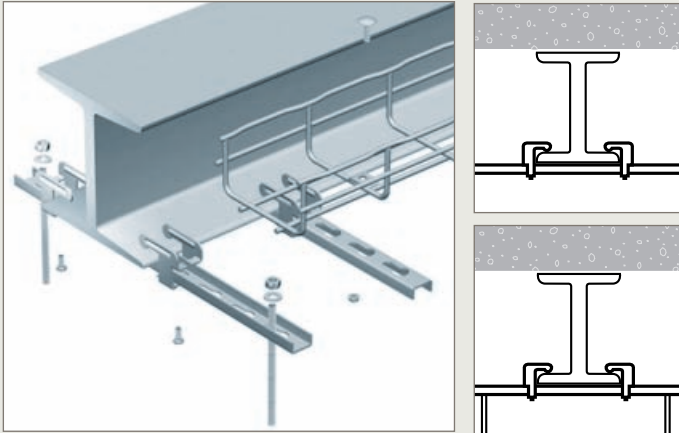

EF is secured to beams at either side with fasteners (not supplied)
Steel wire cable tray can be mounted directly to the channel piece, or suspended below using threaded rod

Assembly

Securing EF adjustable beam clamp to steel wire cable tray

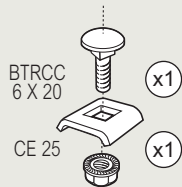

Use 1 x BTRCC 6 x 20 and 1 x CE25 to secure EF to tray

Dimensions and weights

30 → 54 mm 100 → 300 mm

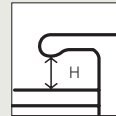
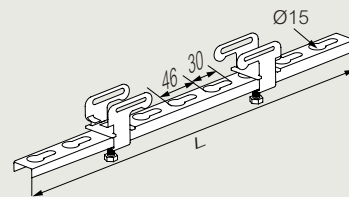

H denotes the adjustable height range (see table below)

Cat. Nos.	L mm	H mm	daN.m	Weight (kg) EZ
EF11/400	400	1→11	3.5	0.22
EF15/600	600	1→15	5.5	0.22

Please use Cat. No. when placing your order, see p. 29

All weights are given in Kilograms (kg)

Key : **EZ** Electrogalvanising after manufacture

For detailed information related to finishes, refer to **p. 116-117**

All dimensions (mm) are nominal

other mounting – take-off plates
SBDN – SBD – EXSBD

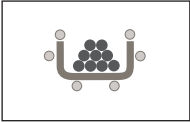

■ **SBDN – universal conduit take-off plates**

Mount to the base or side of steel wire cable tray to accept 20 mm or 25 mm diameter conduits. Use with 50 mm to 600 mm wide steel wire cable tray in 30 mm to 150 mm depths
 Supplied singly without fasteners

■ **Installation and assembly**

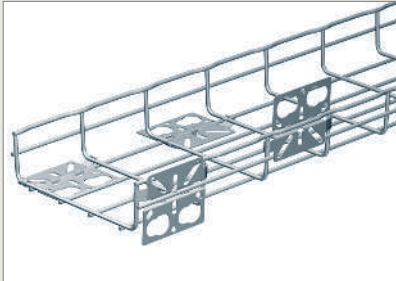

Fixing without nuts and bolts

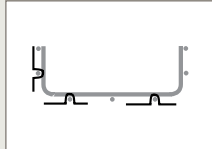

Position SBDN using the groove and bend tabs to secure

■ **Dimensions and weights**

⏏ 30 → 150 mm ⏏ 50 → 600 mm

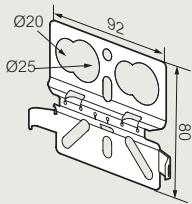

Cat. No.	Weight (kg)	
	GS	Z+
SBDN	0.2	0.2

Please use Cat. No. when placing your order, see p. 30

All weights are given in Kilograms (kg)

Key : GS Pre-galvanised
Z+ Continuous galvanisation before manufacture

For detailed information related to finishes, refer to **p. 116-117**

All dimensions (mm) are nominal

■ **SBD – conduit take-off plates**
EXSBD – switch box take-off plate

SBD

Mount to the side of steel wire cable tray to accept 20 mm or 25 mm diameter conduits. Use with 50 mm to 600 mm wide steel wire cable tray in 30 mm to 150 mm depths. SBD can also accept EXSBD switch box plate (below). Incorporate slot and tab design for easy fixing
 Supplied singly. No fasteners required

EXSBD

Clip to SBD conduit take-off plates to enable mounting of switch boxes or junction boxes
 Supplied singly. No fasteners required

■ **Installation and assembly**

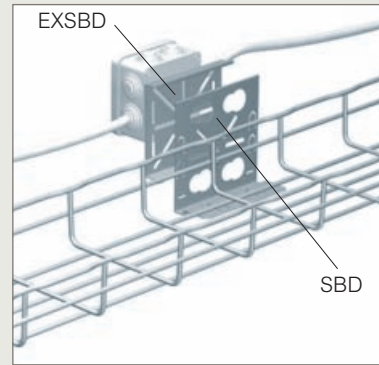

Fixing without nuts and bolts

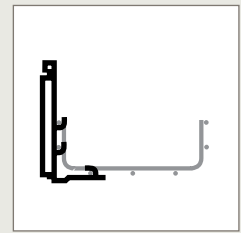

Fold tabs to secure SBD. EXSBD clips onto SBD using the slot position provided

■ **Dimensions and weights**

⏏ 30 → 150 mm ⏏ 50 → 600 mm

SBD

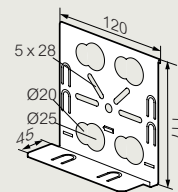

EXSBD

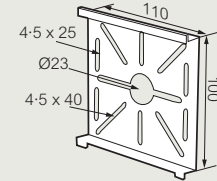

Cat. No.	Weight (kg)	
	GS	316L
SBD	0.1	0.1

Cat. No.	Weight (kg)
	GS
EXSBD	0.07

Please use Cat. No. when placing your order, see p. 30

All weights are given in Kilograms (kg)

Key : GS Pre-galvanised 316L Stainless steel 316L

For detailed information related to finishes, refer to **p. 116-117**

All dimensions (mm) are nominal

other mounting – universal mounting plates

CM50 – CM50XL – CAT40

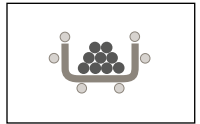

■ CM50 – universal mounting plates (small) / CM50XL – universal mounting plates (large) / CAT40 – channel fixing plates

CM50 - universal mounting plates (small)

Mount to the side of steel wire cable tray as an ancillary mounting plate. Use with 50 mm to 600 mm wide steel wire cable tray in 30 mm, 54 mm and 105 mm depths. CM50 can also be used to mount cable tray to the wall (see p 55)

Incorporate slot and tab design for easy fixing
Supplied singly. No fasteners required

CM50XL - universal fixing plates (large)

Mount to the side of steel wire cable tray as an ancillary mounting plate. Use with 50 mm to 600 mm wide steel wire cable tray in 30 mm, 54 mm and 105 mm depths. CM50XL can also be used to mount cable tray to the wall (see p 55), floor (see p. 78) or ceiling (see p. 69)

Incorporate slot and tab design for easy fixing
Supplied singly. No fasteners required

CAT40 - channel fixing plates

Mount to the side of steel wire cable tray as an ancillary mounting plate. Use with 50 mm to 600 mm wide steel wire cable tray in 30 mm, 54 mm and 105 mm depths. CAT40 can also be used to mount cable tray to the wall (see p 54)

Supplied singly. No fasteners required

■ Installation and assembly

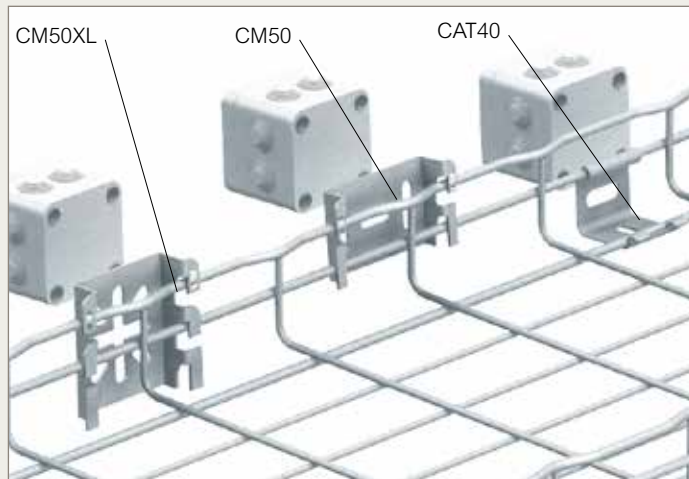

CM50, CM50XL and CAT 40 plates are clipped onto the side rail of the tray to accommodate ancillary items. No fasteners are required to attach plates onto tray



Fixing without nuts and bolts

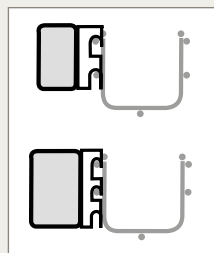

CM50 and CM50XL in side profile with ancillary items mounted to the flat side

■ Dimensions and weights

30 / 54 / 105 mm 50 → 600 mm

CM50

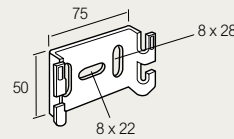

Cat. Nos.	Weight (kg)			
	GS	GC	304L	316L
CM50	0-08	0-08	0-07	0-07

Please use Cat. No. when placing your order, see p. 31

All weights are given in Kilograms (kg)

CM50XL

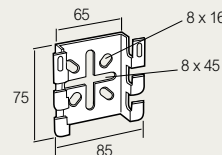

Cat. Nos.	Weight (kg)			
	GS	GC	304L	316L
CM50XL	0-10	0-11	0-08	0-08

Please use Cat. No. when placing your order, see p. 31

All weights are given in Kilograms (kg)

CAT40

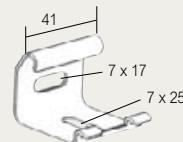

Cat. Nos.	Weight (kg)		
	GS	DC	316L
CAT40	0-04	0-04	0-04

Please use Cat. No. when placing your order, see p. 31

All weights are given in Kilograms (kg)

Key :			
GS	Pre-galvanised	304L	Stainless steel 304L
GC	Hot dip galvanised after manufacture	316L	Stainless steel 316L
DC	Geomet	For detailed information related to finishes, refer to p. 116-117	

All dimensions (mm) are nominal

→ For wall mounting : see p. 54-55

→ For ceiling mounting : see p. 69

→ For floor mounting : see p. 78

other mounting – universal mounting plates
CM50XXL – CM50WL

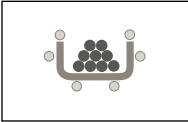

■ **CM50XXL – universal mounting plates (extra large) / CM50WL – universal Wieland mounting plates**

CM50XXL - universal mounting plates (extra large)

Mount to the side of steel wire cable tray to accept conduit or switch / junction boxes. Use with 50 mm to 600 mm wide steel wire cable tray in 30 mm to 105 mm depths. Incorporate slot and tab design for easy fixing. Supplied singly. No fasteners required

CM50WL

Mount to the side or base of steel wire cable tray as a Wieland ancillary mounting plate. Use with 50 mm to 600 mm wide steel wire cable tray in 30 mm to 105 mm depths. Incorporate slot and tab design for easy fixing. Supplied singly. No fasteners required

■ **Installation and assembly**

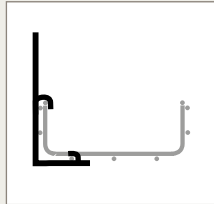
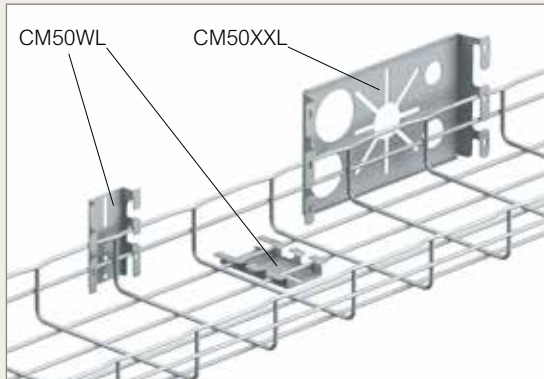

CM50WL and CM50XXL are clipped onto the side rail of the tray to accommodate ancillary items. No fasteners are required to attach plates onto tray



Fixing without nuts and bolts

■ **Dimensions and weights**

↓ 30 → 105 mm ↔ 50 → 600 mm

CM50XXL

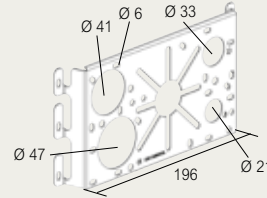

Cat. No.	Weight (kg)	
	GS	DC
CM50XXL	0.24	0.24

Please use Cat. No. when placing your order, see p. 31

All weights are given in Kilograms (kg)

CM50WL

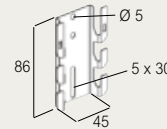

Cat. No.	Weight (kg)	
	GS	Z+
CM50WL	0.05	0.05

Please use Cat. No. when placing your order, see p. 31

All weights are given in Kilograms (kg)

Key :	GS Pre-galvanised	
	DC Geomet	
	Z+ Continuous galvanisation before manufacture	For detailed information related to finishes, refer to p. 116-117

All dimensions (mm) are nominal

other mounting – luminaire supports

SL50 – SL100 – MFM – MFPOLYA



■ SL50 / SL100 – luminaire supports

Mount to the base of steel wire cable tray to suspend luminaires from the base of the tray run. SL50 can also be used to mount 50 mm wide cable tray to the ceiling, (see p. 66)
Supplied singly without fasteners

■ Installation and assembly

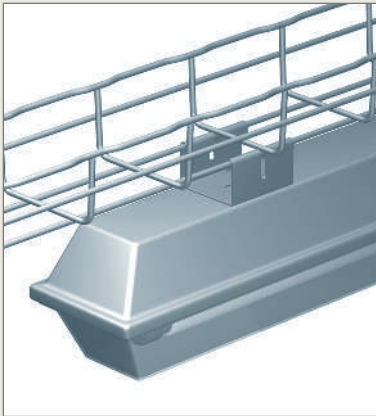

Fixing without nuts and bolts

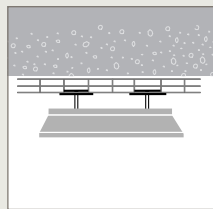

SL50 / SL100 luminaire supports clip onto the base wires of the tray
No fasteners required to secure bracket to tray

■ Dimensions and weights

SL 50

Height: 30 → 54 mm Length: 50 mm

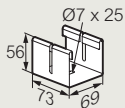

Cat. Nos.	H mm	F daN	Weight (kg) GS
SL50	56	150	0.19

Please use Cat. No. when placing your order, see p. 32

All weights are given in Kilograms (kg)

SL 100

Height: 30 → 105 mm Length: 100 → 600 mm

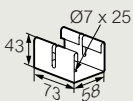

Cat. Nos.	H mm	F daN	Weight (kg) GS
SL100	43	150	0.14

Please use Cat. No. when placing your order, see p. 32

All weights are given in Kilograms (kg)

Key : **GS** Pre-galvanised

For detailed information related to finishes, refer to **p. 116-117**

All dimensions (mm) are nominal

■ MFM – MFPOLYA – multifix base plates

Mount inside the tray bed to allow for additional base mounting options for extra services
Supplied singly without fasteners

■ Installation and assembly

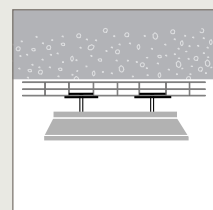
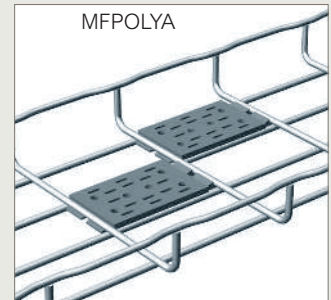
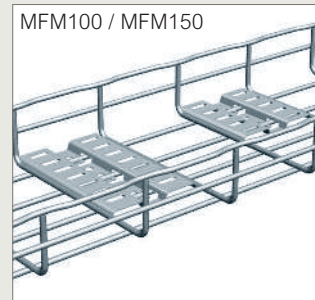

MFM100 / MFM150 and MFPOLYA can all be used to suspend luminaires from the base of the tray run



Fixing without nuts and bolts

■ Dimensions and weights

Height: 30 → 150 mm Length: 100 → 600 mm

MFM100

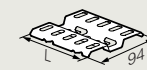

MFM150



MFPOLYA

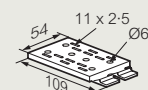

Cat. No.	L mm	Weight (kg)			
		GS	Z+	316L	POLYIMIDE
MFM100	100	0.07	0.07	0.07	–
MFM150	150	0.11	0.11	–	–
MFPOLYA	109	–	–	–	0.03

Please use Cat. No. when placing your order, see p. 32

All weights are given in Kilograms (kg)

Key : **GS** Pre-galvanised **316L** Stainless steel 316L

Z+ Continuous galvanisation before manufacture

Polyamide

For detailed information related to finishes, refer to **p. 116-117**

All dimensions (mm) are nominal

➔ For ceiling mounting : see p. 66

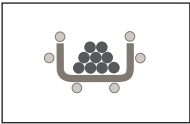

■ **FAS ROLLER – cabling roller**

Enables the easy installation of cables into a steel wire cable tray run using the cable roller tools, mounting plates and clamps
Supplied with roller, mounting plate and clamp

■ **Installation and assembly**

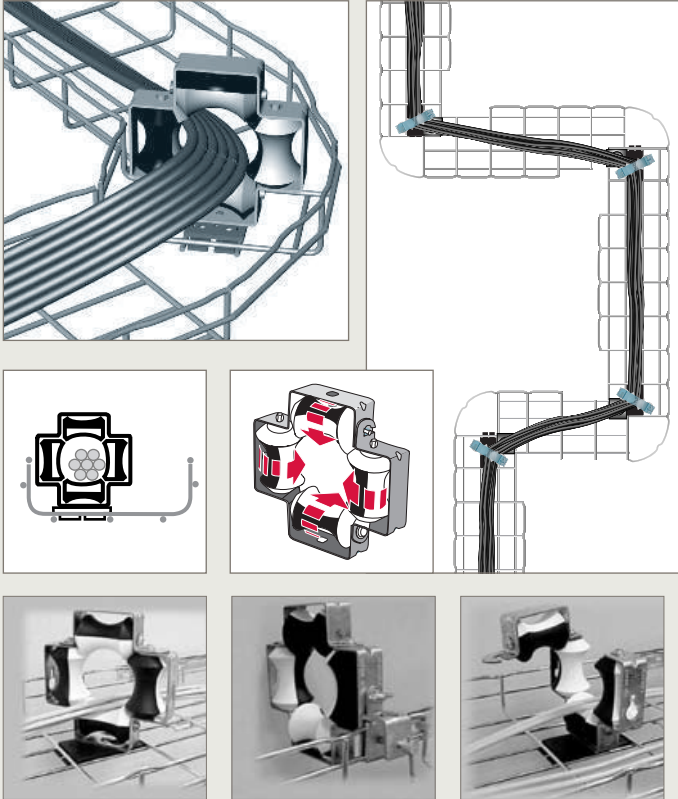

FASROLLER is fitted to the base of the tray at every corner

■ **Dimensions and weights**

↕ 30 → 150 mm ↔ 50 → 600 mm

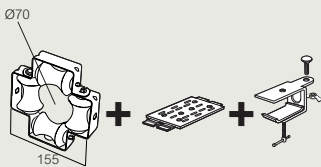

Cat. No.	Weight (kg)
FAS ROLLER	5.01

Please use Cat. No. when placing your order, see p. 33

All weights are given in Kilograms (kg)

Key : GS Pre-galvanised

For detailed information related to finishes, refer to **p. 116-117**

All dimensions (mm) are nominal

■ **DEV100 – cable dropout plates**

Base mounted cable drop out plate to aid cable egress
Incorporates slot and tab design for easy fixing. Supplied singly

■ **Installation and assembly**

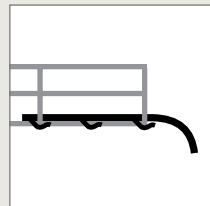
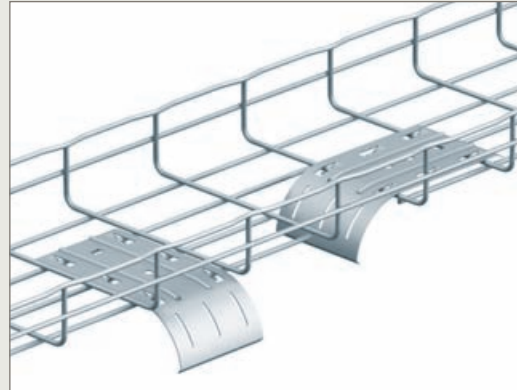

Fixing without nuts and bolts

DEV100 dropout plates are fitted inside the tray bed by folding the tabs
Can be fitted along the length of the run or across the width to enable cable egress

■ **Dimensions and weights**

↕ 30 → 150 mm ↔ 100 → 600 mm



Cat. Nos.	Weight (kg)		
	GS	Z+	316L
DEV100	0.17	0.14	0.13

Please use Cat. No. when placing your order, see p. 33

All weights are given in Kilograms (kg)

Key : GS Pre-galvanised 316L Stainless steel 316L

Z+ Continuous galvanisation before manufacture

For detailed information related to finishes, refer to **p. 116-117**

All dimensions (mm) are nominal

cablings accessories

CABLOGRIP - CLIP

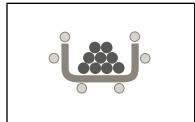

■ CABLOGRIP – cable grip

Banding strip used to form and secure a cable bundle within a steel wire cable tray run
Supplied singly

■ Installation and assembly



CABLOGRIP forms an organised bundle of cables which can then be secured

■ Dimensions and weights

⌈ 30 → 150 mm ⌋ 100 → 600 mm



Cat. No.	L mm	Weight (kg) OTHER
CABLOGRIP	5 000	0.93

Please use Cat. No. when placing your order, see p. 33

All weights are given in Kilograms (kg)

■ CLIP - identification tags

Coloured identification tag attaches to the side of steel wire cable tray
Supplied in packs of 50

■ Installation and assembly



CLIP identification clips attach to the side rail of the tray run
No fasteners required

■ Dimensions and weights

⌈ 30 → 150 mm ⌋ 50 → 600 mm

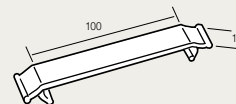

Cat. No.	Weight (kg) PLAST
CLIPJ	0.01
CLIPV	0.01
CLIPB	0.01
CLIPO	0.01
CLIPG	0.01
CLIPP	0.01
CLIPR	0.01
CLIPW	0.01
CLIPN	0.01

Please use Cat. No. when placing your order, see p. 33

All weights are given in Kilograms (kg)

Key : Plastic

For detailed information related to finishes, refer to p. 116-117

All dimensions (mm) are nominal

cabling accessories
PA

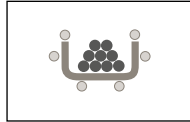

■ **PA - radius support**

Used as a corner assembly in conjunction with site fabricated fittings
Supplied singly without fasteners

■ **Installation**

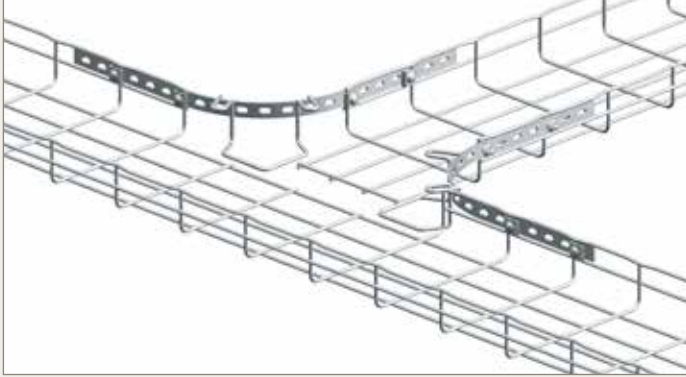

PA fitted to form a radius support for site fabricated bends to ensure a smooth bending. Fasteners required (not supplied)

■ **Assembly**

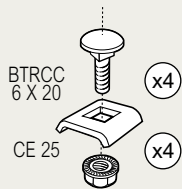

Use 4 x BTRCC 6 x 20 and 1 x CE25 to secure PA to tray

■ **Dimensions and weights**

↕ CF30 / CF54 / CF105 mm ↔ 50 → 600 mm

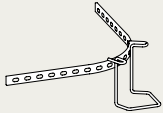

Cat. Nos.	H mm	Weight (kg)	
		EZ	GC
PA1	30	0.25	0.29
PA2	54	0.27	0.31
PA4	105	0.29	0.33

Please use Cat. No. when placing your order, see p. 33

All weights are given in Kilograms (kg)

earthing
BLF



■ **BLF – earth conductor clamps (copper)**

Side mounted earth conductor clamp fits directly to side wires of steel wire cable tray. Use for protective conductors with a cross section of 16, 35 and 50 mm². Supplied singly

■ **Installation**

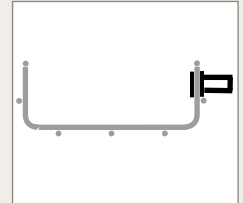
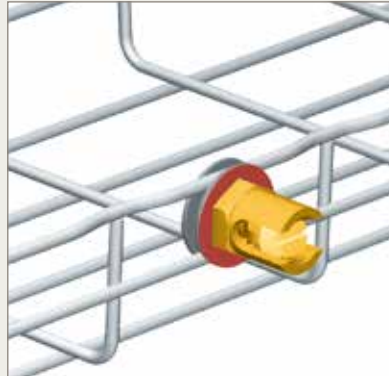

BLF attaches to side rail of tray

■ **Assembly**



Clamp in place with the earthing point outside of the tray

■ **Dimensions and weights**

↕ 30 → 150 mm ↔ 50 → 600 mm

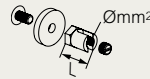

Cat. Nos.	L mm	Ø mm ²	Weight (kg)
			CU
BLF8/16	22	16	0.05
BLF8/35	24	35	0.06
BLF8/50	26	50	0.07

Please use Cat. No. when placing your order, see p. 34

All weights are given in Kilograms (kg)

Key : EZ Electrogalvanising after manufacture
GC Hot dip galvanised after manufacture

For detailed information related to finishes, refer to **p. 116-117**

All dimensions (mm) are nominal

Key : CU Copper

For detailed information related to finishes, refer to **p. 116-117**

All dimensions (mm) are nominal

earthing

GRIFEQUIP - GRIFEQUIP 2

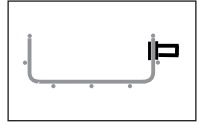

■ GRIFEQUIP – earth conductor clamp (aluminium) GRIFEQUIP 2 – vertical earth clamp (aluminium)

Side mounted earth conductor clamp fits directly to steel wire cable tray. Use for protective conductors with a cross section of between 6 and 35 mm²
Supplied singly

■ Installation

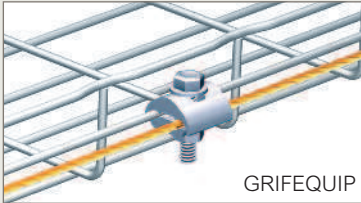

GRIFEQUIP

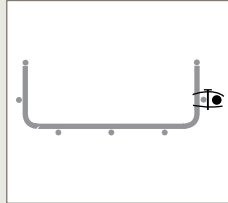

GRIFEQUIP clamps to the side rail of tray

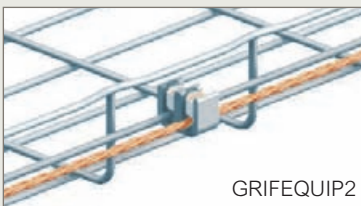

GRIFEQUIP2

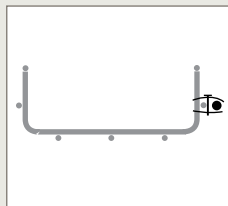

GRIFEQUIP2 clamps to the side rail of tray

■ Dimensions and weights

CF30 / CF54 / CF105 mm 50 → 600 mm

GRIFEQUIP



Ø – 6 X 35 mm²

GRIFEQUIP 2



Ø – 6 X 35 mm²

Cat. Nos.	Weight (kg)
	AL
GRIFEQUIP	0.02
GRIFEQUIP2	0.04

Please use Cat. No. when placing your order, see p. 34

All weights are given in Kilograms (kg)

Key :  Aluminium

For detailed information related to finishes, refer to **p. 116-117**

All dimensions (mm) are nominal

installati guide

INSTALLATION GUIDE

HOW TO CUT STEEL WIRE CABLE TRAY

Using manual croppers or electric cutting tool	96
Installing FASLOCK AUTO and fixing kits	97

CREATING RADIUS BENDS

Large radius bends using FASLOCK AUTO	98 - 99
Large radius bends using fixing kits	100 - 101
Small radius bends	102 - 103

FABRICATING OTHER FITTINGS

Right angle bends	104 - 105
T-junction or crossover at right angles	106 - 107
T-junction or crossover with gusset	108 - 109
Reducers	110
Changing level	111





■ How to cut a cable tray

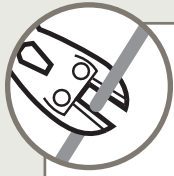

Coupefilgm - croppers



Cat. No.	L mm	KG kg/m
CM559507	630	2.7

→ Coupefilgm : see p. 35

Off-set jaw arrangement

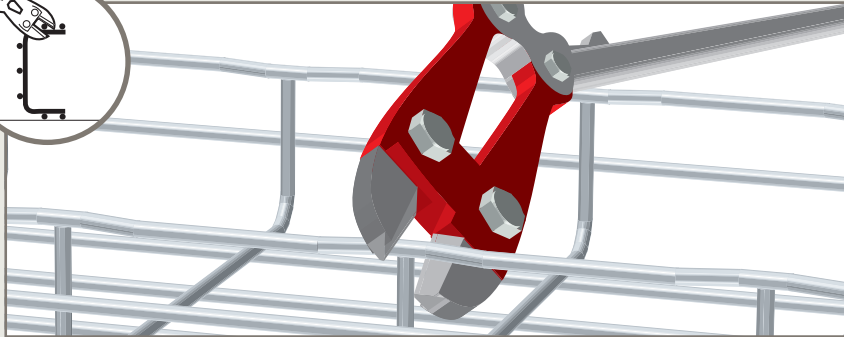
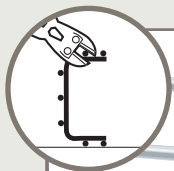
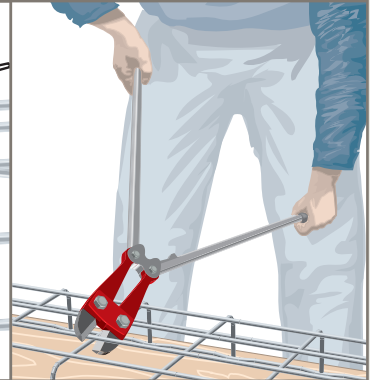
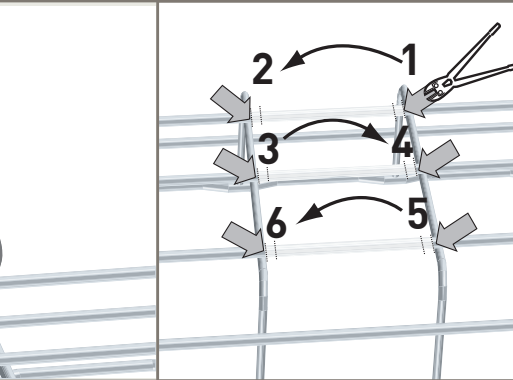
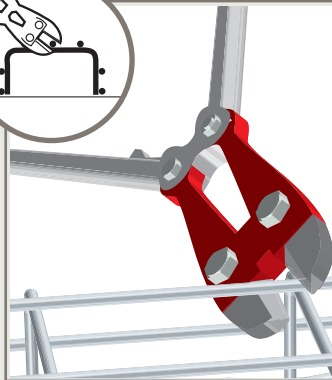
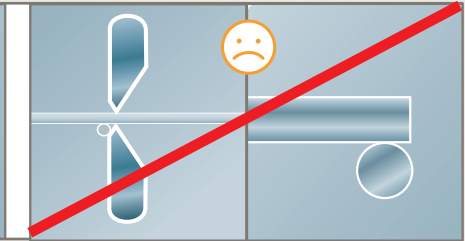
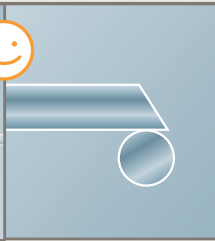
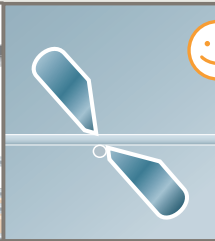
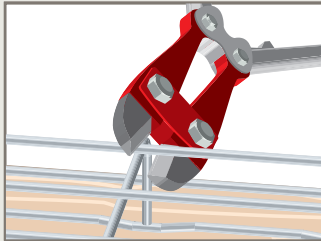
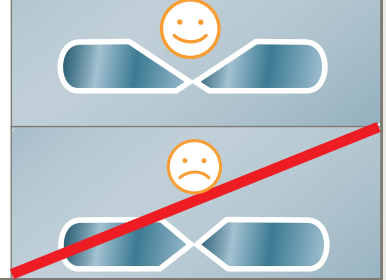

Cutyfil - electric cutting tool

Cat. No.	KG kg/m
CUTYFIL	3.7

→ Cutyfil : see p. 35



All dimensions (mm) are nominal

cable tray installation

technical information

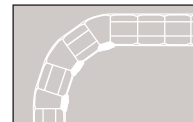

How to cut a cable tray (continued)

FASLOCK AUTO \leftrightarrow 100 → 600 mm

Pull + click

Pull + click

→ FASLOCK AUTO : see p. 18

CE25 / CE30 \leftrightarrow 50 → 600 mm

A

BTRCC (x1)
CE 30 (x1)
CE 25 (x1)

→ Fixing kits : see p. 19

1

CE25

2

CE25

3

B

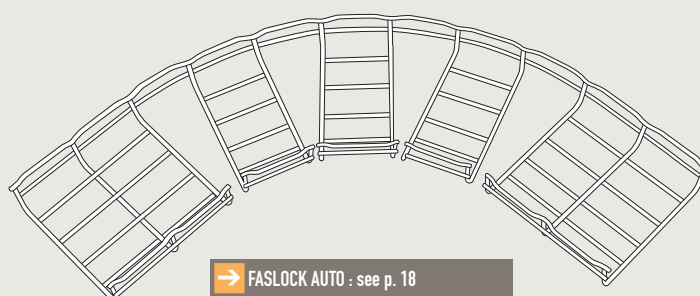

BTRCC 6X20 (2)
+ CE 25 (2)
+ ED 275 (1)

→ Joint strips / fixing kits : see p. 18-19

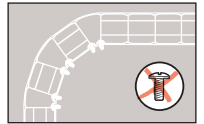

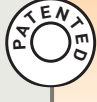

■ Large radius bends using FASLOCK AUTO





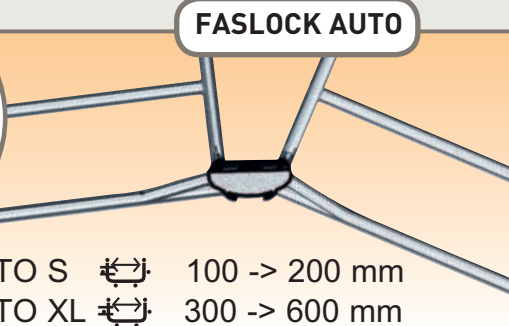

FASLOCK AUTO

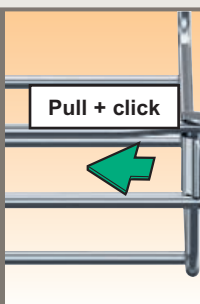

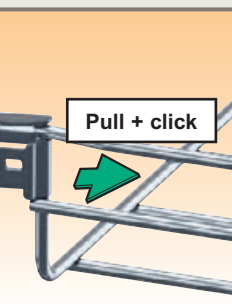



FASLOCK AUTO S $\leftarrow \rightarrow$ 100 -> 200 mm
 FASLOCK AUTO XL $\leftarrow \rightarrow$ 300 -> 600 mm

$\leftarrow \rightarrow$ 100 mm

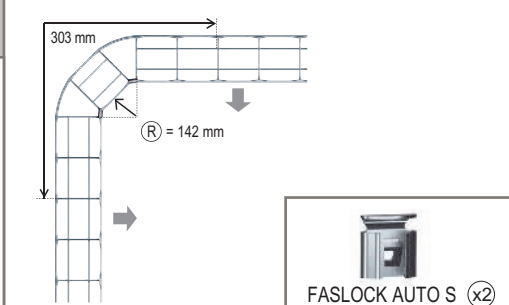

303 mm
 $R = 142$ mm
 FASLOCK AUTO S (x2)

$\leftarrow \rightarrow$ 150 mm

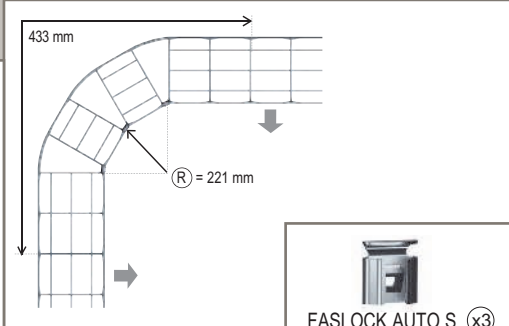

433 mm
 $R = 221$ mm
 FASLOCK AUTO S (x3)

$\leftarrow \rightarrow$ 200 mm

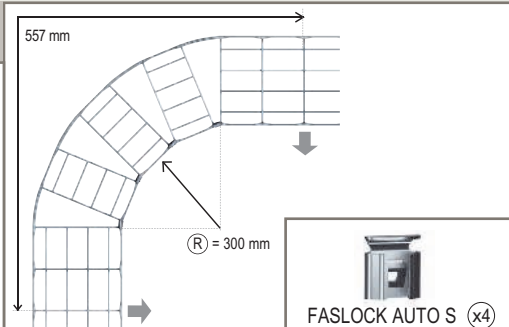

557 mm
 $R = 300$ mm
 FASLOCK AUTO S (x4)

$\leftarrow \rightarrow$ 300 mm

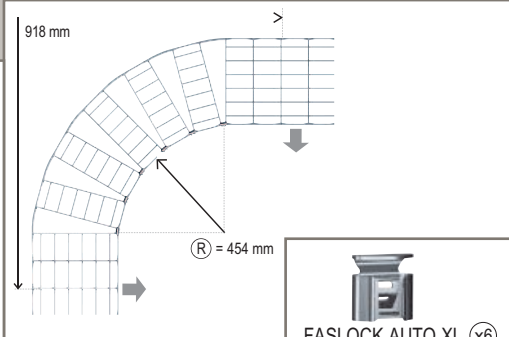

918 mm
 $R = 454$ mm
 FASLOCK AUTO XL (x6)

All dimensions (mm) are nominal

cable tray installation

technical information

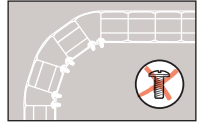

Large radius bends using FASLOCK AUTO (continued)

↔ 400 mm

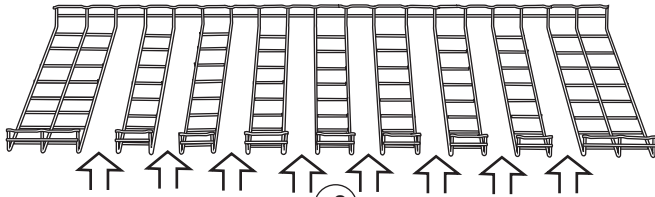

1177 mm

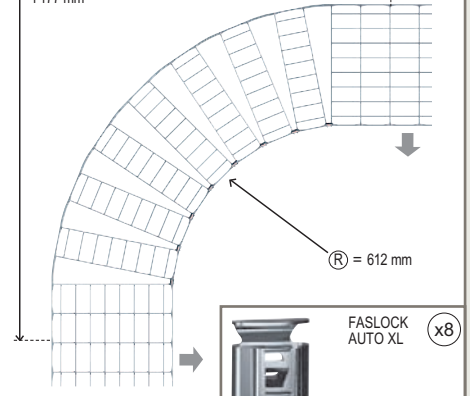

↔ 450 mm

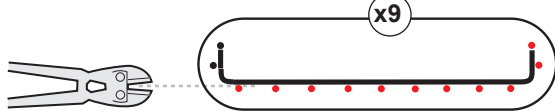
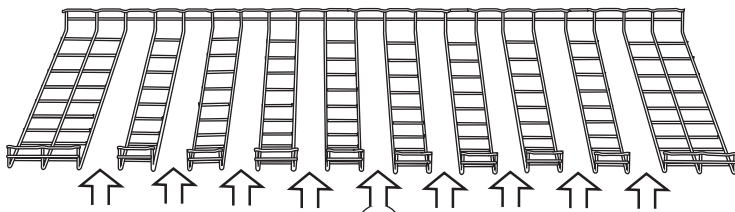

1279 mm

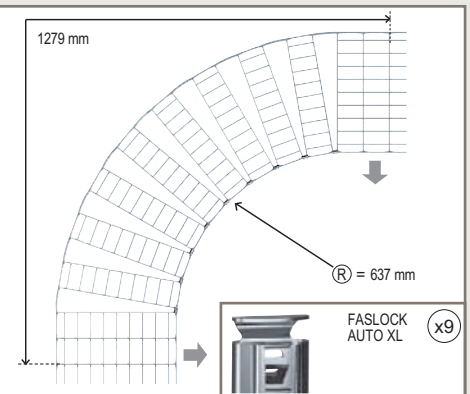

↔ 500 mm

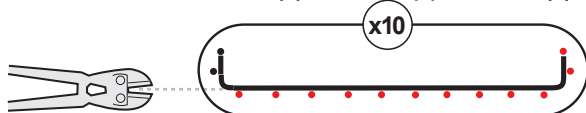
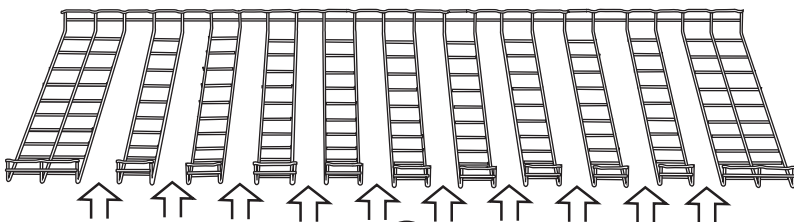

1422 mm

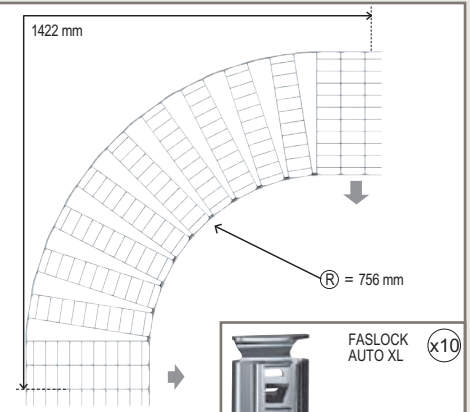

↔ 600 mm

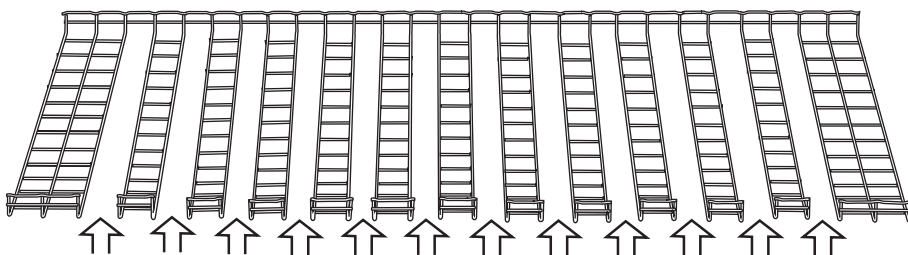

1675 mm

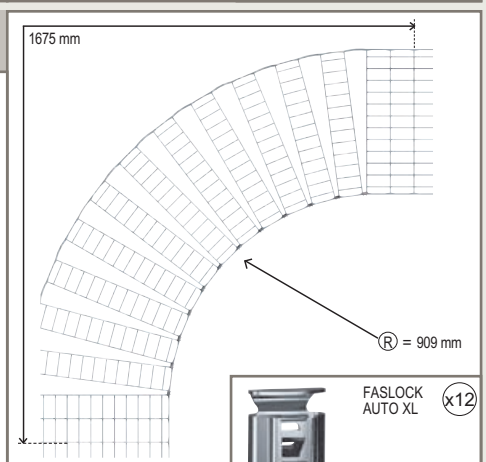

All dimensions (mm) are nominal

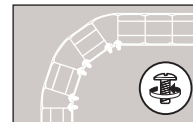

■ Large radius bends using fixing kits

↪ 50 mm

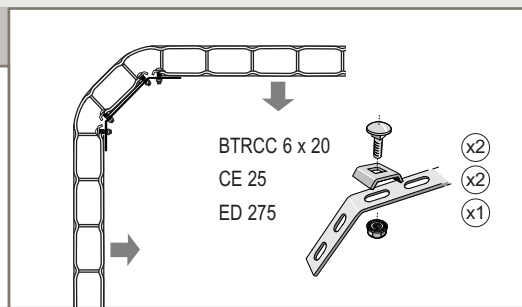
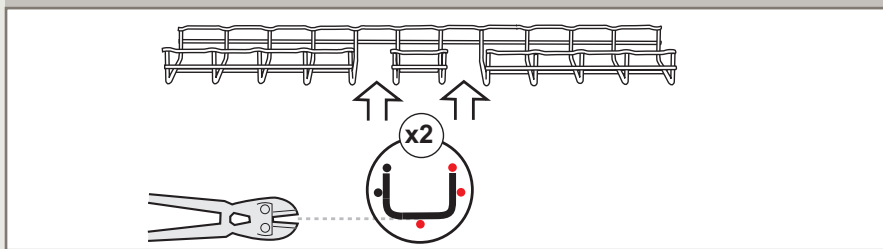

↪ 100 mm

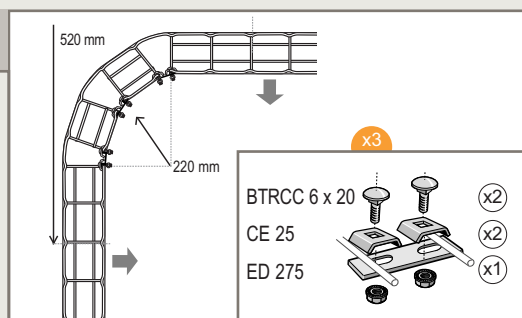
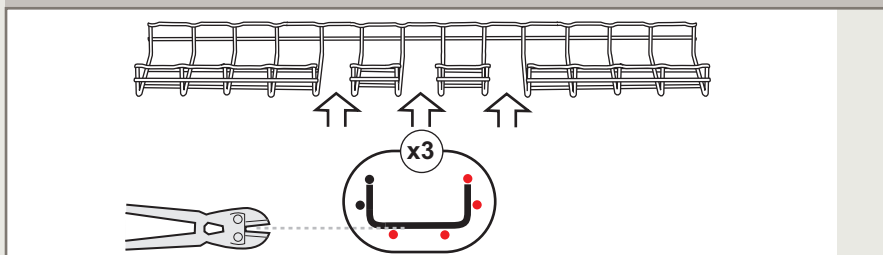

↪ 150 mm

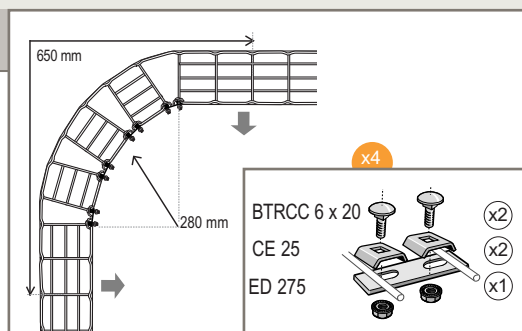
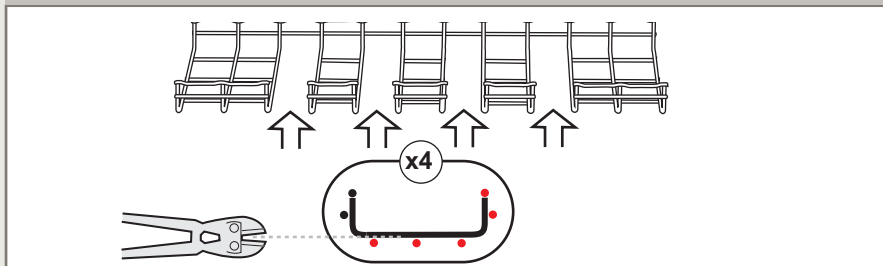

↪ 200 mm

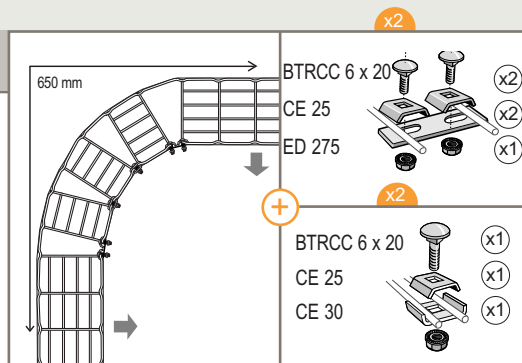
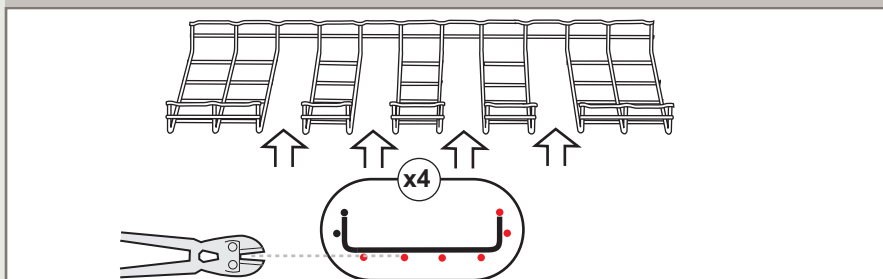

↪ 300 mm

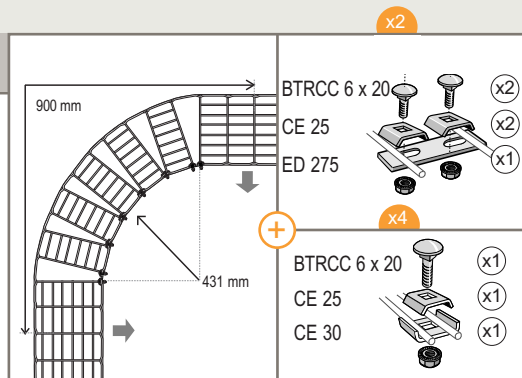
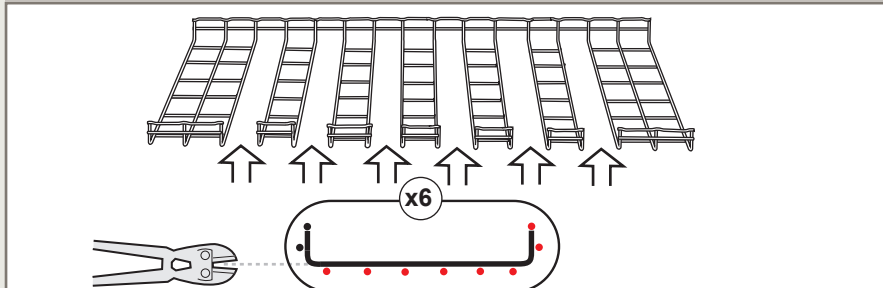

All dimensions (mm) are nominal

cable tray installation

technical information

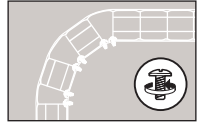

Large radius bends using fixing kits (continued)

↔ 400 - 450 mm

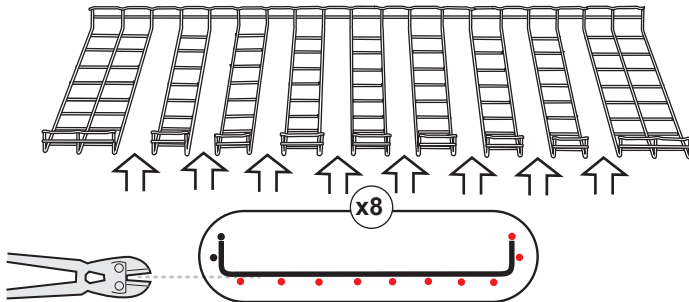

BTRCC 6 x 20 (x2)
 CE 25 (x2)
 ED 275 (x1)

+

BTRCC 6 x 20 (x1)
 CE 25 (x1)
 CE 30 (x1)

↔ 500 mm

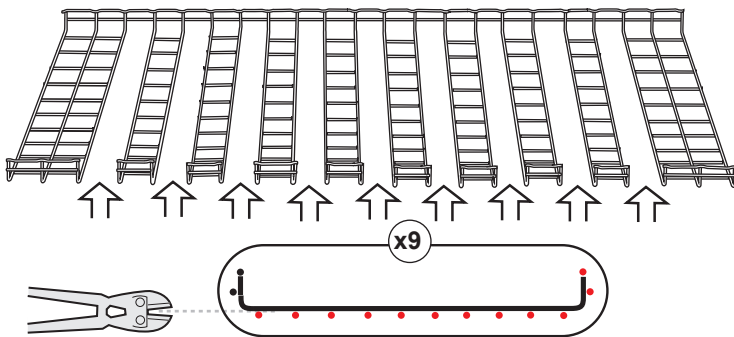

BTRCC 6 x 20 (x1)
 CE 25 (x1)
 CE 30 (x1)

↔ 600 mm

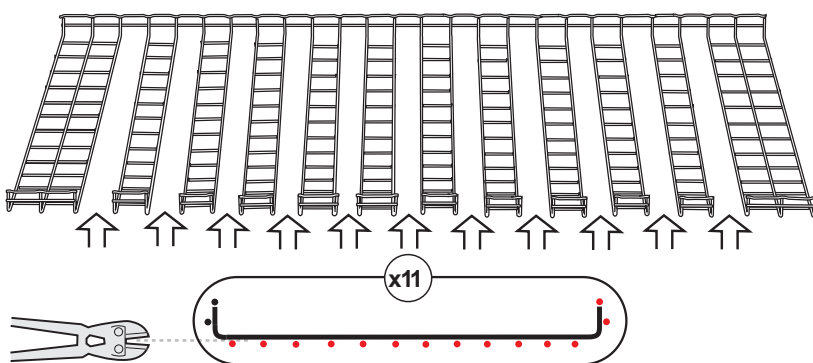

BTRCC 6 x 20 (x1)
 CE 25 (x1)
 CE 30 (x1)

All dimensions (mm) are nominal



■ Small radius bends

↔ 50 mm

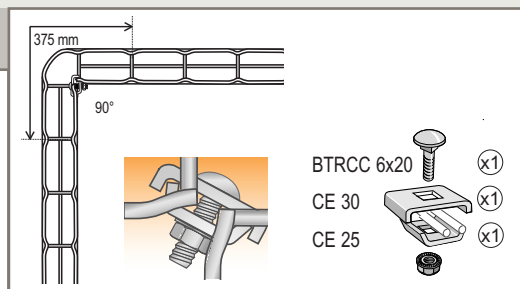
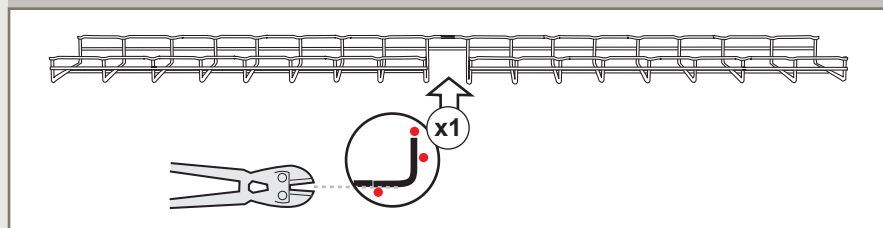

↔ 100 mm

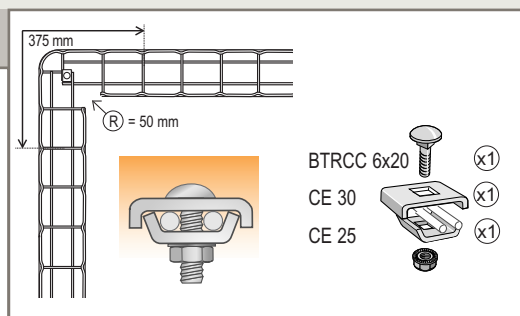
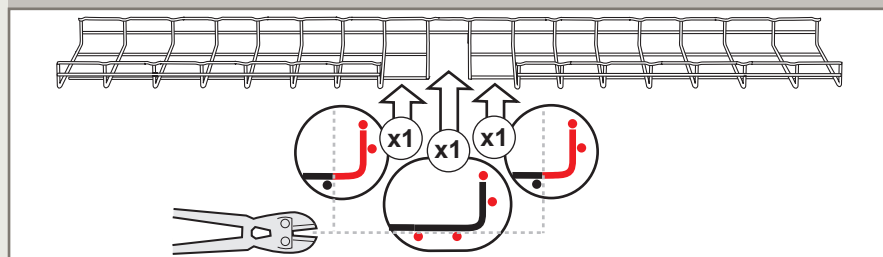

↔ 150 mm

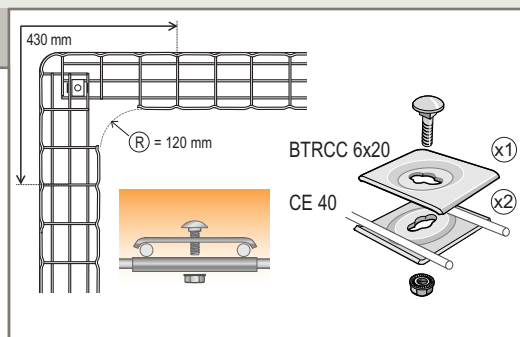
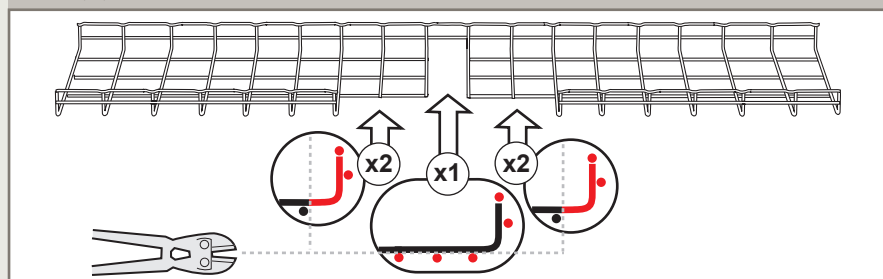

↔ 200 mm

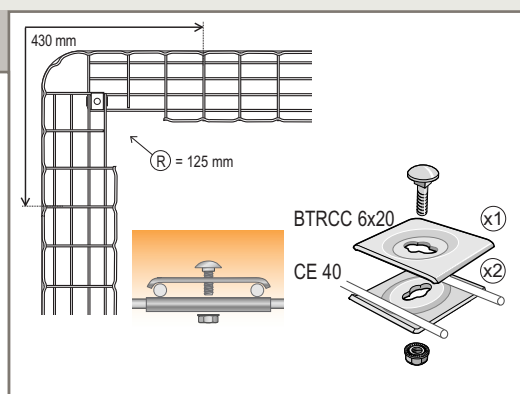
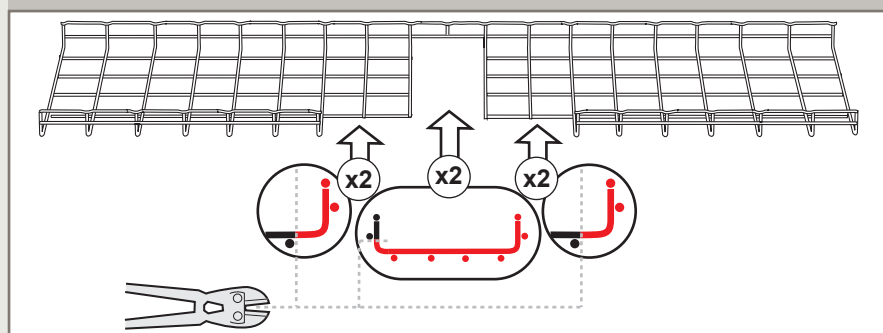

↔ 300 mm

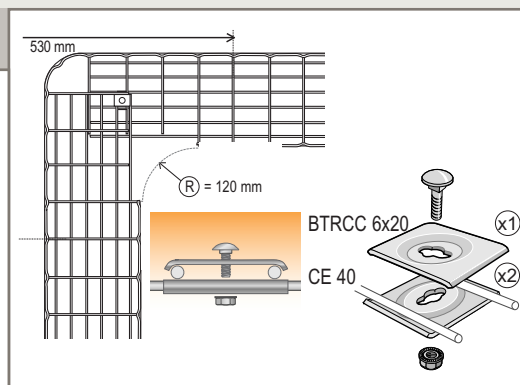
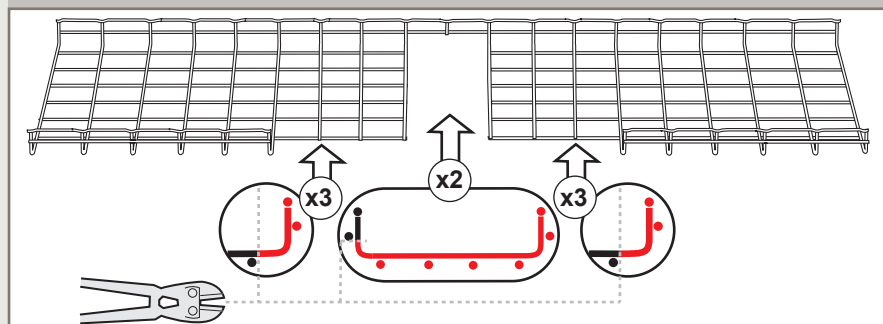

All dimensions (mm) are nominal

→ CE40 : see p. 25

→ Fixing kits : see p. 19

cable tray installation

technical information

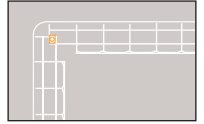

■ Small radius bends (continued)

↔ 400 - 450 mm

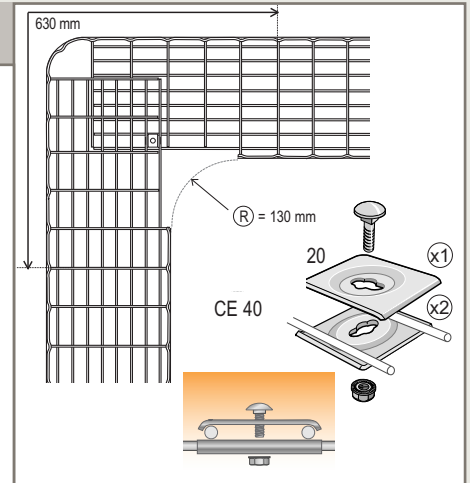
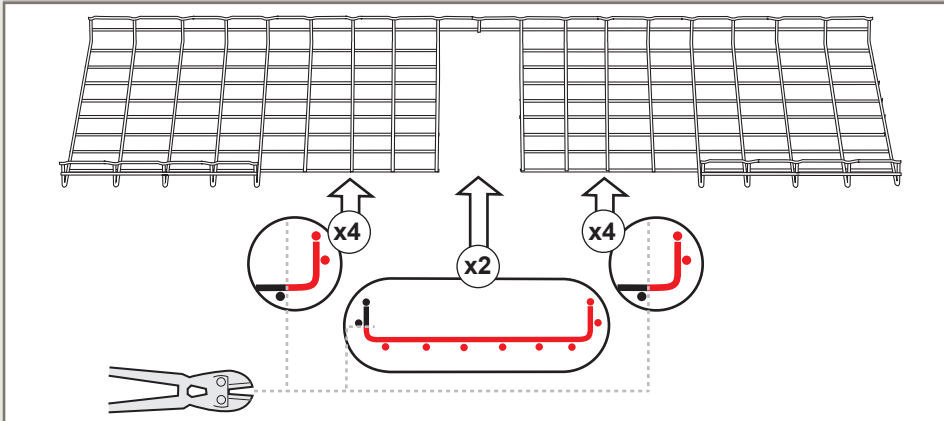

↔ 500 mm

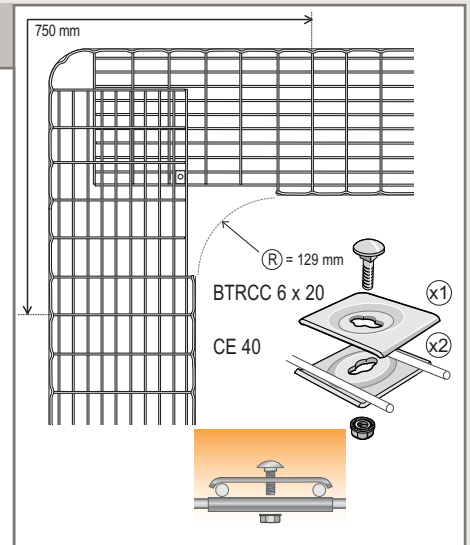
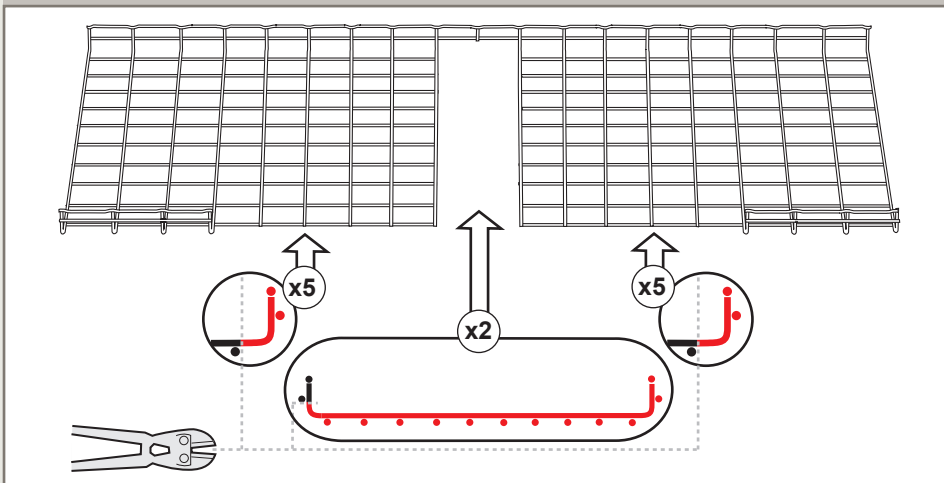

↔ 600 mm

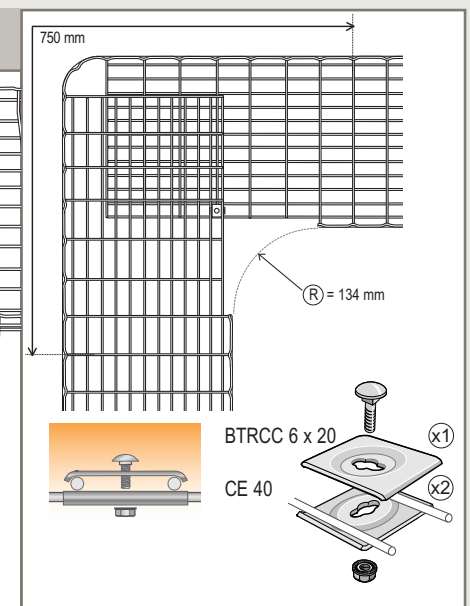
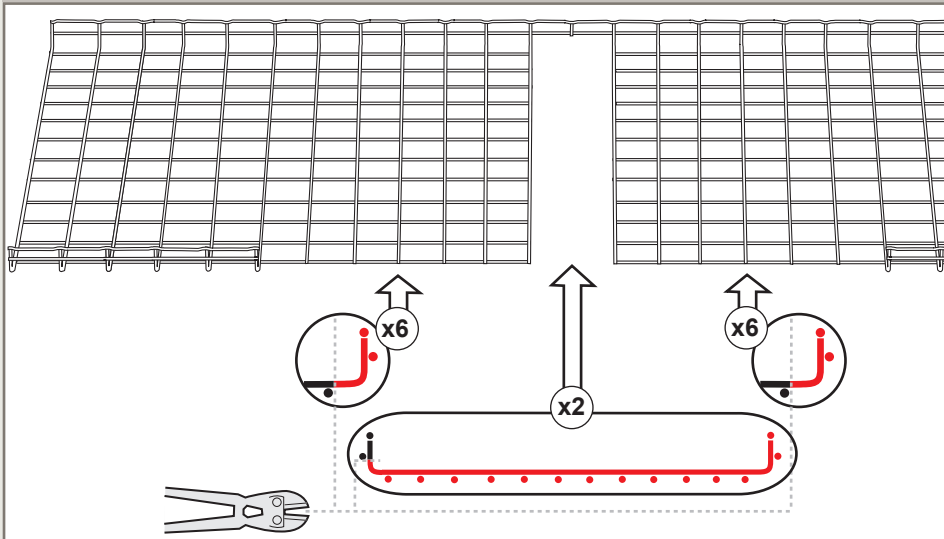

All dimensions (mm) are nominal

→ CE40 : see p. 25

→ Fixing kits : see p. 19



■ Right angle bends

↔ 100 mm

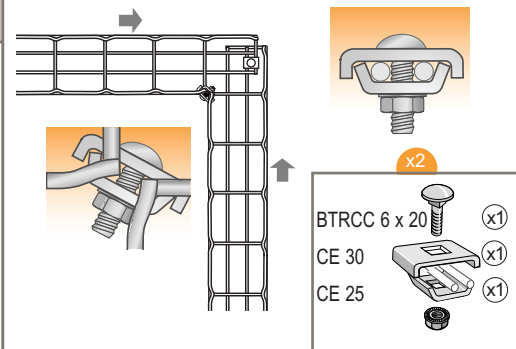
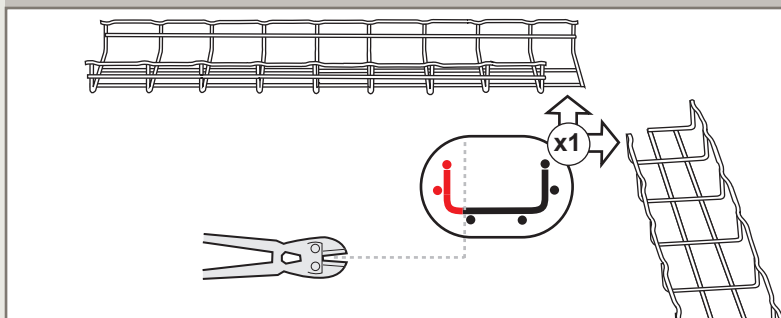

↔ 150 mm

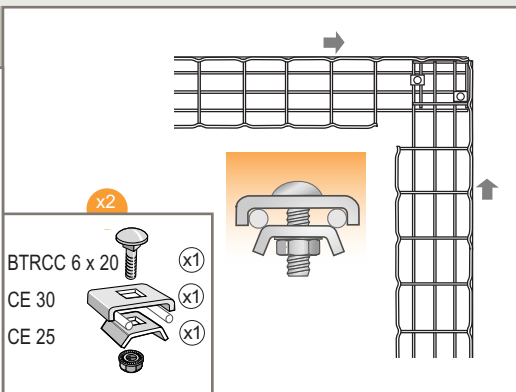
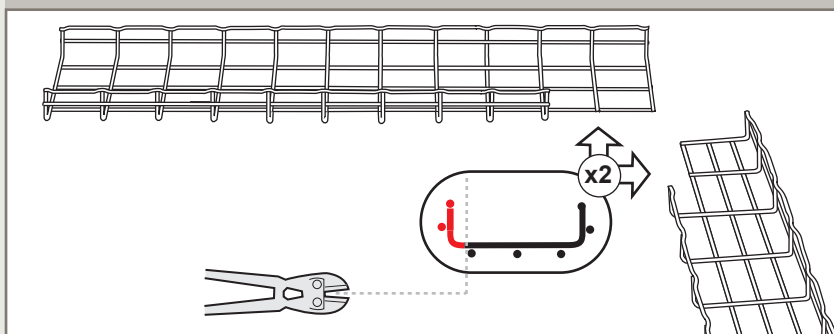

↔ 200 mm

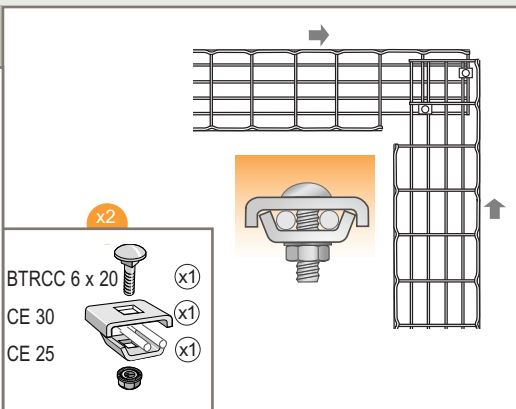
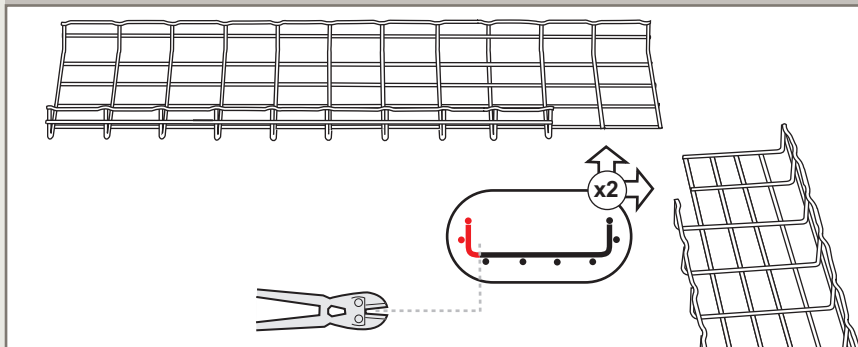

↔ 300 mm

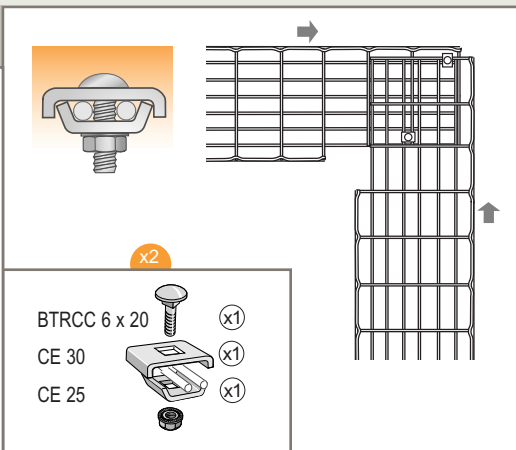
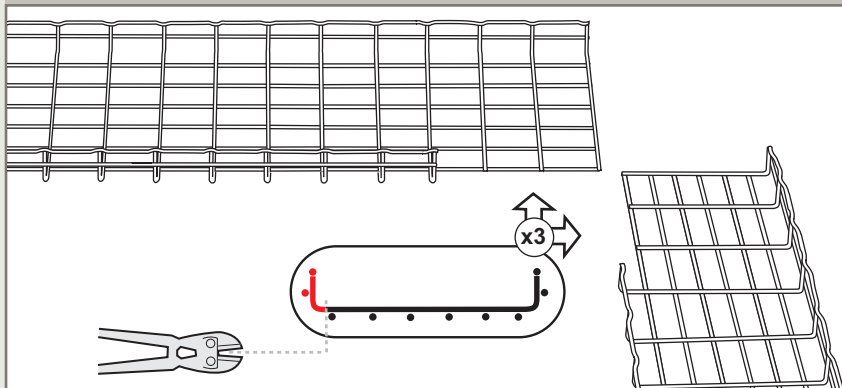

cable tray installation

technical information

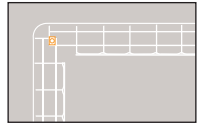

Right angle bends (continued)

400 mm

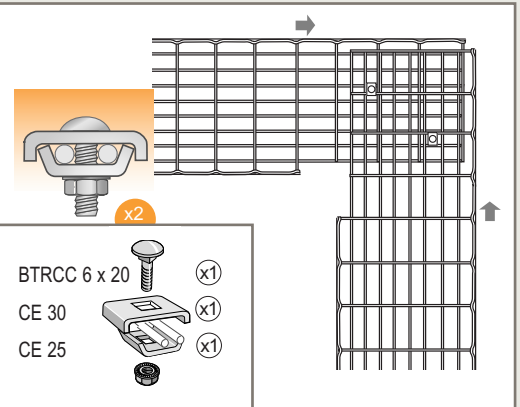
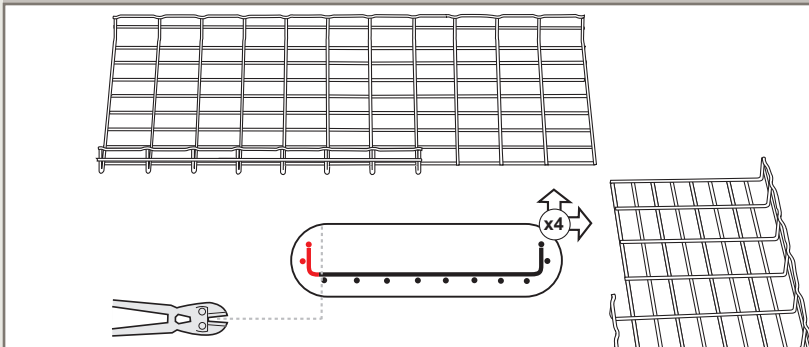

500 mm

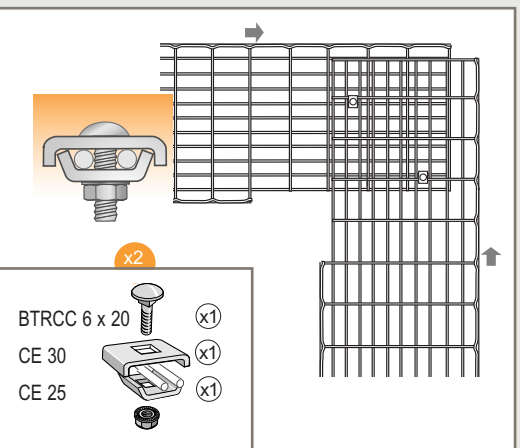
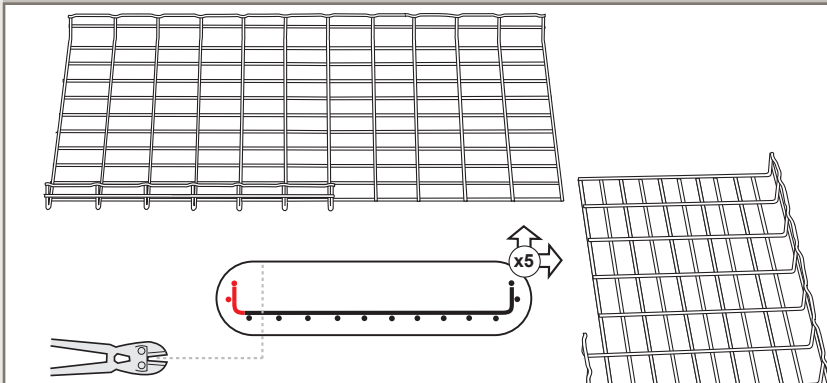

600 mm

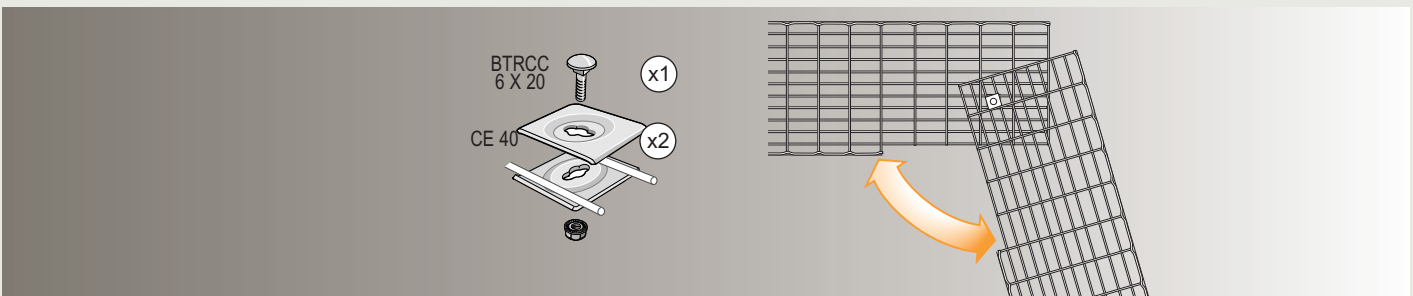
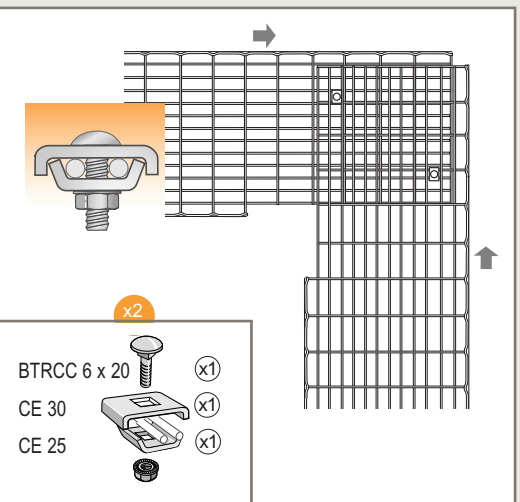
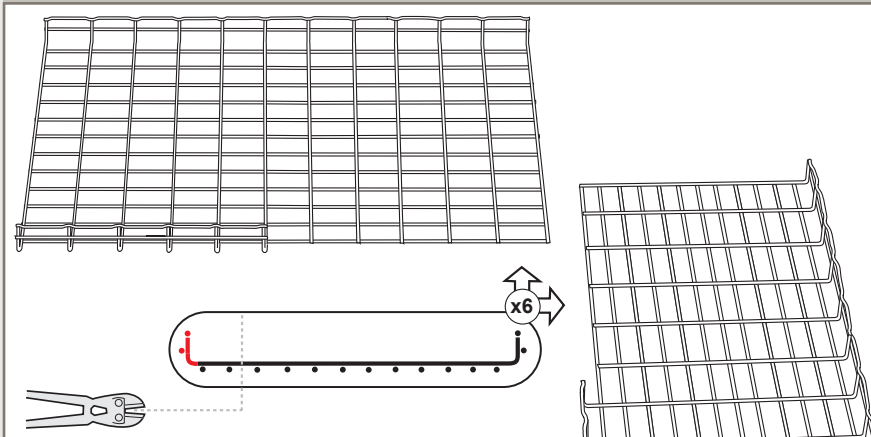

cable tray installation
technical information

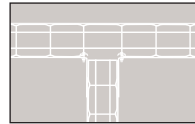

■ T or cross at right angles

↔ 50 mm	<p style="text-align: center;">x1</p>	<table border="1" style="margin-left: auto; margin-right: 0;"> <tr> <td style="text-align: right;">BTRCC 6 x 20</td> <td style="text-align: center;">x2</td> <td style="text-align: center;">x2</td> </tr> <tr> <td style="text-align: right;">CE 25</td> <td style="text-align: center;">x2</td> <td style="text-align: center;">x2</td> </tr> <tr> <td style="text-align: right;">ED 250/90</td> <td style="text-align: center;">x1</td> <td style="text-align: center;">x1</td> </tr> </table>	BTRCC 6 x 20	x2	x2	CE 25	x2	x2	ED 250/90	x1	x1
BTRCC 6 x 20	x2	x2									
CE 25	x2	x2									
ED 250/90	x1	x1									
↔ 100 mm	<p style="text-align: center;">x1</p>	<table border="1" style="margin-left: auto; margin-right: 0;"> <tr> <td style="text-align: right;">BTRCC 6 x 20</td> <td style="text-align: center;">x2</td> <td style="text-align: center;">x2</td> </tr> <tr> <td style="text-align: right;">CE 25</td> <td style="text-align: center;">x2</td> <td style="text-align: center;">x2</td> </tr> <tr> <td style="text-align: right;">ED 250/90</td> <td style="text-align: center;">x1</td> <td style="text-align: center;">x1</td> </tr> </table>	BTRCC 6 x 20	x2	x2	CE 25	x2	x2	ED 250/90	x1	x1
BTRCC 6 x 20	x2	x2									
CE 25	x2	x2									
ED 250/90	x1	x1									
↔ 150 mm	<p style="text-align: center;">x2</p>	<table border="1" style="margin-left: auto; margin-right: 0;"> <tr> <td style="text-align: right;">BTRCC 6 x 20</td> <td style="text-align: center;">x2</td> <td style="text-align: center;">x2</td> </tr> <tr> <td style="text-align: right;">CE 25</td> <td style="text-align: center;">x2</td> <td style="text-align: center;">x2</td> </tr> <tr> <td style="text-align: right;">ED 250/90</td> <td style="text-align: center;">x1</td> <td style="text-align: center;">x1</td> </tr> </table>	BTRCC 6 x 20	x2	x2	CE 25	x2	x2	ED 250/90	x1	x1
BTRCC 6 x 20	x2	x2									
CE 25	x2	x2									
ED 250/90	x1	x1									
↔ 200 mm	<p style="text-align: center;">x2</p>	<table border="1" style="margin-left: auto; margin-right: 0;"> <tr> <td style="text-align: right;">BTRCC 6 x 20</td> <td style="text-align: center;">x2</td> <td style="text-align: center;">x2</td> </tr> <tr> <td style="text-align: right;">CE 25</td> <td style="text-align: center;">x2</td> <td style="text-align: center;">x2</td> </tr> <tr> <td style="text-align: right;">ED 250/90</td> <td style="text-align: center;">x1</td> <td style="text-align: center;">x1</td> </tr> </table>	BTRCC 6 x 20	x2	x2	CE 25	x2	x2	ED 250/90	x1	x1
BTRCC 6 x 20	x2	x2									
CE 25	x2	x2									
ED 250/90	x1	x1									
↔ 300 mm	<p style="text-align: center;">x3</p>	<table border="1" style="margin-left: auto; margin-right: 0;"> <tr> <td style="text-align: right;">BTRCC 6 x 20</td> <td style="text-align: center;">x2</td> <td style="text-align: center;">x2</td> </tr> <tr> <td style="text-align: right;">CE 25</td> <td style="text-align: center;">x2</td> <td style="text-align: center;">x2</td> </tr> <tr> <td style="text-align: right;">ED 250/90</td> <td style="text-align: center;">x1</td> <td style="text-align: center;">x1</td> </tr> </table>	BTRCC 6 x 20	x2	x2	CE 25	x2	x2	ED 250/90	x1	x1
BTRCC 6 x 20	x2	x2									
CE 25	x2	x2									
ED 250/90	x1	x1									

All dimensions (mm) are nominal

→ Fixing kits : see p. 19

cable tray installation

technical information

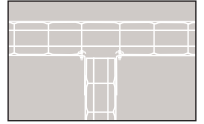

■ T or cross at right angles (continued)

↔ 400 mm

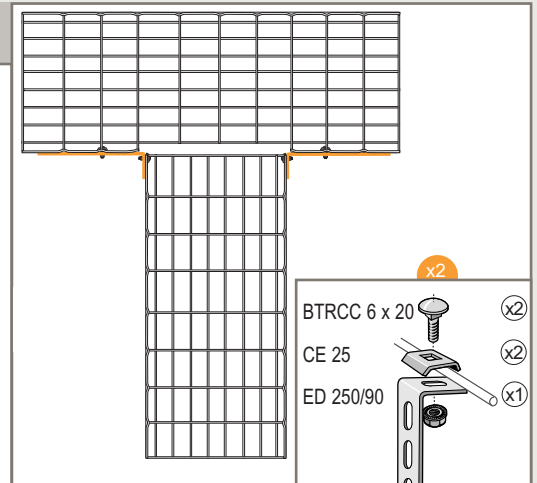
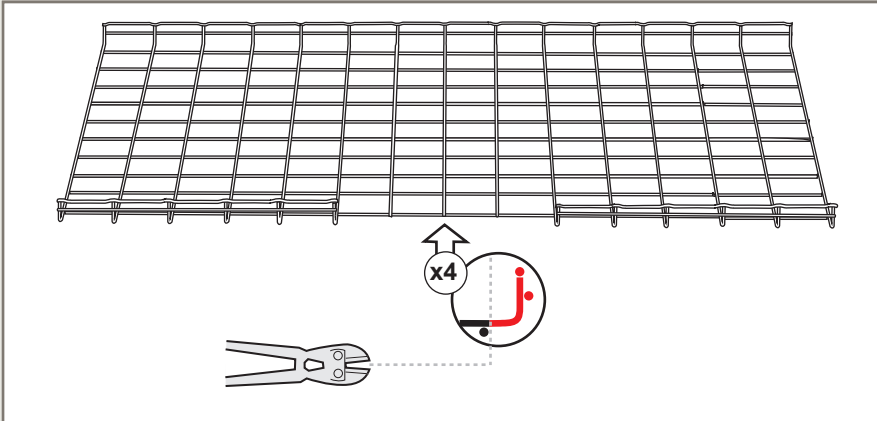

↔ 450 - 500 mm

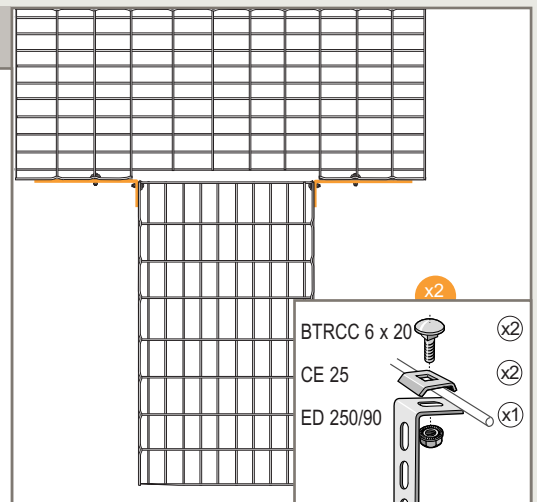
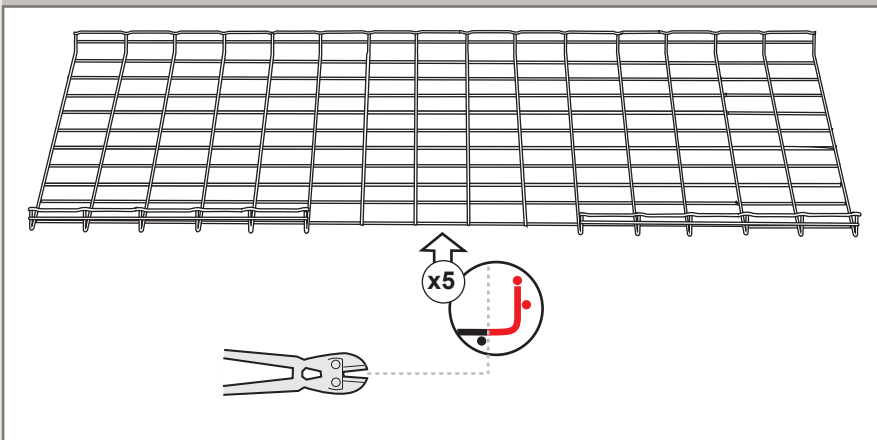

↔ 600 mm

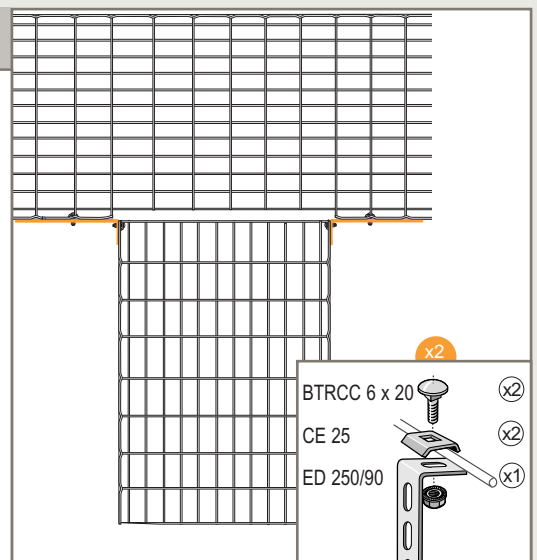
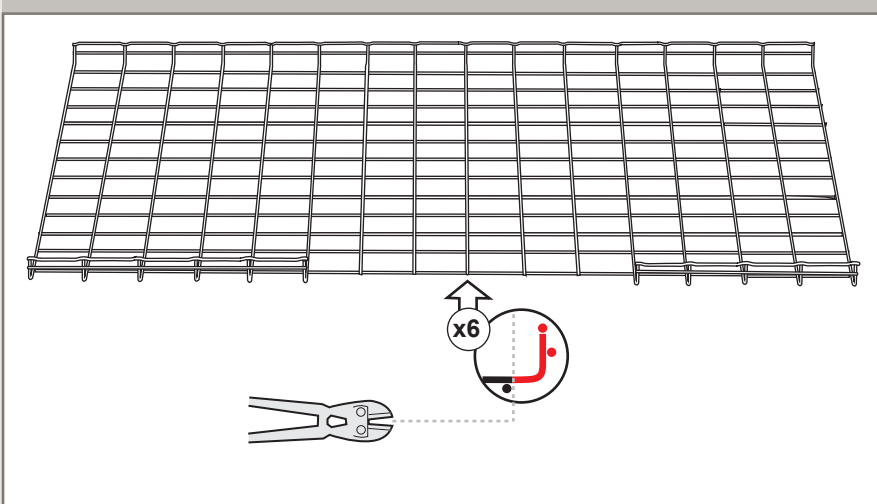

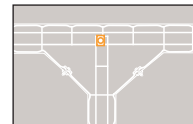

■ T or cross with gusset

↔ 100 mm				<p style="text-align: center;">x3</p> <ul style="list-style-type: none"> BTRCC 6 x 20 (x1) CE 30 (x1) CE 25 (x1)
1				
2		<p style="text-align: center;">x1</p> <ul style="list-style-type: none"> BTRCC 6 x 20 (x1) CE 30 (x1) CE 25 (x1) 		
↔ 150 mm				
1				
2		<p style="text-align: center;">x3</p> <ul style="list-style-type: none"> BTRCC 6 x 20 (x1) CE 30 (x1) CE 25 (x1) 		
↔ 200 mm				
1				
2				

All dimensions (mm) are nominal

cable tray installation

technical information

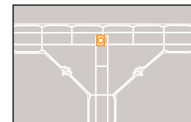

■ T or cross with gusset (continued)

$\overleftrightarrow{\text{mm}}$ 300 - 500 - 600 mm

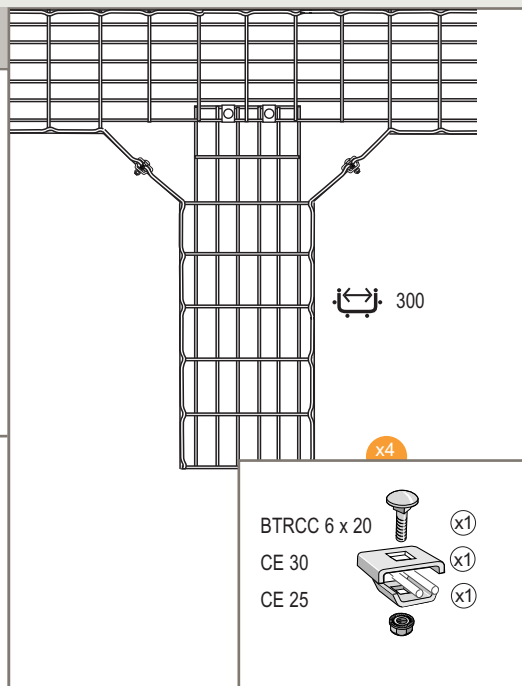
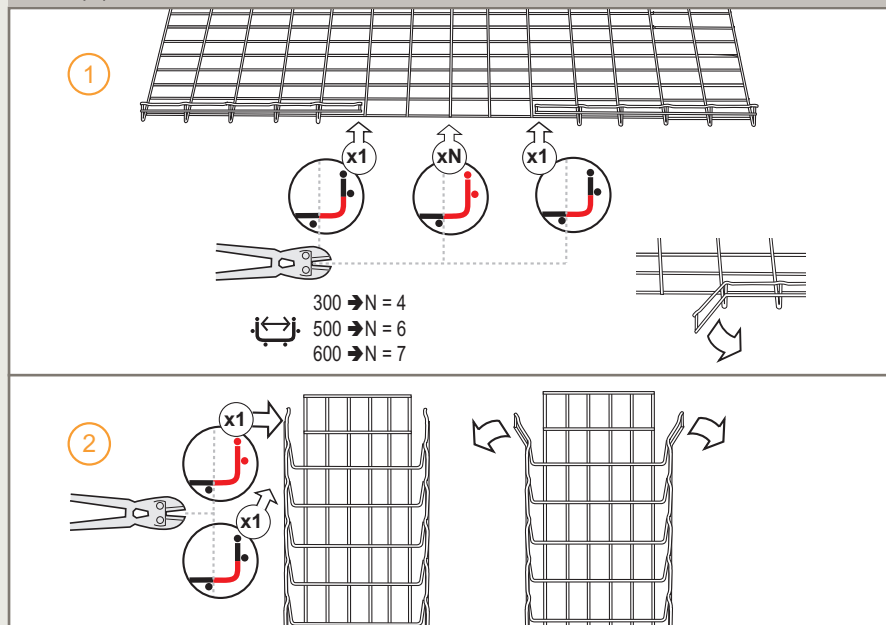

$\overleftrightarrow{\text{mm}}$ 400 mm

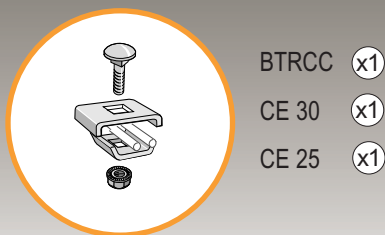
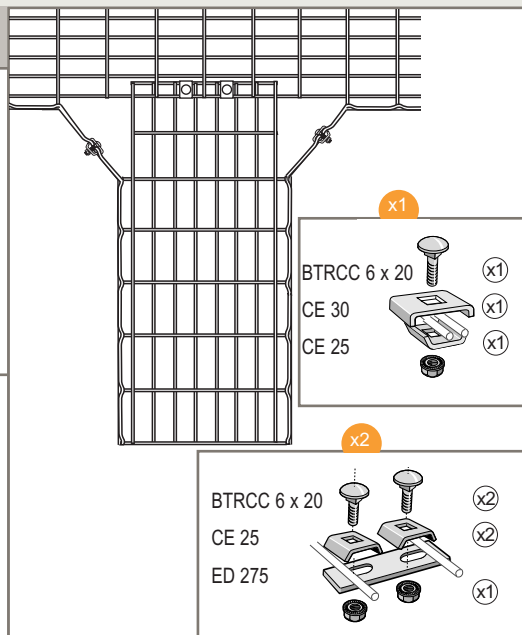
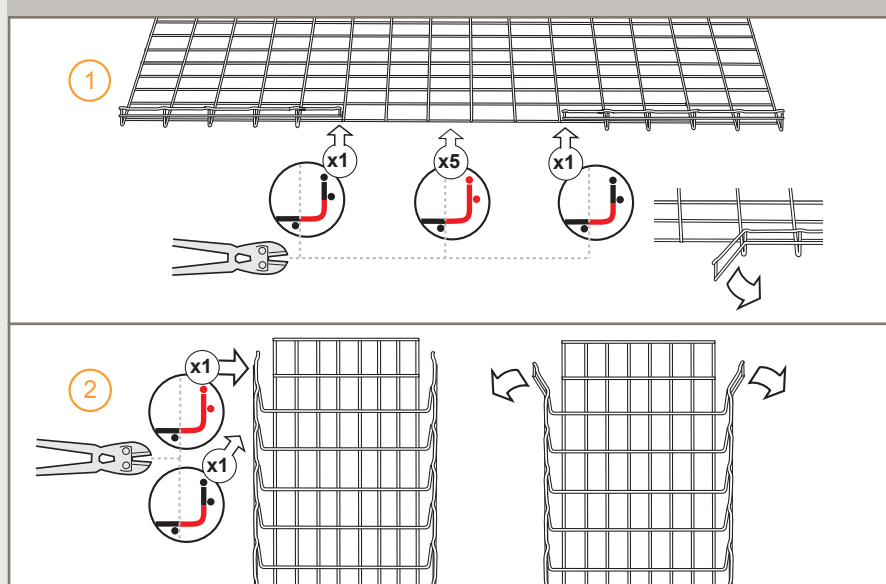

FASLOCK AUTO S $\overleftrightarrow{\text{mm}}$ 100 -> 200 mm
 FASLOCK AUTO XL $\overleftrightarrow{\text{mm}}$ 300 -> 600 mm



■ Reducing size

50 mm

FASLOCK S \rightleftarrows 100 -> 200 mm
 FASLOCK XL \rightleftarrows 300 -> 600 mm
FASLOCK

BTRCC (x1)
 CE 30 (x1)
 CE 25 (x1)

100 mm

BTRCC (x1)
 CE 30 (x1)
 CE 25 (x1)

BTRCC (x2)
 CE 25 (x2)
 ED 275 (x1)

200 mm

BTRCC (x1)
 CE 30 (x1)
 CE 25 (x1)

BTRCC (x2)
 CE 25 (x2)
 ED 275 (x1)

cable tray installation

technical information

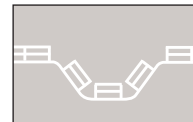

■ Changing level

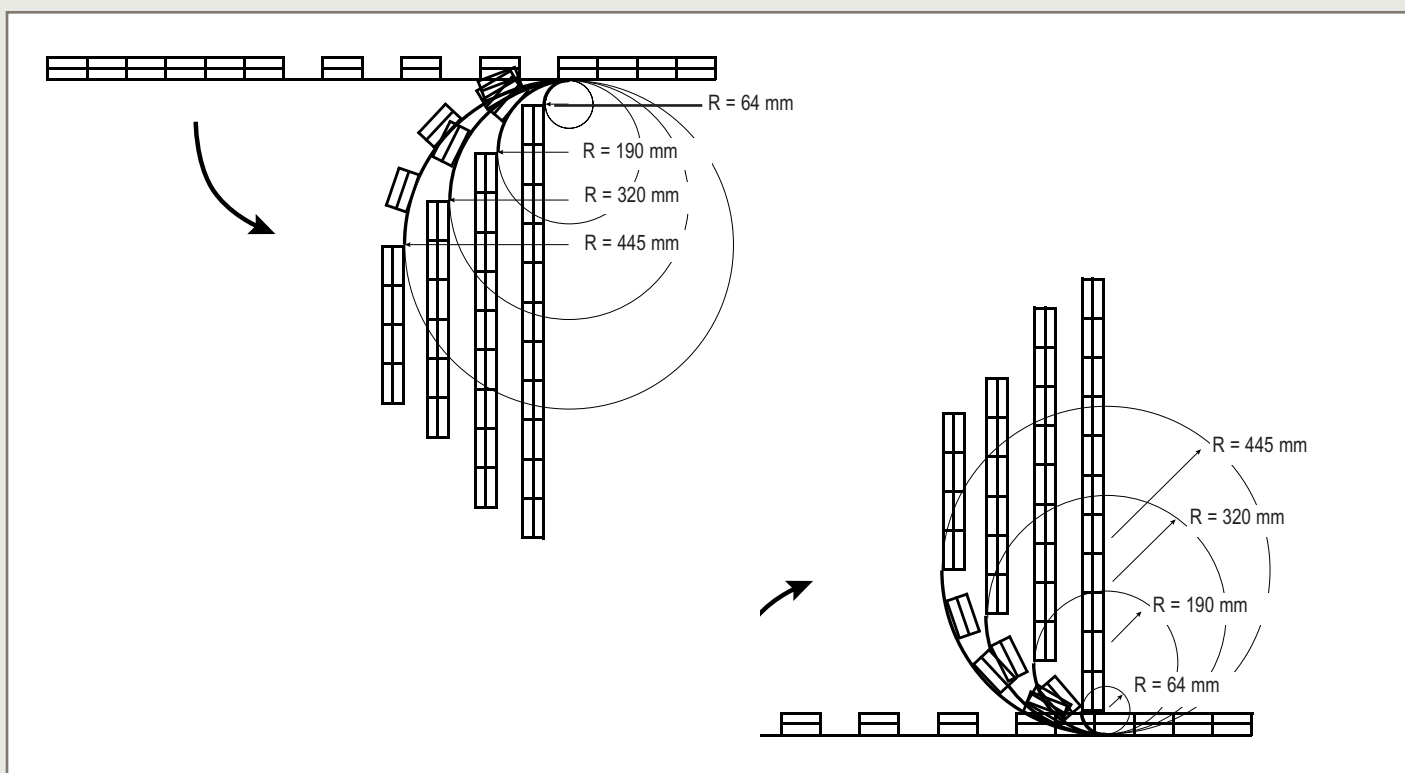
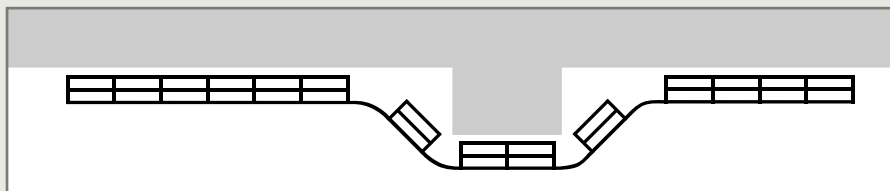
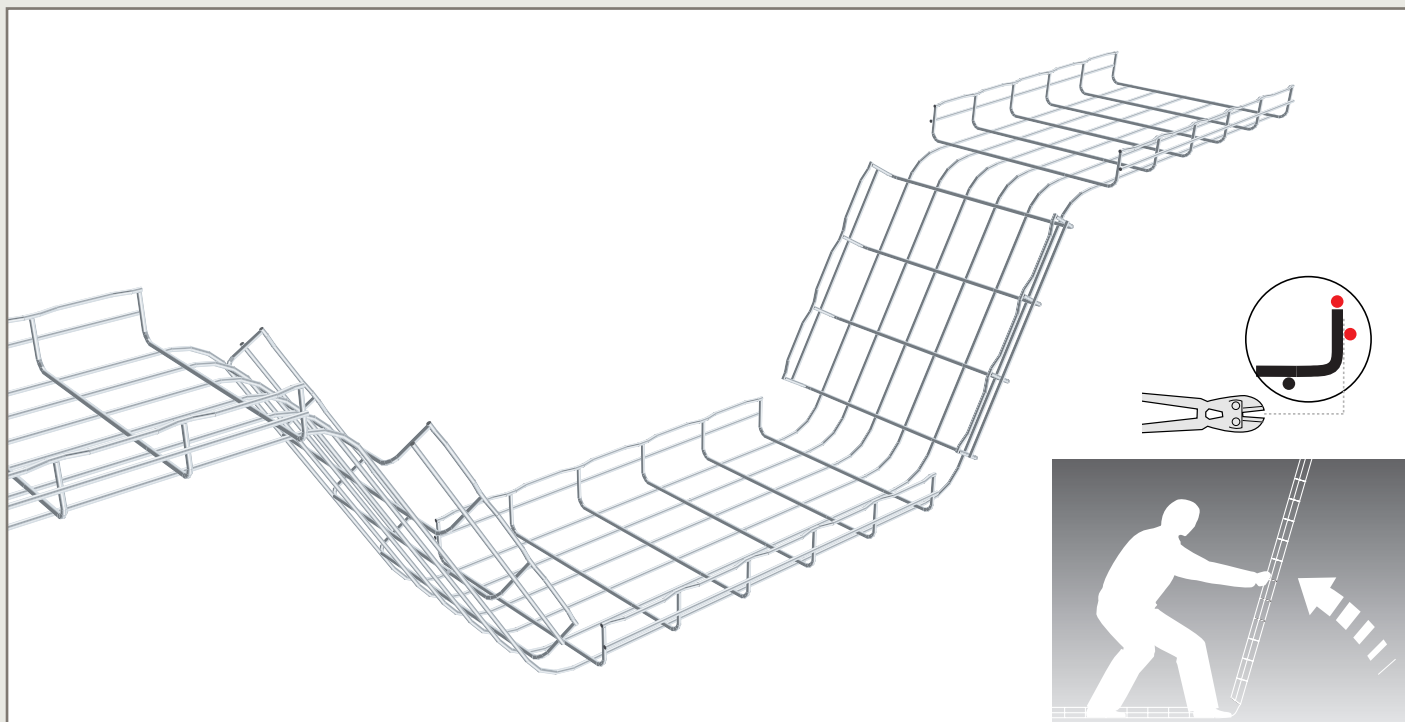

All dimensions (mm) are nominal



design
note

DESIGN NOTES

SELECTING THE RIGHT FINISH

Suitability of finishes	114
Preventing corrosion	114
- Chemical (atmospheric) corrosion	114
- Electrochemical (galvanic) corrosion	114
- The merits of Zinc	115
- Common corrosion situations	115

FINISHES

Coated steels	116
- Pre-galvanised (GS)	116
- Electrogalvanising after manufacture (EZ)	116
- Hot dip galvanised after manufacture (GC)	116
- Geomet (DC)	116
- Organically coated electrogalvanised after manufacture (EZ+)	116
- Continuous galvanisation before manufacture (Z+)	116
Stainless steels	
- Stainless steel (304L)	117
- Stainless steel (316L)	117
Pickling and passivation	117

INSTALLATION OF SERVICES

Design factors to consider	118
- Distributed loads	118
- Point loads	119
- Snow, wind and external forces	119
- Safety factor	119
- Deflection	119
- Spacing of supports	120
- Location of couplers	120
- Installation of cables within a support system	121
- Testing of cables within a support system	122
- Electrical continuity	123
- Earth protection	124
- Electromagnetic compatibility (EMC)	124
Loading graphs	125

FIRE RESISTANCE AND PROTECTION

- Standard DIN 4102-12	126
- Recognised independent laboratories	126
- Test configuration	126
- Samples of configurations tested	127



Selecting the right finish

IN THIS SECTION...

Suitability of finishes

1. Recommended finishes for different environments

Preventing corrosion

1. Chemical (atmospheric) corrosion
2. Electrochemical (galvanic) corrosion
3. The merits of Zinc
4. Common corrosion situations

Suitability of finishes

1 Recommended finishes for different environments

○ Recommended ◆ Possible	GS	EZ	EZ+	GC	DC	304L	316L
Internal installation, normal environment	○	○					
External installation, urban environment	◆	◆	◆	○	○		
Temporary external installation during construction phase	◆	◆	○				
Chemical industries, nitrate explosives, photography, decoration				◆	◆		○
Marine, harsh, sulphurous (weak concentration) environments				◆	◆		○
Acid or alkaline environments		◆		◆	◆	○	◆
Food production environment					○	○	
Halogen environment						◆	○

Typical atmospheric environments in relation to suitability of finishes

Preventing corrosion

In planning any cabling or support installation the choice of an appropriate corrosion resistant finish is always a key issue at the specification stage. The correct choice of finish has long term implications and is crucial for ensuring the longevity (and aesthetics) of the complete installation in order to meet with the client's expectations.

It is vital that the finish specified for the equipment is capable of providing lifetime protection from corrosion within the intended environment - ideally with some margin of safety.

The following pages give information on how corrosion occurs. Contact our technical team on +44 (0) 845 605 5334 for further information.

Corrosion occurs on all metals to some extent. With some, such as stainless steel, its effects



are usually only slight but even then the presence of certain chemicals or physical contact with other metals may cause rapid corrosion. It is therefore important to consider every aspect of the environment surrounding any intended installation in order to choose a material or finish which will minimise the risk of damage to the support system through the effects of corrosion.

1 Chemical (atmospheric) corrosion

Few metals will suffer corrosion damage in a dry, unpolluted atmosphere at a normal ambient temperature. Unfortunately atmospheric pollutants are likely to be present to some degree in most situations where support systems will be installed, thus mild chemical corrosion is normal in almost all situations.

Any support installation which will be situated in an area where higher concentrations of chemicals exist must receive more detailed consideration in order to select a finish which provides the best combination of initial cost and expected life. More detailed information is available upon request, please contact us on +44 (0) 845 605 5334.

2 Electrochemical (galvanic) corrosion

When two dissimilar metals are in contact and become damp it is possible for corrosion to be induced in one of the metals. Such corrosion may progress rapidly and cause considerable damage so it is important to consider and, if necessary, take steps to eliminate this process occurring.

Electrochemical corrosion takes place because the two different metals each behave as electrodes and the moisture as the electrolyte in a simple battery; as with any battery the resulting flow of current will cause corrosion of the anode.

The likely effects of this reaction can be predicted using the Galvanic Series.

Partner metal	Stainless steel	Nickel	Copper	Brass	Tin	Steel	Aluminium	Chromium	Zinc
Stainless steel	0								
Nickel	180								
Copper	320	140							
Brass	400	220	80						
Tin	550	370	230	150					
Steel	750	570	430	350	200				
Aluminium	840	660	520	440	290	90			
Chromium	950	770	630	550	400	200	110		
Zinc	1150	970	830	750	600	400	310	200	0

Differences in potential are expressed in millivolts. Beneath the red line, the metal involved is attacked.

3 The merits of Zinc

The Galvanic Series does show why zinc is such a useful corrosion resistant coating for mild steel.

Firstly, it forms an impervious zinc barrier around the steel, coating it with a metal whose own rate of chemical corrosion is both low and predictable in most situations.

Secondly, if the coating is damaged at any point (e.g. at a cut edge) the zinc surrounding the damaged area becomes the anode of the electrolytic cell and is sacrificially corroded away very slowly in preference to the underlying steel. This ensures the strength of the steel structure remains unaffected.

Because zinc appears near the top of the Galvanic Series it will act as a sacrificial anode in relation to most other metals; thus its relatively low cost and the ease with which it can be applied as a galvanised coating on steel means that it continues to be the most commonly specified protective finish for support systems.

Life expectancy of zinc coatings

The resistance of galvanising to atmospheric corrosion depends on a protective film which forms on the surface of the zinc. When the steel is withdrawn from the galvanising bath the zinc has a clean, bright, shiny surface. Over time the appearance will change to a dull grey patina as the surface reacts with oxygen, water and carbon dioxide in the atmosphere. A complex but tough, stable and protective layer is formed which adheres to the zinc. Contaminants in the atmosphere affect the nature of this protective film.

The most significant contaminant which will accelerate the corrosion rate of zinc is sulphur dioxide (SO₂) and it is the presence of SO₂ which largely controls the atmospheric corrosion of zinc.

The Zinc Millennium Map

The Galvanizers Association has undertaken significant research based upon the positioning of reference canisters placed throughout the UK and the Republic of Ireland to establish background corrosion rates for 10 km² grids which has resulted in the formation of The Zinc Millennium Map.

With the correct use of the map specific locations can be analysed for average zinc corrosion rates per year.

Further information is available at www.galvanizing.org.uk.

4 Common corrosion situations

The most common occurrences of contact between dissimilar metals within support systems are :

- a. Where stainless steel components are being fixed to a carbon steel structure
- b. Where galvanised or zinc plated components are being fixed onto a stainless steel support system

Description of typical atmospheric environments related to the estimation of corrosivity categories

Corrosivity category C. Corrosion rate for zinc (based upon one year exposures), r _{corr} (µm.a ⁻¹) and corrosion level	Typical environments (examples)	
	Indoor	Outdoor
C1 r _{corr} ≤ 0.1 Very low	Heated spaces with low relative humidity and insignificant pollution, e.g. offices, schools, museums	Dry or cold zone, atmospheric environment with very low pollution and time of wetness, e.g. certain deserts, central Arctic / Antarctica
C2 0.1 < r _{corr} ≤ 0.7 Low	Unheated spaces with varying temperature and relative humidity. Low frequency of condensation and low pollution, e.g. storage, sport halls	Temperate zone, atmospheric environment with low pollution (SO ₂ < 5 µg/m ³), e.g.: rural areas, small towns. Dry or cold zone, atmospheric environment with short time of wetness, e.g. deserts, sub-arctic areas
C3 0.7 < r _{corr} ≤ 2 Medium	Spaces with moderate frequency of condensation and moderate pollution from production process, e.g. foodprocessing plants, laundries, breweries, dairies	Temperate zone, atmospheric environment with medium pollution (SO ₂ : 5 µg/m ³ to 30 µg/m ³) or some effect of chlorides, e.g. urban areas, coastal areas with low deposition of chlorides, subtropical and tropical zones with atmosphere with low pollution
C4 2 < r _{corr} ≤ 4 High	Spaces with high frequency of condensation and high pollution from production process, e.g. industrial processing plants, swimming pools	Temperate zone, atmospheric environment with high pollution (SO ₂ : 30 µg/m ³ to 90 µg/m ³) or substantial effect of chlorides, e.g. polluted urban areas, industrial areas, coastal areas without spray of salt water, exposure to strong effect of de-icing salts, subtropical and tropical zones with atmosphere with medium pollution
C5 4 < r _{corr} ≤ 8 Very high	Spaces with very high frequency of condensation and/or with high pollution from production process, e.g. mines, caverns for industrial purposes, unventilated sheds in subtropical and tropical zones	Temperate and subtropical zones, atmospheric environment with very high pollution (SO ₂ : 90 µg/m ³ to 250 µg/m ³) and/or important effect of chlorides, e.g. industrial areas, coastal areas, sheltered positions on coastline
CX 8 < r _{corr} ≤ 25 Extreme	Spaces with almost permanent condensation or extensive periods of exposure to extreme humidity effects and/or with high pollution from production process, e.g. unventilated sheds in humid tropical zones with penetration of outdoor pollution including airborne chlorides and corrosion-stimulating particulate matter	Subtropical and tropical zones (very high time of wetness), atmospheric environment with very high pollution (SO ₂ higher than 250 µg/m ³), including accompanying and production pollution and/or strong effect of chlorides, e.g. extreme industrial areas, coastal and offshore areas with occasional contact with salt spray

Finishes

IN THIS SECTION...

Coated and stainless steels

1. Coated steels
2. Stainless steels

Coated and stainless steels

1 Coated steels

GS Pre-galvanised

EN 10346 (accessories only)

Before manufacture, a coating of zinc is deposited by continuous immersion on to the steel.

EZ Electrogalvanising after manufacture¹

EN 12329 standard

This coating process is often referred to as bright zinc plating (BZP). Electroplating with zinc may be used when a smooth bright decorative finish is required. Parts can be coloured or colourless depending on the type of passivation process used. It is generally used for internal applications where a low degree of corrosion resistance is acceptable. Electroplating involves connecting the metal substrate to a negative terminal of a direct current source and another piece of metal to a positive pole, and immersing both metals in a solution containing ions of the metal to be deposited, in this case zinc.

Ongoing protection

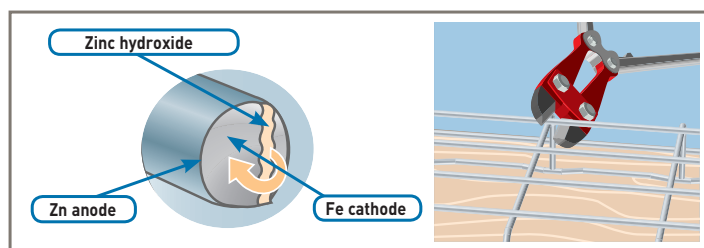

When steel wire cable tray is cut, the level of protection is not affected. The jaws of the bolt cropper drag a layer of zinc across the cut end which forms a protective layer.

GC Hot dip galvanised after manufacture

BS EN ISO 1461 standard

Hot dip galvanising after manufacture is an excellent, economical protective finish used on support systems in many industrial and commercial applications.

Background

The galvanised coating is applied as a final manufacturing process by immersing a steel component (after various pre-treatments) in a large bath of molten zinc; the zinc forms an alloy with the steel substrate and protects the steel from corrosion in two ways.

Firstly, the zinc coating surrounds the base steel with a total, tough physical barrier preventing corrosion of the steel by the surrounding atmosphere. Secondly, if steel does become exposed, e.g. at a cut edge, the zinc coating acts as a sacrificial anode and

will be gradually corroded in preference to the underlying steel. Corrosion products from the zinc will also be deposited onto the steel, effectively re-sealing the surface and maintaining the integrity of the barrier.

NOTE : Any white marks due to the formation of zinc hydroxycarbonate which might appear on the surface have no influence on the corrosion resistance. This is in fact the very principle on which galvanic protection is based.

DC Geomet®

Geomet is a treatment based on zinc and aluminium. As it does not contain any chromium VI (hexavalent), it complies with the RoHS Directive.

Offering protection equivalent to GC, it is used for small accessories and fixings which are difficult to hot dip galvanise.

EZ+ EZ+

EZ+ is an additional organic finish applied over standard electrozinc plated steel wire cable trays, offering a durable surface treatment for temporary external installations during the construction phase.

Cablofil EZ+ brings with it a Class 6 alternative to a hot dip galvanised finish (GC) according to IEC 61537. Salt spray tests carried out demonstrate that EZ+ exceeds the performance of a standard hot dip galvanised finish (no red rust after more than 550 hours exposure to salt spray test, according to ISO 61537). The same 'Class 6' classification is achieved after products are subjected to a simulated 2 year ageing process under UV conditions.

Z+ Z+

Alloy compound of 94% zinc, 3% aluminium and 3% magnesium, coated steel with high elastic yield. Compatible with hot dip galvanised products and has Class 8 properties according to IEC 61537. Products self-regenerate when cut. Z+ products are compatible with hot dip galvanised / EZ+.

Powder coated

Resin-based paint is applied to the steel wire cable tray using an electrostatic powder and then cured in an oven. The entire range of RAL colours can be obtained. Mainly used for aesthetic reasons and to help identify cable routes, it offers very good corrosion resistance.

1: BEAMA 'BEST PRACTICE GUIDE TO CABLE LADDER AND CABLE TRAY INSTALLATIONS'

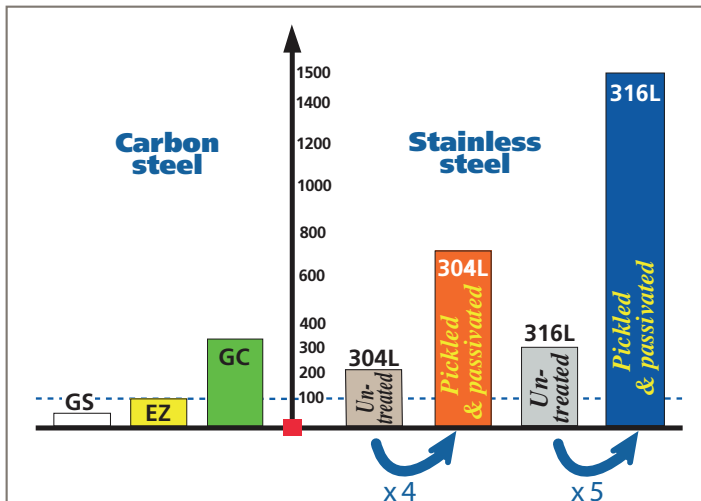

Figures for salt spray tests, baseline 100 hours : EZ

2 Stainless steels

For all practical purposes most stainless steel services supports can be regarded as maintenance free and suffering no corrosion. Inevitably there is a relatively high price to pay for these attractive properties but, in aggressive environments or where the cost or inconvenience of gaining subsequent maintenance access is prohibitive, this initial cost premium may well be justified.

Background

Stainless steel contains a high proportion of chromium (usually at least 17%) and the steel's remarkable immunity to corrosive attack is conferred by the chromium-rich oxide film which occurs naturally on its surface. This invisible film is not only inert and tightly bonded to the surface, it also re-forms quickly if the surface is damaged in any way.

The fire resistance of stainless steel is particularly noteworthy; tests have demonstrated that stainless steel cable supports can be expected to maintain their integrity for considerable periods even when exposed to direct flame temperatures exceeding 1,000°C. This may be an important consideration where the electrical circuits being supported provide for emergency power or control systems.

Stainless steel is also used where hygiene is a major consideration. Its advantages in such applications are again its excellent resistance to the various chemicals and washes which are frequently used for cleaning purposes and the smoothness of surface (depending on the finish specified) which minimises the soiling or contamination that can take place.

304L Stainless steel 304 L

EN 10088-2 standard AISI 304L – X2CrNi18.09 – 1.4307

Offers good corrosion resistance against soft water, normal environments and food products (except mustard and white wine).

316L Stainless steel 316 L

EN 10088-2 standard AISI 316L – X2CrNiMo17.12.2 – 1.4404

Since it contains molybdenum, stainless steel 316L is able to resist intergranular corrosion. This makes it particularly suitable for the chemical and food industries, the nitrate explosives industry and environments containing halogen (fluorine and chlorine).

Pickling and passivation

A stainless steel surface will have excellent corrosion resistance due to the chromium oxide layer on the surface of the product. With some stainless steels however, the surface areas can become subject to corrosion due to the depletion of chromium during welding, or the introduction of iron during a machining process (not applicable to most cable management products). Where a uniform appearance is important after carrying out welding processes, it is often specified that all surfaces should be pickled and passivated to remove the smoke stain from the welding process. Also where extreme corrosion resistance is called for, this process may help to remove crevice corrosion from around the welding area.

Pickling

The pickling process involves the article being immersed in a blend of acids which dissolve iron and iron oxides which adhere to, or are embedded in, the surface of the stainless steel. These acids cause a removal of the surface layer of between 1 and 3 microns. The article is finally rinsed with water to complete this stage of the process.

Passivation

Passivation of the stainless steel will occur naturally after pickling when the oxygen in the air will react with the surface of the steel to form a passive chromium oxide layer. However it is usual for this passivation process to be speeded up by immersing the article in a nitric acid or other passivating agent.



Untreated



Pickled and passivated



Untreated

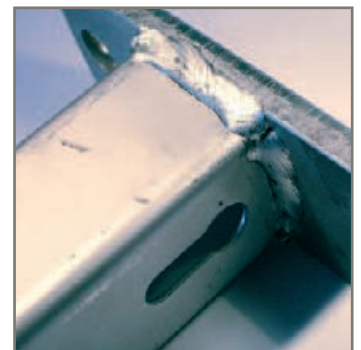

Pickled and passivated

Pickling and passivation gives Cablofil stainless steel wire cable tray a very light grey colour and a distinctly matt finish.

All Cablofil stainless steel products are pickled and passivated.

Installation of services

IN THIS SECTION...

Steel wire cable tray systems

1. Design factors to consider
2. Loadings

Steel wire cable tray systems

Cable tray systems are intended for the support of a combination of cables, electrical equipment and/or communication system installations. Where necessary cable tray systems may be used for the segregation of cables.

Note : these systems are designed for use as supports for cables and not as enclosures giving full mechanical protection.

These systems are covered by BS EN 61537.

1 Design factors to consider

Consideration should be given to the following factors when undertaking the design of a support system although some of these (e.g. snow/wind loads) may not be relevant to every installation.

- (i) **Distributed loads (eg. cables, pipes)**
- (ii) **Point loads**
- (iii) **Snow, wind and external forces**
- (iv) **Safety factor**
- (v) **Deflection**
- (vi) **Spacing of supports**
- (vii) **Location of couplers**
- (viii) **Testing of cables within a support system**
- (ix) **Electrical continuity**
- (x) **Earth protection**
- (xi) **Electromagnetic compatibility (EMC)**

The following sections provide a wealth of useful information on each of these design aspects.

(i) Distributed loads

Before commencing the design process for a new installation it is usual to consider whether future changes in the pattern of demand for building services will impose increased loading requirements on the support system. If so, it is good design practice to allow both the physical space and sufficient load carrying capacity for the future addition of 25% more cables or other loading medium.

Estimation of cable loads

If full details of the cabling layout are available then the likely cable load can be calculated using either manufacturer's published information or the tables of cable weights and diameters which are given opposite. However, it is often necessary to select a tray design in the absence of accurate information on the likely cable load. To assist this selection process a useful approach can be to choose a likely size of tray and then to estimate the maximum cable weight which is capable of being contained within it. This estimate may be arrived at using the following guide :

Max. cabling capacity (kg/m) = cable laying area (m²) x 2800

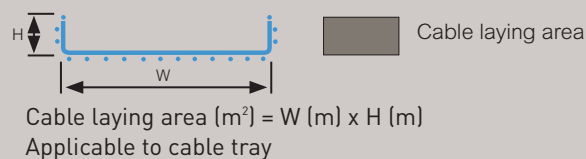

Note : this formula only provides an estimate of the maximum load which can be physically contained within a tray. The ability of that tray to support such a load depends upon the spacing of its supports.

Cable weights and diameters

Tables 1 and 2 below give typical weights and diameters (D) for PVC sheathed, steel wire armoured cables with stranded copper conductors.

Tables 3 and 4 give typical weights and diameters for PVC sheathed, unarmoured stranded copper power cables. Cables with XLPE (cross linked polyethylene) insulation are usually slightly lighter so the information given may also be used for these cables too.

Values show approx. weight and diameter of typical cables.
D = Overall cable diameter.

Table 1 : PVC armoured power/control cables to BS 6346

Nom. area of conductor (mm ²)	2 core		3 core		4 core	
	kg/m	D in mm	kg/m	D in mm	kg/m	D in mm
1.5	0.3	12.3	0.3	12.8	0.4	13.5
2.5	0.4	13.6	0.4	14.1	0.5	15.0
4.0	0.5	15.1	0.5	15.8	0.7	17.8
6.0	0.6	16.5	0.7	18.0	0.9	19.2
10.0	0.9	20.1	1.0	21.2	1.2	22.8
16.0	1.0	21.9	1.2	23.1	1.7	26.3

Table 2 : PVC insulated and sheathed circular surface wiring

Nom. area of conductor (mm ²)	2 core		3 core		4 core	
	kg/m	D in mm	kg/m	D in mm	kg/m	D in mm
1.5	0.1	7.7	0.1	8.2	0.1	9.1
2.5	0.1	9.2	0.2	9.7	0.2	10.6
4.0	0.2	10.2	0.3	11.0	0.3	12.6
6.0	0.2	12.0	0.3	12.8	0.4	14.2
10.0	0.4	14.6	0.5	15.6	0.7	17.4
16.0	0.6	16.9	0.7	18.0	0.9	20.0

Table 3 : PVC unarmoured stranded copper power cables to BS 6346

Nom. area of conductor (mm ²)	2 core		3 core		4 core	
	kg/m	D in mm	kg/m	D in mm	kg/m	D in mm
25	0.7	18.4	1.0	20.4	1.3	22.7
35	0.9	20.0	1.3	22.4	1.7	25.0
50	1.2	22.2	1.7	25.4	2.3	28.6
70	1.7	24.6	2.4	28.4	3.1	32.2
95	2.3	28.2	3.3	33.1	4.3	37.2
120	2.8	30.9	4.0	36.0	5.3	40.6
150	3.5	34.1	4.9	39.7	6.5	45.0
185	4.2	37.8	6.1	44.1	8.0	49.8
240	5.5	43.2	8.0	49.6	10.6	56.2
300	7.0	47.2	9.7	55.0	13.2	62.5
400	8.5	53.2	12.6	61.4	16.7	69.6

Table 4 : PVC armoured stranded copper power cables to BS 6346

Nom. area of conductor (mm ²)	2 core		3 core		4 core	
	kg/m	D in mm	kg/m	D in mm	kg/m	D in mm
25	1.3	23.0	1.7	25.1	2.1	27.5
35	1.6	24.8	2.1	27.3	2.6	30.0
50	2.0	27.2	2.6	30.5	3.5	34.8
70	2.5	29.5	3.6	34.8	4.5	38.4
95	3.5	34.4	4.6	39.1	5.9	43.3
120	4.1	37.1	5.5	41.9	7.5	48.1
150	4.9	40.2	7.0	47.2	8.8	52.3
185	6.3	45.1	8.4	51.4	10.7	57.5
240	7.8	50.5	10.7	57.3	13.5	63.9
300	9.3	55.4	12.7	62.6	16.4	69.9
400	11.3	60.8	15.7	68.8	21.3	78.8

(ii) Point loads

Point loads may consist of permanent equipment, such as lighting luminaires, junction boxes or other switchgear, or temporary loads such as commissioning equipment or installation personnel, however, consider 'safety during the installation phase'.

Analysis of uniformly distributed loads (UDL), such as cables or pipes is relatively simple but analysing the effect of a point load is quite complex; fortunately a simple alternative approach is available.

Firstly, one makes the reasonable assumption that the point load will be situated in the worst position at mid-span. The force this point load imposes can then be taken as equivalent to that imposed by a load of twice its value uniformly distributed along the span. Thus the point load can be converted to the equivalent uniformly distributed load which is then added to other UDLs to produce one total uniform load.

Example:

Point load = 30 kg

Support spacing = 3 m

UDL = 100 kg/m

UDL equivalent to 30 kg point load =

2 x Point Load = 2 x 30 kg = 60 kg = 20 kg/m

Total UDL = 100 kg/m + 20 kg/m = 120 kg/m

The suitability of a tray to carry this total load can then be considered using the loading graph information (see p. 125).

Although this treatment does assume the point load will be in the 'worst case' position, the installer should, given discretion, always position any point load as close as possible both to a support and to either side flange, minimising the stress on the installation, as per the following illustration.

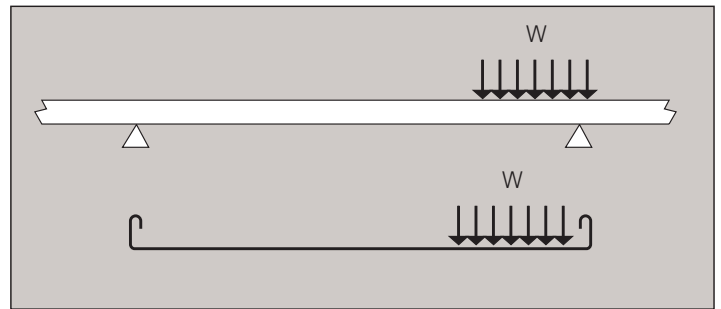

(iii) Snow, wind and external forces

The loading graphs show the maximum safe working steady load for each type of support system. If the system is outdoors and must also sustain snow, ice, wind or other variable forces these must also be taken into account at the design stage.

Appropriate design data for UK weather conditions is given in British Standard BS EN 1991.

(iv) Safety factor

To arrive at a safe working load (SWL) for each type of equipment Legrand test their products to find the ultimate failure load. The SWL is obtained by dividing the load before failure by a factor of 1.7 minimum.

This safety factor may need to be increased by the designer depending upon the circumstances. For example, if the support system is expected to be subject to aggressive abuse a safety factor as high as three or more may be used. Such treatment is, however, the exception and care should be taken not to over-design the system by using an unnecessarily high safety factor.

(v) Deflection

The deflection of a cable tray under load is not directly related to its strength but it is obviously of aesthetic importance. For this reason it may be necessary to estimate the likely deflection whilst designing an installation, especially if it will be in a highly visible location. Experience has shown that in order to maintain a degree of deflection which is subjectively acceptable to the eye, the load on the cable tray will often be restricted to well below its safe maximum.

In the event of critical overload, a steel wire cable tray (wire mesh) structure becomes like a hammock.

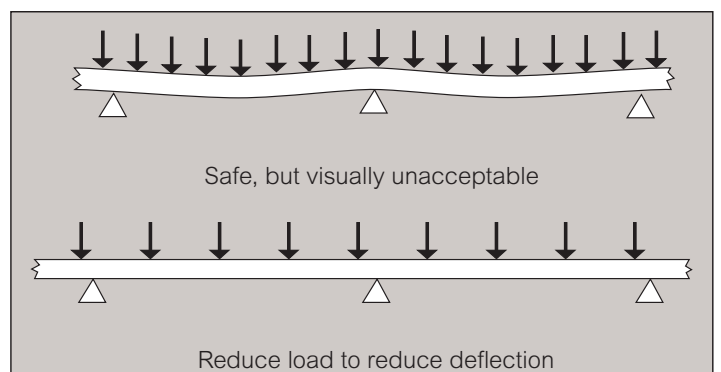

(vi) Spacing of supports

Services support installations are usually considered as multi-span arrangements but it is important to recognise that the loading capability of the system is not uniform from end-to-end. The strength of the two end spans in any run is much lower than that of intermediate spans, even when the ends are rigidly fixed. In many situations the end spans will be more lightly loaded anyway; if however they are not and the installation will be fully loaded from end-to-end then it is recommended that the support spacing of both end spans should be reduced to no more than three quarters that of intermediate spans. However it is not a mandatory requirement, but is both useful and advisable.

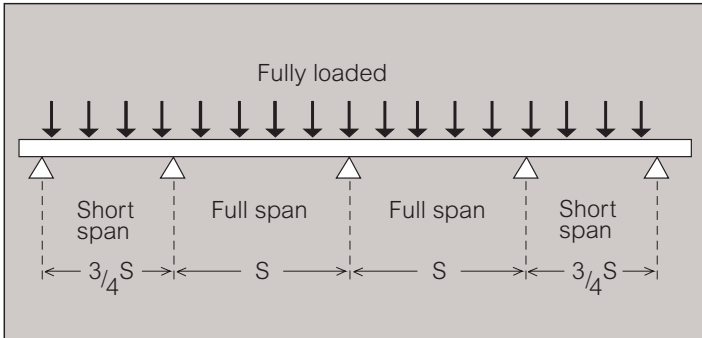

Sometimes the necessary support spacing may be dictated by the nature of the building fabric. If however the designer has discretion over the spacing of supports the loading graphs can be used to maximise this distance. This will reduce the number of support components and fixings that will be required, thus reducing the overall cost of the installed system.

Supports for cable tray (P2000)

Some of the Cablofil steel wire cable tray loading graphs are denoted as P2000. This means setting supports at 2 metre apart instead of 1.5 metres, thus enabling the installer to reduce, a) the number of supports used and b) the overall installation time.

Example:

Span 1500 : $100 \text{ m} / 1.5 = 67$ supports

Span 2000 : $100 \text{ m} / 2 = 50$ supports

Support of fittings

Cable tray fittings must always be provided with local support. The illustrations opposite give recommended support positions.

(vii) Location of couplers

In practice it is often impossible to predetermine where the couplers will be located within a straight run of cable tray. However it is well worth making some effort to roughly plan their position during the early stages of installation.

The worst positions for the couplers is directly underneath a support.

The best position for joints in a continuous installation is one quarter / one fifth of the span distance on either side of each point of support.

Optimum
 100% PERFORMANCE
 For best results, place the couplers at 1/4 or 1/5 of the way along the span

Possible
 70% PERFORMANCE
 If the coupling is at L/2, a coefficient of 0.7 should be applied to the permissible load

Forbidden
 Never put the support under the coupler

Recommended support locations – steel wire cable tray

Positioning of the supports

Changes of level and direction – put supports in place before there is any deflection of the cable tray route.

It is recommended to place supports at the start and end of 90° bends. A support must be positioned in the middle of large-radius bends.

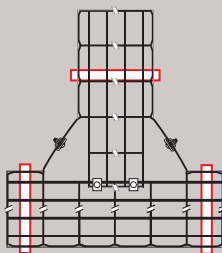
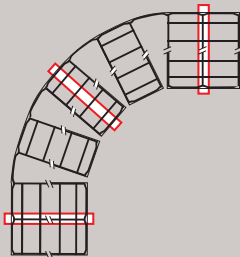
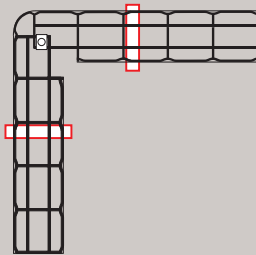
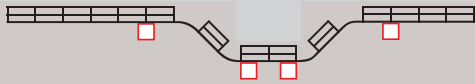

(viii) Testing of cables within a support system

Short circuits

When an electrical short circuit occurs under fault conditions the current that flows can, in some instances, reach tens of thousands of amps and can last from a few milliseconds to several seconds depending on the electrical installation requirements. Such short circuit currents produce high magnetic fields which can interact to produce large mechanical forces. These forces can cause significant displacement of the cables and therefore some form of restraint must be provided to prevent damage to the cables.

For large diameter cables the most common form of restraint is by the use of cable cleats which hold the cables to the steel wire cable tray. Some force may therefore be transferred to the steel wire cable tray via the cable cleat, and could be sufficient to cause damage to the steel wire cable tray.

The calculation of the forces is complex and the effect on a steel wire cable tray system can only be fully determined by testing.

The main causes of short circuits are as follows :

- Damage to insulating material as a result of wear and tear or mechanical impact
- Broken conductors
- Conducting elements falling onto or otherwise coming into contact with the circuit

Short circuit tests

Tests were performed at a recognised independent laboratory (DAMSTRA) and in accordance to standard EN 50368 (2003) - Cable cleats for electrical installations, in order to validate Cablofil steel wire cable tray's mechanical resistance to the stress generated by a short circuit.

An initial short circuit is generated during the tests, creating mutual electromagnetic repulsion between the power cables.

The cable tray is then subjected to substantial mechanical stress for a very short time (approx. one second). The process is repeated in order to demonstrate that Cablofil steel wire cable tray is structurally intact and able to cope with another short circuit.

As a final measure, additional tests are performed in a damp environment to check whether the cables are fully intact.

The various tests are run with 3 successive levels of short circuit current :

- 70 kA, equivalent to a repulsive force of 1 300 daN
- 100 kA, equivalent to a repulsive force of 2 700 daN
- 130 kA, equivalent to a repulsive force of 4 500 daN

Material used : 3 m length of CF105/450, coupled 1/5 of the way along the span, 5 fast couplers and a support span of 1.5 metres.

System configuration : 3 single conductor power cables, 38 mm in diameter, are attached every 600 mm using cleats.



Before test



During test

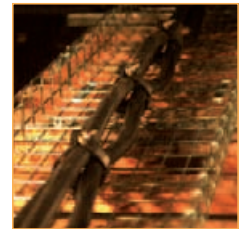

After test

Intensity	Class	
	Class 1	Class 2
70 kA	✓	✓
100 kA	✓	✓
130 kA	✓	✓

Conclusion

The tests reveal that the steel wire cable tray shows no permanent deformation - its mesh structure is able to absorb the physical stress generated by a significant short circuit current.

The cables remain intact in their original positions and network availability is maintained.

Reliability and durability

The two major considerations for the network infrastructures are the reliability and durability of the installation. In order to measure the positive contribution made by Cablofil steel wire cable tray, even when overloaded with cables, a series of independent tests were carried out.

• **Independent tests**

The aim was to develop a detailed understanding of the short-term or long-term benefits of using Cablofil steel wire cable tray, as opposed to conventional flat-bottomed supports, for Cat. 5e and Cat. 6 cables. Cablofil steel wire cable tray lengths were tested by Intertek Testing Services, a division of ETL, the world's leading provider of testing, inspection and certification services.

• **Measurements**

For the two tests described below, parameters relating to cable characteristics (NEXT, FEXT, Attenuation Return Loss, etc.) are measured in different configurations. The main parameter selected for comparison purposes is Return Loss. The aim is to define a cable's impedance regularity. Each irregularity causes the signal to return to its source.

• **Test 1 : reliability under load**

90 metres of Cat. 5e and Cat. 6 cables were tested with no load, before being subjected to mechanical stress equivalent to the weight of 40 cables stacked together. Measuring and comparing the Return Loss for each configuration determines the effect of the support.

Results :

The tests show that, for a Category 5e or Category 6 cable subjected to a load of 40 cables, there is no significant difference in behaviour between Cablofil steel wire cable tray and a support with a flat base.

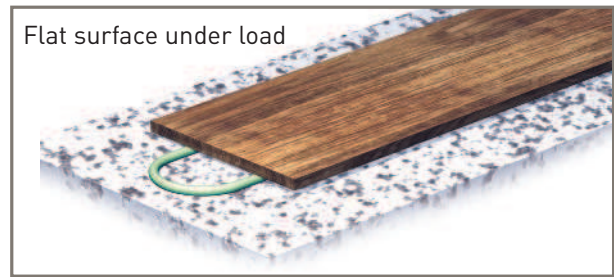
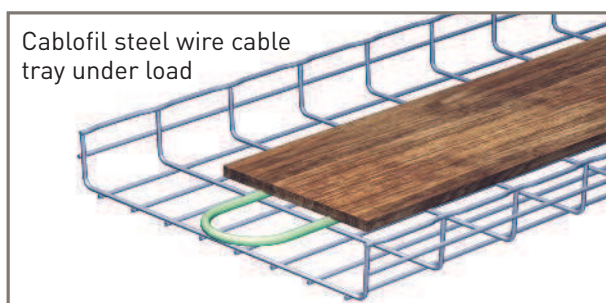
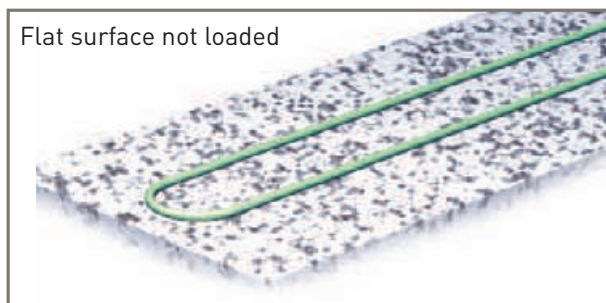
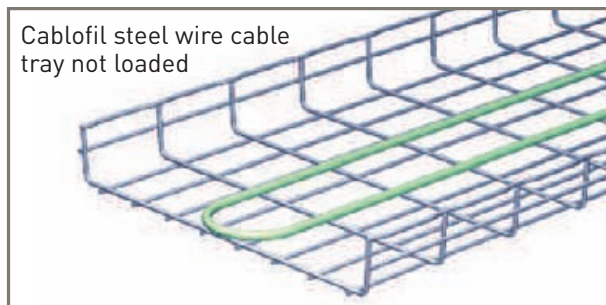

• **Test 2 : durability under load**

In order to establish how data cable installations change over time, the equipment is subjected to a simulated 15 year ageing process based on extremely stringent military standards and the same tests are performed. The cables and supports undergo 200 cycles over large temperature variations (-40°C to +85°C) over a period of 2 weeks.

Results :

The cable supported by Cablofil steel wire cable tray, an open and ventilated system, performs better than a cable laid directly on the floor.

(ix) Electrical continuity

Fundamental to providing safety to people and property, electrical continuity also plays an essential role in the EMC performance of an electrical installation.

Definition

The electrical continuity of a system is its ability to conduct electric current. Each system is characterised by its resistance (R).

If $R = 0 \Omega$, the system is a perfect conductor.

If R is infinite, the system is a perfect insulator.

The lower the system's resistance, the better its electrical continuity will be.

The importance of excellent electrical continuity

Even at the same electrical potential each part of the steel wire cable tray run helps dissipate any fault currents :

Tested for electrical continuity

• **Steel wire cable tray lengths**

Tests show that Cablofil steel wire cable tray lengths more than meet the requirements of the standard IEC 61537, which stipulates that cable tray resistance must not exceed 5 mΩ/m.

• **Steel wire cable tray couplers**

The standard IEC 61537 states that coupler resistance must not exceed 50 mΩ. The test involves running an electric current through the system (lengths + couplers) and measuring coupler resistance.

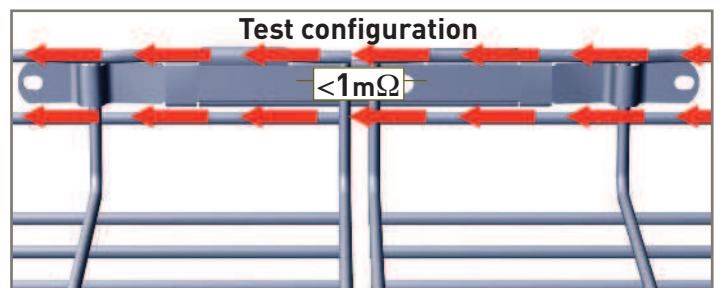

Test results

An average of 0.82 mΩ for Cablofil couplers. This is between 50 and 80 times better than the requirements given in the standard.

All Cablofil couplers are tested and compliant.

Please contact our technical support team on +44 (0)845 605 5334 for the full results of these tests.

(x) Earth protection

Earthing an installation is vital for the safety of people and property. Furthermore it plays an active role in EMC.

Definition

The earth network is made up of all the metallic components of a building that are interconnected. These include beams, conduits, cable management, the metal frames or devices. All such elements must be interconnected to ensure the earth network is equipotential.

Benefits of equipotential earthing network

The equipotential earth network works like a system of conduits evacuating any fault currents and the parasite currents to earth. This provides a means of :

- protecting people and property
- obtaining a satisfactory EMC performance level

Integrating steel wire cable tray into the earth network

In order to benefit from the advantages in terms of safety and EMC, metallic cable trays must be connected to the earth network every 15 m.

Where tray runs are shorter than 15 m, the ends of each metal cable tray must be connected to earth.

Any electrical circuit thus formed by the cable tray must be closed to help remove any fault or noise currents which may arise.

Role of the protective conductor : The protective conductor provides a simple and effective means of connecting the cable tray to earth.

(xi) Electromagnetic compatibility (EMC)

Understanding EMC involves the analysis of electromagnetic pollution between a source of disturbance and its victim.

Definition

Electromagnetic interference is emitted by a source polluting a victim. Electromagnetic interference is transmitted by a process known as coupling. An EMC problem only occurs when the three elements source, coupling and victim are evident. To obtain a good EMC we simply need to eliminate one of the three elements or reduce its effect.

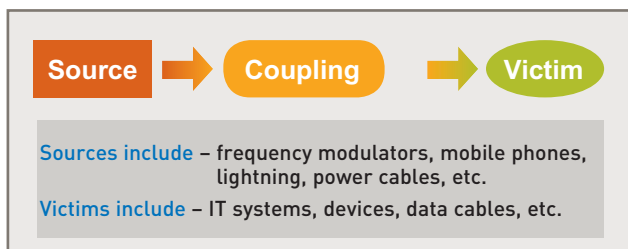

Metallic cable trays with excellent electrical continuity, which are integrated into an installation's equipotential earthing network, reduce the effects of coupling and therefore improve an electrical installation's EMC.

The solution offered by Cablofil steel wire cable tray

- Its open structure makes it easy to ensure correct separation by visual inspection
- Its easy installation and metal structure guarantee excellent electrical continuity in all cases : couplings, bends, changes of level, crossovers etc.
- Its open structure can reduce 'cross talk'

EMC tests

Tests conducted by the accredited and independent AEMC Measures and CETIM laboratories demonstrate the performance of Cablofil steel wire cable tray in relation to the EMC of the electrical installation.

The golden rules!

Remember the importance of keeping power and data cables separate.¹
(EN 50174-2 standard)

Make sure different cable types cross at right angles.

Make sure electrical continuity is preserved : use metal cable tray and couplers.

Connect cable trays to the earthing network (every 15-20 m).

¹ : The EN 50174-2 standard specifies how far cables must be kept apart. This depends on the type of data cable, the number of power cables and the type of cable tray. Otherwise, the distance of 20 cm provides a simple and sensible rule of thumb. For precise details, please contact our technical support team on +44 (0) 845 605 5334.

• Test 1 - configuration:

Data cable in an external electromagnetic field

A data cable (Category 5e UTP) is placed in an insulated anechoic chamber and subjected to a powerful artificially-generated electromagnetic field in order to simulate electromagnetic interference.

Each tray is connected to earth and subjected to the test :

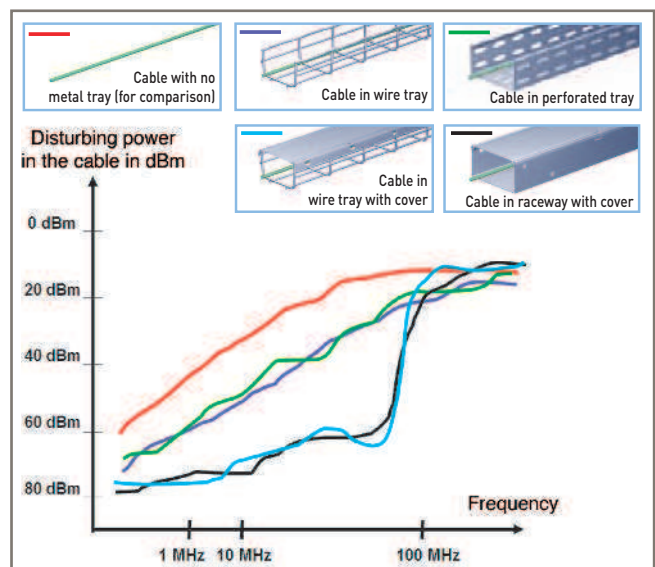

Results and interpretations

A simple comparison of the measurements for the different cable tray configurations - steel wire cable tray (wire mesh) and perforated cable tray, with and without cover - makes it possible to quantify the role played by cable tray in relation to EMC.

These tests show that there is no significant difference in 'Faraday cage' effect offered by steel wire cable tray (wire mesh) or perforated cable tray.

These results show that it is vital :

- to use metal cable tray
- to earth the cable tray
- to use a cover if required

• Test 2 - configuration:

Data cable alongside a power cable

A Category 6 UTP data cable is placed inside an insulated anechoic chamber and subjected to an electromagnetic field generated by a power cable.

The following parameters are studied :

- Cable tray earthing
- Separation distances - 0, 10, 20, 30 cm
- Cable tray type - steel wire cable tray (wire mesh), perforated cable tray, trunking
- Separated cable trays
- One cable trays, with and without dividers

As a result, a total of 118 configurations are tested.

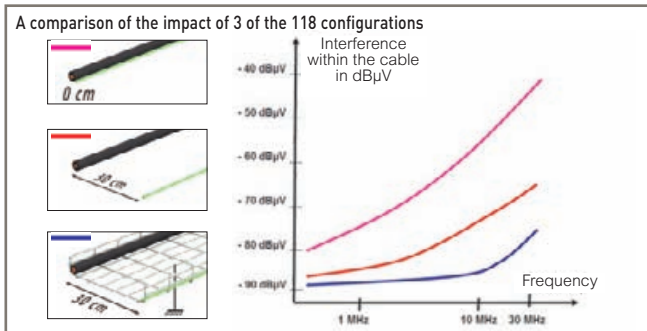
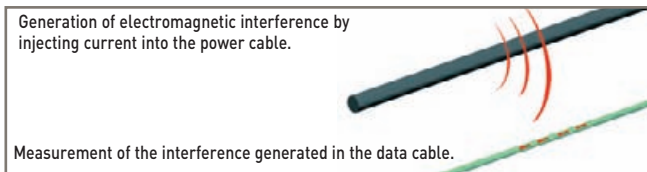

Results and interpretations

This second test configuration confirms that metal cable trays reduce interference - steel wire cable tray (wire mesh) and perforated cable tray.

To obtain a good EMC, these results show that it is vital :

- To use metal cable tray
- To earth the cable tray

2 Loadings

First and foremost, steel wire cable tray must act as an effective, resistant and durable support for cables.

The mechanical performance of all products and accessories is tested against the very demanding requirements imposed by the international standard IEC 61537.

i) Safe working loads

The permissible load stated in this catalogue represents the load that Cablofil steel wire cable tray is guaranteed to be able to bear. It assumes loads are evenly spread and is given in daN/m. The standard permits a deflection equivalent to 1/100th of the span. Legrand imposes a stricter limit of 1/200th for both safety and aesthetic reasons. For example, Legrand voluntarily restricts deflection to 10 mm for a span of 2 m, whereas the standard would allow 20 mm.

Load tests carried out to IEC 61537 (safety factor 1.7 + joint 1/5th of the way along the span). Permissible load should include all cable loads and any other additional loads (eg: wind, snow).

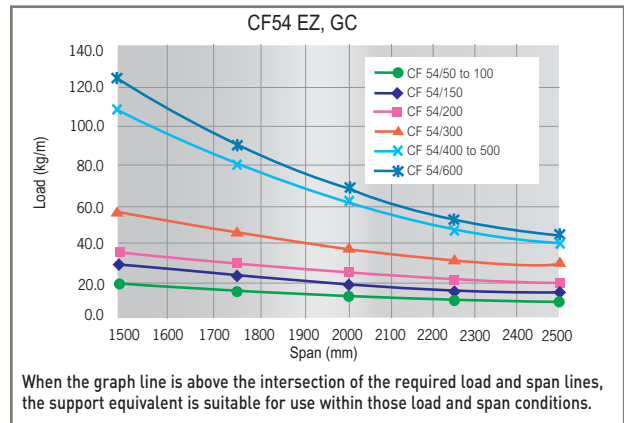

(ii) Safe working loads for supports

Brackets are classified by their permissible load (in daN).

Hangers are classified by their permissible torque (in daN/m).

All Cablofil supports are tested and comply with the IEC 61537 standard.

F - is the load (in daN) applied to the support.

d - is the distance between the hanger axis and the load.

T - is the torque (in daN/m) applied to the hanger.

Calculation rules :

Total F = F₁ + F₂ + F₃ ← permissible hanger load

Total T = F₁.d₁ + F₃.d₃ - F₂.d₂ ← permissible hanger torque

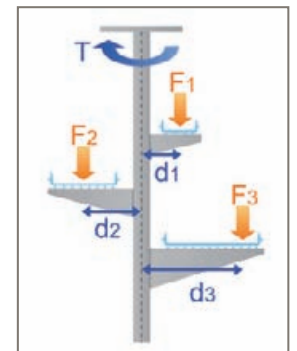

(iii) Load tests : test configuration according to standard IEC 61537

Each Cablofil steel wire cable tray has been tested in the required configuration, with a coupling 1/5th of the way along the span. Deflection is measured at the centre of the span.

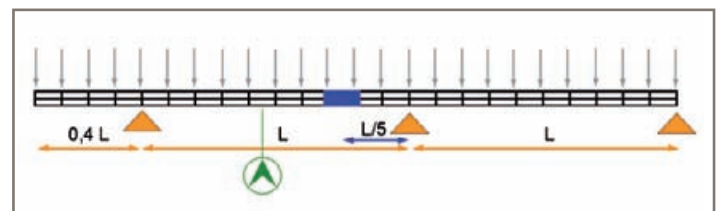

The values given in this document have been obtained from extensive testing of our cable support equipment. They are given as a guide, so that customers may use Legrand's products to the best advantage; they are nevertheless average figures which are given in good faith, but without accepting any liability in contract, tort or otherwise in the event of different performance by equipment which is actually supplied.

Fire resistance and protection

IN THIS SECTION...

Fire resistance

1. Standard DIN 4102-12
2. Recognised independent laboratories
3. Test configuration
4. Samples of configurations tested

Fire resistance

Safety is a major concern for everyone, but can only be achieved with knowledge of how electrical equipment behaves in the event of a fire. Cablofil steel wire cable tray has been successfully tested and proven to meet all fire safety requirements.

1 Standard DIN 4102-12

The German DIN standard serves as a reference. As there is no European standard on fire resistance specifically for cable trays. The German standard specifies that the entire system of cable trays, accessories and cables must be tested in an oven which is at least 3 m long for a period of 30, 60 or 90 minutes at temperatures of up to 1000°C.

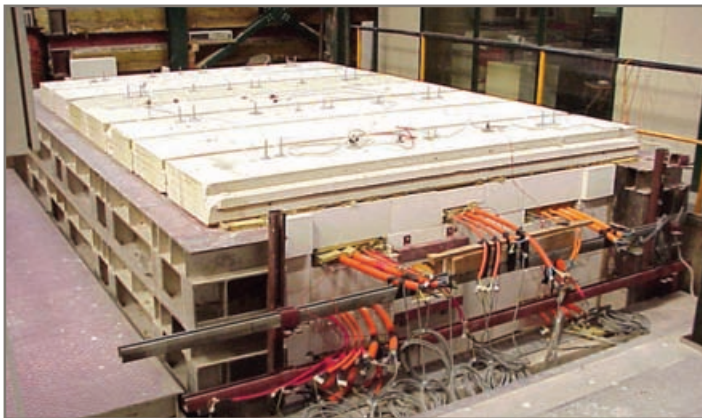

Period	Certification
→ 30 minutes	E 30
→ 60 minutes	E 60
→ 90 minutes	E 90

The test aims to verify whether the electrical system is working properly and make sure that sources of critical data (emergency lighting, ventilators, emergency exit, fire alarm, etc.) can resist long enough to provide assistance in the event of a fire.

2 Recognised independent laboratories

The IBMB (Institut für Baustoffe, Massivbau & Brandschutz) and FIRES laboratories are recognised centres for testing and issuing the associated certificates. They ensure that the test conditions described in the standard DIN 4102-12 are observed.

3 Test configuration

Cablofil steel wire cable tray standard products passed the tests without the need to develop an extensive or specific range. The configurations used by Legrand involve wire cable trays with two different spans (1 250 mm and 1 500 mm) subject to a maximum permissible load of between 2 kg/m and 20 kg/m. The increase in temperature follows the temperature curve (ETK) defined by DIN 4102-12.

The E 90 test does not in itself validate a wire cable tray, but validates the combination of Cablofil steel wire cable tray with a specific type of cable. This underlines the complexity, as well as the relevance, of these tests, which have already been passed by a number of cable types. Cables are tested in pairs.

The surprising appearance of the cable tray after the test is quite normal. The mechanical properties of the cables and cable tray are impaired but they achieved their objective; to ensure the durability of the installation for a given period.

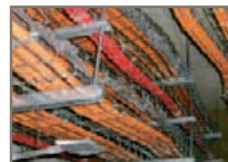
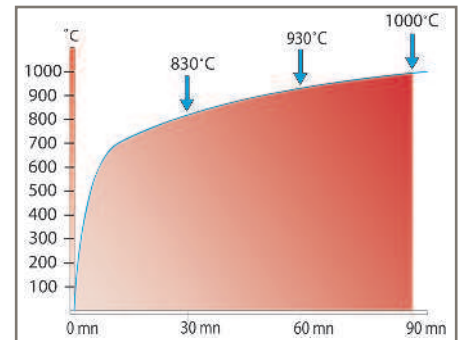

Before test



During test



After test

4 Samples of configurations tested

Cablofil steel wire cable tray is certified to E 90 for a number of configurations that meet the requirements of data transfer facilities designed to ensure the protection of property and people in the event of a fire.

Below are 9 representative samples of the more than 20 configurations tested.

Light duty		
<p>1 200 mm 2 kg/m</p> <p>CF54/50 EZ</p>	<p>1 200 mm 5 kg/m</p> <p>CF54/50 EZ</p>	<p>1 200 mm 5 kg/m</p> <p>CF30/100 EZ</p>
Medium duty		
<p>1 250 mm 10 kg/m</p> <p>CF54/100→200 EZ GC 304L 316L</p>	<p>1 200 mm 1 kg/m to 20 kg/m</p> <p>CF 54/50→400 EZ CF 30/200 EZ</p>	<p>1 250 mm 10 kg/m</p> <p>CF54/100→300 EZ GC 304L 316L</p>
Heavy duty		
<p>1 200 mm 1 kg/m to 20 kg/m</p> <p>CF54/300 EZ CF105/400 EZ</p>	<p>1 250 mm 10 kg/m</p> <p>CF54/150→400 EZ GC 304L 316L</p>	<p>1 250 mm 10 kg/m</p> <p>CF54/100→400 EZ GC 304L 316L</p>

Index

Cablofil references and Legrand Cat. Nos.

Cablofil reference	Cat. Nos.	Finish	Page No.
AS	CM586020	GS	26, 72
AS	6023	DC	-
AS	6024	316L	-
AUTOCLIC	CM558280	GS	18, 48
AUTOCLIC	8283	GC	-
AUTOCLIC	8284	316L	-
AUTOCLIC	8288	304L	-
BLF8/16	CM585387	CU	34, 92
BLF8/35	5397	CU	-
BLF8/50	5407	CU	-
BTRCC 6 x 12	CM801001	EZ	35, 51
BTRCC 6 x 12	1004	316L	35, 51
BTRCC 6 x 12	1007	DC	-
BTRCC 6 x 12	1008	304L	-
BTRCC 6 x 20	1011	EZ	19, 35, 51
BTRCC 6 x 20	1014	316L	-
BTRCC 6 x 20	1017	DC	-
BTRCC 6 x 20	1018	304L	-
BTRCC 6 x 30	1021	EZ	35, 51
BTRCC 6 x 30	1027	DC	-
BTRL 8 x 15	1111	EZ	-
CABLOGRIP	CM559677	-	33, 91
CAT30	CM586050	GS	20, 53
CAT30	6058	304L	-
CAT30	6054	316L	-
CAT30	6057	DC	-
CAT40	6190	GS	20, 31, 54, 87
CAT40	6194	316L	-
CAT40	6197	DC	-
CB50	CM350803	GC	22, 59
CB50	0804	316L	-
CB50	0800	GS	-
CB100	0813	GC	-
CB100	0810	GS	-
CB100	0814	316L	-
CB150	0823	GC	-
CB150	0820	GS	-
CB150	0824	316L	-
CB200/250	0833	GC	-
CB200/250	0830	GS	-
CB200/250	0834	316L	-
CB300	0843	GC	-
CB300	0840	GS	-
CB300	0844	316L	-
CB400	0853	GC	-
CB400	0850	GS	-
CB400	0854	316L	-
CC21S150	CM557860	GS	23, 62
CC21S150	7864	316L	-
CC21S200	7870	GS	-
CC21S200	7874	316L	-
CC21S300	7880	GS	-
CC21S300	7884	316L	-
CC21S400	7890	GS	-
CC21S400	7894	316L	-
CE25	CM558011	EZ	19, 51
CE25	8013	DC	-
CE25	8014	316L	-
CE25	8018	304L	-
CE30	8041	EZ	-
CE30	8043	DC	-
CE30	8044	316L	-
CE30	8048	304L	-
CE40	8051	EZ	25, 69
CE40	8053	DC	-
CE40	8054	316L	-
CE40	8058	304L	-
CEFAS	CM558410	GS	18, 50
CEFAS	8414	316L	-
CEFAS	8417	DC	-
CEQ	CM557300	GS	25, 67
CEQ	7303	GC	-
CEQ	7304	316L	-
CF105/100	CM000891	EZ	13, 42
CF105/100	0893	GC	-
CF105/100	0894	316L	-
CF105/100	0898	304L	-
CF105/150	0901	EZ	-
CF105/150	0903	GC	-
CF105/150	0904	316L	-
CF105/150	0908	304L	-
CF105/200	0911	EZ	-
CF105/200	0913	GC	-
CF105/200	0914	316L	-
CF105/200	0918	304L	-
CF105/300	0921	EZ	-
CF105/300	0923	GC	-
CF105/300	0924	316L	-
CF105/300	0928	304L	-
CF105/400	0931	EZ	-
CF105/400	0933	GC	-
CF105/400	0934	316L	-
CF105/400	0938	304L	-
CF105/450	1931	EZ	-
CF105/450	1933	GC	-
CF105/450	1934	316L	-
CF105/450	1938	304L	-
CF105/500	0941	EZ	-
CF105/500	0943	GC	-
CF105/500	0944	316L	-

Cablofil reference	Cat. Nos.	Finish	Page No.
CF105/500	0948	304L	-
CF105/600	1031	EZ	-
CF105/600	1033	GC	-
CF105/600	1034	316L	-
CF105/600	1038	304L	-
CF150/200	CM000951	EZ	13, 43
CF150/200	0953	GC	-
CF150/300	0961	EZ	-
CF150/300	0963	GC	-
CF150/400	0971	EZ	-
CF150/400	0973	GC	-
CF150/450	1011	EZ	-
CF150/450	1013	GC	-
CF150/500	1021	EZ	-
CF150/500	1023	GC	-
CF30/50	CM000011	EZ	11, 38
CF30/50	0013	GC	-
CF30/50	0014	316L	-
CF30/50	0018	304L	-
CF30/100	0021	EZ	-
CF30/100	0023	GC	-
CF30/100	0024	316L	-
CF30/100	0028	304L	-
CF30/150	0031	EZ	-
CF30/150	0033	GC	-
CF30/150	0034	316L	-
CF30/150	0038	304L	-
CF30/200	0041	EZ	-
CF30/200	0043	GC	-
CF30/200	0044	316L	-
CF30/200	0048	304L	-
CF30/300	0051	EZ	-
CF30/300	0053	GC	-
CF30/300	0054	316L	-
CF30/300	0058	304L	-
CF30/400	0801	EZ	-
CF30/450	0831	EZ	-
CF30/500	0811	EZ	-
CF30/600	0851	EZ	-
CF54/50	CM000061	EZ	11, 39
CF54/50	0062	EZ+	-
CF54/50	0063	GC	-
CF54/50	0064	316L	-
CF54/50	0068	304L	-
CF54/100	0071	EZ	-
CF54/100	0072	EZ+	-
CF54/100	0073	GC	-
CF54/100	0074	316L	-
CF54/100	0078	304L	-
CF54/150	0081	EZ	-
CF54/150	0082	EZ+	-
CF54/150	0083	GC	-
CF54/150	0084	316L	-
CF54/150	0088	304L	-
CF54/200	0091	EZ	-
CF54/200	0092	EZ+	-
CF54/200	0093	GC	-
CF54/200	0094	316L	-
CF54/200	0098	304L	-
CF54/300	0101	EZ	-
CF54/300	0102	EZ+	-
CF54/300	0103	GC	-
CF54/300	0104	316L	-
CF54/300	0108	304L	-
CF54/400	0201	EZ	-
CF54/400	0202	EZ+	-
CF54/400	0203	GC	-
CF54/400	0204	316L	-
CF54/400	0208	304L	-
CF54/450	0251	EZ	-
CF54/450	0252	EZ+	-
CF54/450	0253	GC	-
CF54/450	0254	316L	-
CF54/450	0258	304L	-
CF54/500	0301	EZ	-
CF54/500	0302	EZ+	-
CF54/500	0303	GC	-
CF54/500	0304	316L	-
CF54/500	0308	304L	-
CF54/600	0401	EZ	-
CF54/600	0402	EZ+	-
CF54/600	0403	GC	-
CF54/600	0404	316L	-
CF54/600	0408	304L	-
CF80/100	CM800101	EZ	13, 43
CF80/100	0103	GC	-
CF80/200	0201	EZ	-
CF80/200	0203	GC	-
CF80/300	0301	EZ	-
CF80/300	0303	GC	-
CF80/400	0401	EZ	-
CF80/400	0403	GC	-
CF80/500	0501	EZ	-
CF80/500	0503	GC	-
CFG50/100	CM003221	EZ	14, 44
CFG50/100	3223	GC	-
CFG50/150	3231	EZ	-
CFG50/150	3233	GC	-
CFG50/200	3241	EZ	-
CFG50/200	3243	GC	-

Cablofil reference	Cat. Nos.	Finish	Page No.
CLEEDR	CM558260	EZ	18, 35
CLIPB	CM559177	PLASTIC	33, 91
CLIPG	9197	PLASTIC	-
CLIPJ	9157	PLASTIC	-
CLIPO	9147	PLASTIC	-
CLIPP	9117	PLASTIC	-
CLIPV	9167	PLASTIC	-
CLIPR	9187	PLASTIC	-
CLIPW	9137	PLASTIC	-
CLIPN	9127	PLASTIC	-
CLMFAS	CM559280	GS	29, 83
CLMFAS	9284	316L	-
CLMFAS	9287	Z+	-
CLMU	CM559090	GS	29, 84
CLMU	9097	Z+	-
CLN100	CM556200	GS	23, 62
CLN100	6203	GC	-
CLN150	6210	GS	-
CLN150	6213	GC	-
CLN200	6220	GS	-
CLN200	6223	GC	-
CLN200	6230	GS	-
CLN300	6233	GC	-
CM50	CM586060	GS	20, 31, 55, 87
CM50	6063	GC	-
CM50	6064	316L	-
CM50	6068	304L	-
CM50WL	CM586230	GS	31, 88
CM50WL	6237	Z+	-
CM50XL	CM586130	GS	20, 25, 28, 31, 55, 69, 78, 87
CM50XL	6133	GC	20, 25, 28, 31, 55, 69, 78, 87
CM50XL	6134	316L	20, 25, 28, 31, 55, 69, 78, 87
CM50XL	6138	304L	20, 25, 28, 31, 55, 69, 78, 87
CM50XXL	CM586250	GS	31, 88
CM50XXL	6257	DC	-
COT30	CM923010	GS	16, 46
COT30	3013	GC	-
COT30	3014	316L	-
COT50	3020	GS	-
COT50	3023	GC	-
COT50	3024	316L	-
COT75	3030	GS	-
COT75	3033	GC	-
COT100	3040	GS	-
COT100	3043	GC	-
COT100	3044	316L	-
COTFIL30	CM586711	EZ	16, 46
COTFIL30	6718	304L	-
COTFIL50	6721	EZ	-
COTFIL50	6728	304L	-
COTFIL75	6731	EZ	-
COTFIL75	6738	304L	-
COTFIL100	6741	EZ	-
COTFIL100	6748	304L	-
COTJ	CM923050	GS	16, 46
COTJ	3054	316L	-
COUPEFILGM	CM559507	-	35, 96
CP35	CM755100	GS	15, 45
CP35	5103	GC	-
CP35	5104	316L	-
CP50	CM646010	GS	17, 47
CP50	6013	GC	-
CP50	6014	316L	-
CP100	6020	GS	-
CP100	6023	GC	-
CP100	6024	316L	-
CP150	6030	GS	-
CP150	6033	GC	-
CP150	6034	316L	-
CP200	6040	GS	-
CP200	6043	GC	-
CP200	6044	316L	-
CP300	6050	GS	-
CP300	6053	GC	-
CP300	6054	316L	-
CP400	6060	GS	-
CP400	6063	GC	-
CP400	6064	316L	-
CP450	6090	GS	-
CP450	6093	GC	-
CP450	6094	316L	-
CP500	6070	GS	-
CP500	6073	GC	-
CP500	6074	316L	-
CP600	6080	GS	-
CP600	6083	GC	-
CP600	6084	316L	-
CSN100	CM556100	GS	21, 56
CSN100	6103	GC	-
CSN100	6104	316L	-
CSN100	6108	304L	-
CSN150	CM556110	GS	21, 56
CSN150	6113	GC	-
CSN150	6114	316L	-
CSN150	6118	304L	-
CSN200	6120	GS	-

Cablofil reference	Cat. Nos.	Finish	Page No.
CSN200	6123	GC	-
CSN200	6124	316L	-
CSN200	6128	304L	-
CSN300	6130	GS	-
CSN300	6133	GC	-
CSN300	6134	316L	-
CSN300	6138	304L	-
CSN400	6140	GS	-
CSN400	6143	GC	-
CSN450	6150	GS	-
CSN450	6153	GC	-
CSNC100	CM556300	GS	21, 26, 57, 73
CSNC100	6303	GC	-
CSNC100	6304	316L	-
CSNC150	6310	GS	-
CSNC150	6313	GC	-
CSNC150	6314	316L	-
CSNC200	6320	GS	-
CSNC200	6323	GC	-
CSNC200	6324	316L	-
CSNC300	CM556330	GS	26, 73
CSNC300	6333	GC	-
CSNC400	6340	GS	-
CSNC400	6343	GC	-
CSNC450	6350	GS	-
CSNC450	6353	GC	-
CU500	7460	GS	-
CU500	7463	GC	-
CU500	7464	316L	-
CU600	7470	GS	-
CU600	7473	GC	-
CU600	7474	316L	-
CUTYFIL	CM559549	-	35, 96
CVN50	CM629050	GS	17, 47
CVN50	9053	GC	-
CVN50	9054	316L	-
CVN50	9058	304L	-
CVN100	9100	GS	-
CVN100	9103	GC	-
CVN100	9104	316L	-
CVN100	9108	304L	-
CVN150	9150	GS	-
CVN150	9153	GC	-
CVN150	9154	316L	-
CVN200	9200	GS	-
CVN200	9203	GC	-
CVN200	9204	316L	-
CVN300	9300	GS	-
CVN300	9303	GC	-
CVN400	9400	GS	-
CVN400	9403	GC	-
CVN450	9450	GS	-
CVN450	9453	GC	-
CVN500	9500	GS	-
CVN500	9503	GC	-
CVN600	9600	GS	-
CVN600	9603	GC	-
DEV100	CM585160	GS	33, 90
DEV100	5164	316L	-
DEV100	5167	Z+	-
ED275	CM558221	EZ	18, 49
ED275	8223	GC	-
ED275	8224	316L	-
ED275	8228	304L	-
ED1100	CM558201	EZ	18, 49
ED1100	8203	GC	-
ED1100	8204	316L	-
EDF600	CM557610	GS	24, 58-61
EDF600	7613	GC	-
EDF1000	CM561090	GS	24, 58-61
EDF1000	1093	GC	-
EDF2000	CM561010	GS	24, 27, 58-61
EDF2000	1013	GC	-
EDF2000	1014	316L	-
EDF2000	1018	304L	-
EDF3000	1020	GS	24, 58-61
EDF3000	1023	GC	-
EDRN	CM558241	EZ	18, 48
EDRN	8244	316L	-
EDRN	8247	DC	-
EEC6	CM801201	EZ	35, 51
EEC6	1204	316L	-
EEC8	1211	EZ	-
EF400	CM559201	EZ	29, 85
EF600	9211	EZ	-
EPVCSN	CM559605	PVC	21, 56
EXSBD	CM585130	GS	30, 86
EXT-SCF50	CM586810	GS	26, 70
EXT-SCF100	6820	GS	-
EXT-SCF150	6830	GS	-
EXT-SCF325	6840	GS	-
F01	CM646220	GS	17, 47
F01	6224	316L	-
F02	6200	GS	-
F02	6204	316L	-
F03	6210	GS	-
F03	6214	316L	-
FAS ROLLER	CM011100	GS	33, 90
FASLOCK AUTO S	CM558340	EZ	18, 49
FASLOCK AUTO S	8344	316L	-
FASLOCK AUTO S	8347	DC	-
FASLOCK AUTO XL	8320	EZ	-
FASLOCK AUTO XL	8324	316L	-
FASLOCK AUTO XL	8327	DC	-
FASTRUT41	CM599004	316L	18, 51

Cablofil reference	Cat. Nos.	Finish	Page No.
FASTRUT41	9007	DC	-
FCF54/50	CM081064	316L	12, 41
FCF54/50	1068	304L	-
FCF54/100	1074	316L	-
FCF54/100	1078	304L	-
FCF54/150	1084	316L	-
FCF54/150	1088	304L	-
FCF54/200	1094	316L	-
FCF54/200	1098	304L	-
FCF54/300	1104	316L	-
FCF54/300	1108	304L	-
FCF54/400	1204	316L	-
FCF54/400	1208	304L	-
FCF54/450	CM081254	316L	-
FCF54/450	1258	304L	-
FCF54/500	1304	316L	-
FCF54/500	1308	304L	-
FCF54/600	1404	316L	-
FCF54/600	1408	304L	-
FCFA54/50	CM082061	EZ	12, 40
FCFA54/100	2071	EZ	-
FCFA54/150	2081	EZ	-
FCFA54/200	2091	EZ	-
FCFA54/300	2101	EZ	-
FCFA54/400	2201	EZ	-
FCFA54/450	2251	EZ	-
FCFA54/500	2301	EZ	-
FCFA54/600	2401	EZ	-
FTX	CM586180	GS	15, 29, 45, 80
FTX	6183	DC	-
FTX	6184	316L	-
FV1	6070	GS	23, 64
FV1	6073	DC	-
FV1	6074	316L	-
G-MINI	CM430111	EZ	15, 45
G-MINI	0114	316L	-
GRIFEQUIP	CM585327	AL	34, 93
GRIFEQUIP 2	5427	AL	-
INTERFAS	CM557800	GS	24, 56
INTERFAS	7803	DC	-
KITASSTR	CM558081	EZ	19, 51
KITASSTR	8084	316L	-
KITASSTR	8087	DC	-
KITASSVS	8071	EZ	-
KITASSVS	8077	DC	-
KITFIXTR	CM558091	EZ	-
KITFIXVS	8061	EZ	-
KITINOX	8954	316L	19, 51
MFM100	CM585140	GS	32, 89
MFM100	5143	Z+	-
MFM100	85144	316L	-
MFM150	85150	GS	-
MFM150	85153	Z+	-
MPPOLYA	CM585145	POLYA	32, 89
PA1	CM840101	EZ	33, 92
PA1	0103	GC	-
PA2	0111	EZ	-
PA2	0113	GC	-
PA4	0131	EZ	-
PA4	0133	GC	-
PFR41S	CM595380	GS	27, 77
PFREDF	CM561080	GS	27, 76
PFREDF	1084	316L	-
PFSCF	CM586210	GS	26, 70
R15/100	CM586173	Z+	18, 23, 28, 50, 63, 79
R15/100	6174	316L	-
R15/100	6170	GS	-
R15/300	6610	GS	-
R15/300	6617	Z+	-
R25	CM586640	GS	18, 23, 28, 50, 63, 79
R25	6647	Z+	-
R35	6650	GS	-
R35	6657	Z+	-
R55	6080	GS	23, 28, 63
R55	6083	Z+	-
R55	6084	316L	-
RCSN150	CM013150	GS	24, 27, 28, 65, 71, 74, 78, 82-83
RCSN150	3153	GC	-
RCSN150	3154	316L	-
RCSN200	3200	GS	-
RCSN200	3203	GC	-
RCSN200	3204	316L	-
RCSN300	3300	GS	-
RCSN300	CM013303	GC	24, 27, 28, 65, 71, 74, 78, 82-83
RCSN300	3304	316L	-
RCSN400	3400	GS	-
RCSN400	3403	GC	-
RCSN400	3404	316L	-
RCSN500	3500	GS	-
RCSN500	3503	GC	-
RCSN500	3504	316L	-
RCSN550	3550	GS	-
RCSN550	3553	GC	-
RCSN600	3600	GS	-
RCSN600	3603	GC	-
RCSN600	3604	316L	-
RCSN1000	3010	GS	-
RCSN1000	3013	GC	-
RCSN1000	3014	316L	-
RCSN2000	3020	GS	-
RCSN2000	3023	GC	-
RCSN2000	3024	316L	-
RCSN2000	3028	304L	-

Cablofil reference	Cat. Nos.	Finish	Page No.
RCSN3000	3030	GS	-
RCSN3000	3033	GC	-
RCSN3000	3034	316L	-
RCSN3000	3038	304L	-
RE41SP500	CM595750	GS	24, 27, 60-61, 77
RE41SP800	5780	GS	-
RE41SP1000	5790	GS	-
RE41SP3000	5700	GS	-
SAS	CM586031	EZ	25, 68
SAS	6037	DC	-
SBD	CM585110	GS	30, 86
SBD	5114	316L	-
SBDN	CM585410	GS	30, 86
SBDN	5417	Z+	-
SCF200	CM586200	GS	26, 70
SCF300	6300	GS	-
SCF400	6400	GS	-
SCF450	6450	GS	-
SCF500	6500	GS	-
SCF600	6600	GS	-
SF100	CM586100	GS	25, 66
SF100	6103	GC	-
SF100	6104	316L	-
SF50	CM586140	GS	25, 66
SF50	6143	GC	-
SF50	6144	316L	-
SL100	CM585190	GS	32, 89
SL50	CM585180	GS	25, 32, 66, 89
TXF35	CM756001	EZ	15, 45
TXF35	5003	GC	-
TXF35	5004	316L	-
TXF35	5008	304L	-
UC35	CM586160	GS	15, 45
UC35	6163	GC	-
UC35	6164	316L	-
UC50	CM586040	GS	20, 25, 29, 52, 67, 80
UC50	6043	GC	-
UC50	6044	316L	-
UC50	6048	304L	-
UCS	CM586150	GS	26, 71
UCS	6153	GC	-
UCS	6154	316L	-
UF30/300	CM430161	EZ	14, 44
UF30/400	0181	EZ	-
UF30/500	0201	EZ	-
UFC	CM559220	GS	29, 81-82
Flat washers			
M6	FW06	EZ	35
M8	FW08	EZ	-
M10	FW10	EZ	-
M12	FW12	EZ	-
Hexagon nuts			
M6	HN06	EZ	35
M8	HN08	EZ	-
M10	HN10	EZ	-
M12	HN12	EZ	-
Threaded rod			
M6	TR06	EZ	35
M8	TR08	EZ	-
M10	TR10	EZ	-
M12	TR12	EZ	-

 For index arranged by Legrand Cat. Nos. visit legrand.co.uk to download the PDF.

Conditions of sale
please consult our current price list

In accordance with its policy of continuous improvement, the Company reserves the right to change specifications and designs without notice. All illustrations, descriptions, dimensions and weights in this catalogue are for guidance and cannot be held binding on the Company.
All contents and design presentation included in this publication are © Legrand Electric Limited. All rights reserved. 2014

Contact details

United Kingdom

Great King Street North,
Birmingham, B19 2LF

Customer Services:

Tel: +44 (0) 845 605 4333 Fax: +44 (0) 845 605 4334
E-mail: legrand.sales@legrand.co.uk

Quotations and Technical Support:

Tel: +44 (0) 870 608 9020 Fax: +44 (0) 845 605 5334
E-mail: uk-cmsales@legrand.co.uk

Republic of Ireland:

Tel: 01 295 9673 Fax: 01 295 4671
E-mail: legrand.sales@legrand.co.uk



FOLLOW
US AT

@ www.legrand.co.uk
www.legrand.ie

 www.youtube.com/legrandtvuk

 www.twitter.com/legranduk

 www.votimum.co.uk
www.votimum.ie

Distributor:



Head office (UK and Ireland):
Legrand Electric Limited
Great King Street North, Birmingham, B19 2LF
Tel: +44 (0) 870 608 9000 Fax: +44 (0) 870 608 9004
Website: www.legrand.co.uk



This document is printed on sustainably sourced paper. Please recycle.

The Legrand logo is a registered trademark
of the Legrand group of companies.